

GENERAL CATALOG

SUMMARY



GENERAL CATALOG

SUMMARY



Symbols & Nomenclatures

Símbolos y Nomenclaturas

Nomenclatures / Nomenclaturas		
C3	Internal clearance greater than normal	Juego radial mayor que el normal
C4	Internal clearance greather than C3	Juego radial mayor que C3
M	Machined brass cage	Jaula de latón
N	Snap ring groove in outer ring	Ranura en aro exterior
NR	Snap ring groove and snap ring in outer ring	Ranura y anillo elástico en aro exterior
P	Polyamide cage	Jaula de poliamida
RS	Rubbing seal on one side	Tapa retén en una cara
ZRS	Rubbing seals on both sides	Tapa retén en las dos caras
Z	Shield on one side	Tapa en una cara
ZZ	Shields on both sides	Tapas en las dos caras
Symbols / Símbolos		
	New reference	Nueva referencia
	Active ABS	ABS activo
	Passive ABS	ABS pasivo
Abbreviations / Abreviaturas		
	Differential	Diferencial
	Gearbox	Caja de Cambios
	Wheel end	Rueda
AC	Air Conditioning	Aire Acondicionado
ALT	Alternator	Alternador
CL	Clutch	Embrague
KP	King Pin	Pivote de mangueta
SB	Satellit Box	Planetario
SM	Suporte mola	Suporte mola
SS	Suspensión	Suspensión
ST	Steering	Dirección
V	Various	Varios

Index

Índice

01 \	Single row tapered roller bearings Rodamientos de rodillos cónicos	6
02 \	Double row tapered roller bearings Rodamientos de rodillos cónicos de doble hilera	50
03 \	Thrust tapered roller bearings Rodamientos axiales cónicos	58
04 \	Deep groove ball bearings Rodamientos radiales de bolas	62
05 \	Angular contact ball bearings Rodamientos de bolas de contacto angular	80
06 \	Thrust ball bearings Rodamientos axiales de bolas	102
07 \	Insert bearings Rodamientos autoalineables	108
08 \	Cylindrical roller bearings Rodamientos de rodillos cilíndricos	112
09 \	Special needle roller bearings Rodamientos de agujas especiales	126
10 \	Wheel end hub units Unidades de buje	134
11 \	F-Box Rebuild Kit Kit de reparación F-Box	148
12 \	Passenger car wheel bearing kits Kits de rueda para turismos	156
13 \	Fersa Accessories Accesorios Fersa	176
14 \	Lists & Cross part number Listados y cruces de referencias	184

GENERAL CATALOG

SUMMARY

OUR NEW CATALOG HAS THE COMPLETE INFORMATION OF OUR CURRENT BEARING PRODUCTS, AS WELL AS OUR NEW PART NUMBERS AND PRODUCT LINES.

CON ESTE NUEVO CATÁLOGO FERSA LES FACILITA UNA COMPLETA INFORMACIÓN SOBRE TODOS LOS RODAMIENTOS QUE ACTUALMENTE TENEMOS EN NUESTRA GAMA INCLUYENDO NUEVAS FAMILIAS Y REFERENCIAS.



Thanks to the efforts of our R&D department, together with our customers' collaboration, we have increased our new part numbers, providing better service to our customers and distributors in the five continents.

You will find a cross part numbers list with the sector's main manufacturers, as well as a list by dimensions, for easier identification, in the catalog's last pages.

Please visit our webpage for the latest updated information

www.fersa.com

We hope this information is of service to you.



Gracias al esfuerzo de nuestro departamento de I+D y a la estrecha colaboración con nuestros clientes hemos conseguido incrementar el número de referencias para dar el mejor servicio posible a nuestros clientes y distribuidores en los cinco continentes.

La parte final contiene un completo listado de cruces de nuestras referencias con los principales fabricantes del mercado, así como un listado dimensional para facilitar su identificación.

Les invitamos a consultar nuestra web:

www.fersa.com

donde encontrarán la información actualizada.

Esperamos que esta información sea de su interés.

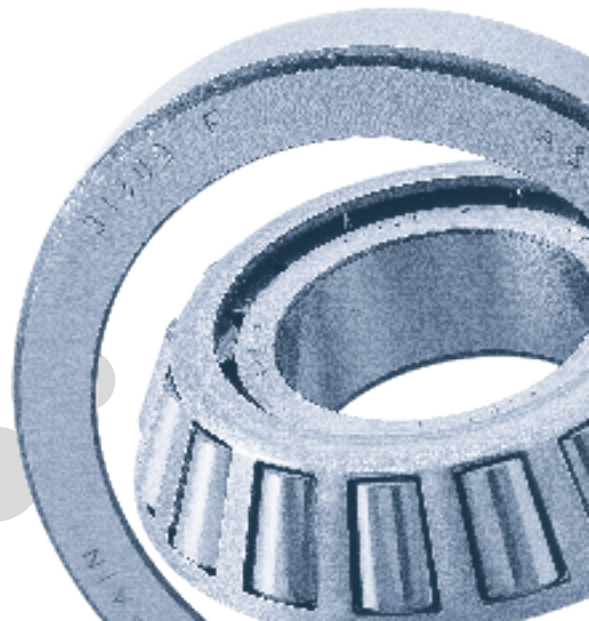

Single row tapered roller bearing

Rodamientos de rodillos cónicos

01.1 \	Metric series / Series métricas	8
01.2 \	Inch series / Series pulgadas	14
01.3 \	Special design bearings / Serie especial	32
01.4 \	Flange side bearings / Rodamientos con valona	42
01.5 \	U type bearings / Rodamientos tipo U	44
01.6 \	Steering bearings / Rodamientos de dirección	46
01.7 \	Interior Sets / Conjuntos interiores	48

01

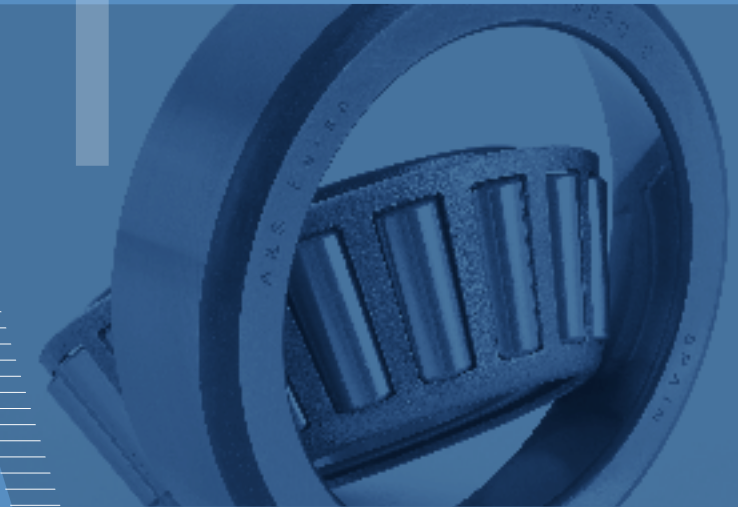

01.1 \ Metric series Series métricas



Fersa	d (mm)	D (mm)	T (mm)
302 SERIES			
30202 F	15,000	35,000	11,750
30203 F	17,000	40,000	13,250
30204 F	20,000	47,000	15,250
30205 F	25,000	52,000	16,250
30205 FR	25,000	52,000	16,250
30206 F	30,000	62,000	17,250
30207 F	35,000	72,000	18,250
30207/37 F	37,000	72,000	18,250
30207/80 F	35,000	80,000	18,250
30208 F	40,000	80,000	19,750
30209 F	45,000	85,000	20,750
30210 F	50,000	90,000	21,750
30211 F	55,000	100,000	22,750
30212 F	60,000	110,000	23,750
30213 F	65,000	120,000	24,750
30214 F	70,000	125,000	26,250
30215 F	75,000	130,000	27,250
30216 F	80,000	140,000	28,250
30217 F	85,000	150,000	30,500
30218 F	90,000	160,000	32,500
30219 F	95,000	170,000	34,500
30220 F	100,000	180,000	37,000
30221 F	105,000	190,000	39,000
30222 F	110,000	200,000	41,000
30224 F	120,000	215,000	43,500
30226 F	130,000	230,000	43,750

303 SERIES			
303/28 F	28,000	68,000	19,750
30302 F	15,000	42,000	14,250
30303 F	17,000	47,000	15,250
30304 F	20,000	52,000	16,250
30305 F	25,000	62,000	18,250
30306 F	30,000	72,000	20,750
30307 F	35,000	80,000	22,750

Fersa	d (mm)	D (mm)	T (mm)
30308 F	40,000	90,000	25,250
30309 F	45,000	100,000	27,250
30310 F	50,000	110,000	29,250
30311 F	55,000	120,000	31,500
30312 F	60,000	130,000	33,500
30313 F	65,000	140,000	36,000
30314 F	70,000	150,000	38,000
30315 F	75,000	160,000	40,000
30316 F	80,000	170,000	42,500

313 SERIES

31303 F	17,000	47,000	15,250
31305 F	25,000	62,000	18,250
31306 F	30,000	72,000	20,750
31307 F	35,000	80,000	22,750
31308 F	40,000	90,000	25,250
31309 F	45,000	100,000	27,250
31310 F	50,000	110,000	29,250
31311 F	55,000	120,000	31,500
31312 F	60,000	130,000	33,500
31313 F	65,000	140,000	36,000
31314 F	70,000	150,000	38,000
31315 F	75,000	160,000	40,000
31316 F	80,000	170,000	42,500
31318 F	90,000	190,000	46,500

320 SERIES

320/22 XF	22,000	44,000	15,000
320/28 XF	28,000	52,000	16,000
320/32 XF	32,000	58,000	17,000
320/32 XR	32,000	58,000	17,000
32004 XF	20,000	42,000	15,000
32004 XR	20,000	42,000	15,000
32005 XF	25,000	47,000	15,000
32005 XR	25,000	47,000	15,000
32006 XF	30,000	55,000	17,000
32007 X 30/32007 XF	30,000	62,000	18,000

01.1 \ Metric series Series métricas



Fersa	d (mm)	D (mm)	T (mm)
320 SERIES			
32007 X 34/32007 XF	34,000	62,000	18,000
32007 XF	35,000	62,000	18,000
32007 XR	35,000	62,000	18,000
32008 XF	40,000	68,000	19,000
32009 XF	45,000	75,000	20,000
32009 XR	45,000	75,000	20,000
32010 XF	50,000	80,000	20,000
32010 XR	50,000	80,000	20,000
32011 XF	55,000	90,000	23,000
32012 XF	60,000	95,000	23,000
32013 XF	65,000	100,000	23,000
32014 XF	70,000	110,000	25,000
32015 XF	75,000	115,000	25,000
32016 XF	80,000	125,000	29,000
32017 XF	85,000	130,000	29,000
32018 XF	90,000	140,000	32,000
32019 XF	95,000	145,000	32,000
32020 XF	100,000	150,000	32,000
32021 XF	105,000	160,000	35,000
32022 XF	110,000	170,000	38,000
32024 XF	120,000	180,000	38,000
32026 XF	80,000	125,000	29,000
32028 XF	140,000	210,000	45,000

322 SERIES			
32204 F	20,000	47,000	19,250
32204 FR	20,000	47,000	19,250
32205 BF	25,000	52,000	19,250
32205 F	25,000	52,000	19,250
32206 F	30,000	62,000	21,250
32207 F	35,000	72,000	24,250
32208 F	40,000	80,000	24,750
32209 F	45,000	85,000	24,750
32210 F	50,000	90,000	24,750
32211 F	55,000	100,000	26,750
32212 F	60,000	110,000	29,750

Fersa	d (mm)	D (mm)	T (mm)
32213 F	65,000	120,000	32,750
32214 F	70,000	125,000	33,250
32215 F	75,000	130,000	33,250
32216 F	80,000	140,000	35,250
32217 F	85,000	150,000	38,500
32218 F	90,000	160,000	42,500
32219 F	95,000	170,000	45,500
32220 F	100,000	180,000	49,000
32220 FR	100,000	180,000	49,000
32221 F	105,000	190,000	53,000
32222 F	110,000	200,000	56,000

323 SERIES			
323/38 F	38,000	90,000	35,250
32304 F	20,000	52,000	22,250
32305 F	25,000	62,000	25,250
32306 BF	30,000	72,000	28,750
32306 C	30,000	72,000	28,750
32306 F	30,000	72,000	28,750
32307 F	35,000	80,000	32,750
32308 C	40,000	90,000	35,250
32308 F	40,000	90,000	35,250
32309 BF	45,000	100,000	38,250
32309 F	45,000	100,000	38,250
32310/55	55,000	110,000	42,250
32310 F	50,000	110,000	42,250
32311 F	55,000	120,000	45,500
32312 BF	60,000	130,000	48,500
32312 F	60,000	130,000	48,500
32313 BF	65,000	140,000	51,000
32313 F	65,000	140,000	51,000
32314 BF	70,000	150,000	54,000
32314 F	70,000	150,000	54,000
32315 F	75,000	160,000	58,000
32316 F	80,000	170,000	61,500
32317 F	85,000	180,000	63,500

01.1 \ Metric series Series métricas



Fersa	d (mm)	D (mm)	T (mm)
329 SERIES			
32911 F	55,000	80,000	17,000
32924 F	120,000	165,000	29,000

330 SERIES			
33006 F	30,000	55,000	20,000
33010 F	50,000	80,000	24,000
33011 F	55,000	90,000	27,000
33013 F	65,000	100,000	27,000
33014 F	70,000	110,000	31,000
33015 F	75,000	115,000	31,000
33016 F	80,000	125,000	36,000
33017 F	85,000	130,000	36,000
33018 F	90,000	140,000	39,000
33019 F	95,000	145,000	39,000
33020 F	100,000	150,000	39,000
33020 F 561694	100,000	150,000	39,000
33021 F	105,000	160,000	43,000
33021 F 0266488	105,000	160,000	43,000
33022 F	110,000	170,000	47,000

331 SERIES			
33108 F	40,000	75,000	26,000
33109 F	45,000	80,000	26,000
33110 F	50,000	85,000	26,000
33111 F	55,000	95,000	30,000
33112 F	60,000	100,000	30,000
33113 F	65,000	110,000	34,000
33114 F	70,000	120,000	37,000
33115 F	75,000	125,000	37,000
33116 F	80,000	130,000	37,000
33117 F	85,000	140,000	41,000
33118 F	90,000	150,000	45,000

01.2 \ Inch series

Series pulgadas



Fersa	d (mm)	D (mm)	T (mm)
4 A/6	19,050	44,450	12,700
336/332	41,275	80,000	21,000
342 A/332	41,275	80,000	28,574
344/332	40,000	80,000	21,000
355 X/352	44,450	90,119	23,000
359 A/354 X	46,038	85,000	20,638
359 S/354 X	46,038	85,000	20,638
365/362	50,000	90,000	20,000
368 A/362 A	50,800	88,900	20,638
368 A/362 X	50,800	90,000	25,000
368 S/362	51,592	90,000	20,000
368 S/362 A	51,592	88,900	20,638
369 A/362 A	47,625	88,900	20,638
369 A/363	47,625	90,000	20,000
369 S/362	47,625	90,000	20,000
369 S/362 A	47,625	88,900	20,638
369 S/363	47,625	90,000	20,000
385/382	55,000	98,425	21,000
385/382 A	55,000	96,838	21,000
385 A/382	50,800	98,425	21,000
385 A/382 A	50,800	96,838	21,000
386 A/382 A	47,625	96,838	21,000
387/382	57,150	98,425	21,000
387/382 A	57,150	96,838	21,000
387/382 S	57,150	96,838	25,400
387 A/382	57,150	98,425	21,000
387 A/382 A	57,150	96,838	21,000
387 A/382 S	57,150	96,838	25,400
387 A/383 A	57,150	100,000	21,000
387 AS/382 A	57,150	96,838	21,000
387 AS/382 S	57,150	96,838	25,400
387 S/382	57,150	98,425	21,000
387 S/382 S	57,150	96,838	25,400
387 S/383 A	57,150	100,000	21,000
388 A/382	57,531	98,425	21,000
389 A/382 A	53,975	96,838	21,000

Fersa	d (mm)	D (mm)	T (mm)
389 A/383 A	53,975	100,000	21,000
389 AS/382	53,975	98,425	21,000
390/394 A	57,150	110,000	22,000
392/394 A	61,912	110,000	22,000
395/394 A	63,500	110,000	22,000
395 A/394 A	66,675	110,000	22,000
395 S/394 A	66,675	110,000	22,000
399 A/394 A	68,262	110,000	22,000
399 AS/394 A	68,262	110,000	22,000
418/414	38,100	88,500	26,988
419/414	41,275	88,500	26,988
455/453 X	50,800	104,775	30,162
462/453 X	57,150	104,775	30,162
462 A/453 X	57,150	104,775	30,162
469/453 X	57,150	104,775	30,162
476/472	60,000	120,000	29,795
482/472	69,850	120,000	29,795
482/472 A	69,850	120,000	29,002
482/472 X	69,850	123,825	30,162
482 E/472	69,850	120,000	46,751
484/472	70,000	120,000	29,795
484/472 A	70,000	120,000	29,002
495/492	82,550	133,350	33,338
495/492 A	82,550	133,350	30,162
495/493	82,550	136,525	30,162
495 A/492 A	76,200	133,350	30,162
495 A/493	76,200	136,525	30,162
496/493	80,962	136,525	30,162
497/492 A	85,725	133,350	30,162
497/493	85,725	136,525	30,162
498/492 A	84,138	133,350	30,162
498/493	84,138	136,525	30,162
527/522	44,450	101,600	34,925
527 S/522	44,983	101,600	34,925
528/522	47,625	101,600	34,925
529/520 X1	50,800	100,000	34,925

01.2 \ Inch series

Series pulgadas



Fersa	d (mm)	D (mm)	T (mm)
529/522	50,800	101,600	34,925
529 X/522	50,800	101,600	34,925
536/532 X	47,625	107,950	36,512
537/532 X	50,800	107,950	36,512
538/532	54,988	111,125	38,100
N 538/532 A	54,990	111,130	38,100
539/532 A	53,975	111,125	38,100
539/532 X	53,975	107,950	36,512
555 S/552 A	57,150	123,825	38,100
N 557 S/552 A	53,970	123,820	38,100
559/552 A	63,500	123,825	38,100
566/563	69,850	127,000	36,512
567/563	73,025	127,000	36,512
567 X/563	73,025	127,000	36,512
568/563	73,817	127,000	36,512
575/572	76,200	139,992	36,512
575/572 A	53,970	123,820	38,100
575/572 X	76,200	139,700	36,512
576/572	73,025	139,992	36,512
580/572	82,550	139,992	36,512
582/572	82,550	139,992	36,513
580/572 A	82,550	139,982	35,250
580/572 X	82,550	139,700	36,512
594/592 A	95,250	152,400	39,688
594/593 X	95,250	150,000	35,992
594 A/592 A	95,250	152,400	39,688
594 A/593 X	95,250	150,000	35,992
598/592 A	92,075	152,400	39,688
598 A/592 A	92,075	152,400	39,688
598 A/593 X	92,075	150,000	35,992
619/612	50,800	120,650	41,275
621/612	53,975	120,650	41,275
641/632	66,675	136,525	41,275
641/633	66,675	130,175	41,275
644/632	71,438	136,525	41,275
659/653	76,200	146,050	41,275

Fersa	d (mm)	D (mm)	T (mm)
663/653	82,550	146,050	41,275
665/653	85,000	146,000	41,000
665 A/653	85,725	146,050	41,275
681/672	92,075	168,275	41,275
681 A/672	92,075	168,275	41,275
683/672	95,250	168,275	41,275
687/672	101,600	168,275	41,275
740/742	80,962	150,089	44,450
749/742	85,026	150,089	44,450
749 A/742	82,550	150,089	44,450
749 S/742	85,026	150,089	44,450
759/752	88,900	161,925	47,625
1280/1220	22,225	57,150	22,225
1380/1328	22,225	52,388	19,368
1680/1620	33,338	66,675	20,638
1779/1729 X	23,812	56,896	19,368
1780/1729	25,400	56,896	19,368
1985/1922	28,575	57,150	19,845
1985/1930	28,575	56,896	19,845
1985/1931	28,575	60,325	19,845
1985/1932	28,575	58,738	19,050
1986/1931	25,400	60,325	19,845
1986/1932	25,400	58,738	19,050
1988/1922	28,575	57,150	19,845
1988/1931	28,575	60,325	19,845
2580/2520	31,750	66,421	25,400
2580/2523	31,750	69,850	23,812
2585/2523	33,338	69,850	23,812
2689/2631	28,575	66,421	23,812
2780/2720	36,487	76,200	23,812
2780/2729	36,487	76,200	23,812
2788/2720	38,100	76,200	23,812
2788/2729	38,100	76,200	23,812
2789/2720	39,688	76,200	23,812

01.2 \ Inch series

Series pulgadas



Fersa	d (mm)	D (mm)	T (mm)
2789/2729	39,688	76,200	23,812
3381/3320	38,100	80,167	29,370
3382/3320	39,688	80,167	29,370
3384/3320	41,275	80,167	29,370
3386/3320	39,688	80,167	29,370
3386/3325	39,688	79,975	29,370
3477/3420	33,338	79,375	29,370
3478/3420	34,925	79,375	29,370
3490/3420	38,100	79,375	29,370
3577/3520	41,275	84,138	30,162
3577/3525	41,275	87,312	30,162
3578/3520	44,450	84,138	30,162
3578/3525	44,450	87,312	30,162
3585/3525	41,275	87,312	30,162
3586/3525	45,237	79,975	30,162
3767/3720	52,388	93,264	30,162
3775/3720	50,800	93,264	30,162
3776/3720	44,983	93,264	30,162
3778/3720	47,625	93,264	30,162
3780/3720	50,800	93,264	30,162
3780/3727	50,800	93,662	30,162
3782/3720	44,450	93,264	30,162
3784/3720	50,800	93,264	30,162
3784/3727	50,800	93,662	30,162
3872/3820	34,000	85,000	30,000
3877/3820	41,275	85,725	30,162
3878/3820	36,512	85,725	30,162
3980/3920	60,325	112,712	30,162
3982/3920	63,500	112,712	30,162
3982/3927 X	63,500	110,000	30,162
3984/3920	66,675	112,712	30,162
3984/3925	66,675	112,712	30,162
3994/3920	66,675	112,712	30,162
3994/3927 X	66,675	110,000	30,162
3979/JM 511910	57,150	110,000	29,000

Fersa	d (mm)	D (mm)	T (mm)
JF 4049/JF 4010	40,000	85,000	33,000
4367 X/4335	39,688	90,488	39,688
4388/4335	41,275	90,488	39,688
JF 4549/JF 4510	45,000	95,000	36,000
JW 4549/JW 4510	45,000	95,000	29,000
4580/4535	50,800	104,775	39,687
JF 5049/JF 5010	50,000	100,000	36,000
JW 5049/JW 5010	50,000	105,000	32,000
5395/5335	49,212	103,188	43,658
JW 5549/JW 5510	55,000	115,000	34,000
5566/5535	55,562	122,238	43,658
5760/5735	76,200	135,733	44,450
JF 6049/JF 6010	60,000	115,000	40,000
JW 6049/JW 6010	60,000	125,000	37,000
A 6075/A 6157	19,050	39,992	12,014
6280/6220	53,975	127,000	50,800
6379/6320	65,088	135,755	53,975
6386/6320	66,675	135,755	53,975
6461/6420	76,200	149,225	53,975
6461 A/6420	76,200	149,220	53,970
JD 6549/JD 6510	65,000	110,000	31,000
JF 7049/JF 7010	70,000	130,000	43,000
JF 7049 A/JF 7010	70,000	130,000	43,000
JW 7049/JW 7010	70,000	140,000	39,000
JW 8049/JW 8010	80,000	160,000	45,000
9278/9220	68,262	161,925	49,212
9285/9220	76,200	161,925	49,212
9380/9321	73,000	171,000	49,000
JF 9549/JF 9510	95,000	160,000	46,000
02474/02420	28,575	68,262	22,225
02475/02420	31,750	68,262	22,225
02872/02820	28,575	73,025	22,225
05066/05185	16,993	47,000	14,382
07087/07204	22,225	51,994	15,011
07087/07210 X	22,225	50,800	15,011

01.2 \ Inch series

Series pulgadas



Fersa	d (mm)	D (mm)	T (mm)
07087 X/07210 X	22,225	50,800	15,011
07097/07204	25,000	51,994	15,011
07100/07196	25,400	50,005	13,495
07100/07204	25,400	51,994	15,011
07100 S/07196	25,400	50,005	13,495
07100 S/07210 X	25,400	50,800	15,011
09067/09195	19,050	49,225	18,034
09067/09196	19,050	49,225	21,209
09074/09194	19,050	49,225	23,020
09074/09195	19,050	49,225	19,845
09074/09196	19,050	49,225	23,020
09081/09195	20,625	49,225	19,845
09081/09196	20,625	49,225	23,020
JF 10049/JF 10010	100,000	165,000	47,000
JP 10049/JP 10010	100,000	145,000	24,000
N JP 10049/JP 10010 A	100,000	145,000	24,000
11162/11300	41,275	76,200	18,009
11163/11300	41,275	76,200	18,009
11590/11520	15,875	42,862	14,288
LM 11749/LM 11710	17,462	39,878	13,843
LM 11949/LM 11910	19,050	45,237	15,494
LM 11949 RS/LM 11910	19,050	45,237	15,494
JP 12049/JP 12010	120,000	170,000	27,000
JP 12049 A/JP 12010	120,000	170,000	27,000
M 12649/M 12610	21,430	50,005	17,526
M 12649 F/M 12610 F	21,430	50,005	17,026
LM 12748/LM 12710	21,430	45,237	15,494
LM 12749/LM 12710	21,986	45,237	15,494
LM 12749/LM 12711	21,986	45,974	15,494
JP 13049/JP 13010	130,000	185,000	29,000
13685/13621	38,100	69,012	19,050
13686/13621	38,100	69,010	26,190
13687/13620	38,100	69,012	19,050
13687/13621	38,100	69,012	19,050
14116/14276	30,226	69,012	19,845

Fersa	d (mm)	D (mm)	T (mm)
14118/14274	30,000	69,012	19,845
14118/14283	30,000	72,085	22,385
14123 AA/14274	31,750	69,012	26,983
14123 AA/14276	31,750	69,012	26,983
14125 A/14274	31,750	69,012	19,845
14125 A/14276	31,750	69,012	19,845
14125 A/14283	31,750	72,085	22,385
14130/14274	33,338	69,012	19,845
14130/14276	33,338	69,012	19,845
14131/14274	33,338	69,012	19,845
14131/14276	33,338	69,012	19,845
14136 A/14276	34,925	69,012	26,983
14137 A/14274	34,925	69,012	19,845
14137 A/14276	34,925	69,012	19,845
14137 AS/14276	34,925	69,012	19,845
14138 A/14274	34,925	69,012	19,845
14138 A/14276	34,925	69,012	19,845
14138 A/14283	34,925	72,085	22,385
14585/14525	34,925	68,262	20,638
15100/15245	25,400	62,000	19,050
15100/15250	25,400	63,500	20,638
15100/15250 X	25,400	63,500	20,638
15101/15245	25,400	62,000	19,050
15101/15250	25,400	63,500	20,638
15101/15250 X	25,400	63,500	20,638
15103/15243	26,000	61,000	19,000
15103/15244	26,000	62,000	19,000
15103/15245	26,000	62,000	19,000
15103/15250	26,000	63,000	20,000
15103/15250 X	26,000	63,000	20,000
15103 S/15243	26,162	61,912	19,050
15103 S/15245	26,162	62,000	19,050
15106/15245	26,988	62,000	19,050
15106/15250	26,988	63,500	20,638

01.2 \ Inch series

Series pulgadas

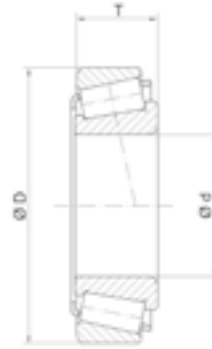

Fersa	d (mm)	D (mm)	T (mm)
15106/15250 X	26,988	63,500	20,638
15112/15245	28,575	62,000	19,050
15112/15250	28,575	63,500	20,638
15112/15250 X	28,575	63,500	20,638
15117/15245	29,987	62,000	19,050
15118/15245	30,213	62,000	19,050
15118/15250	30,213	63,500	20,638
15118/15250 X	30,213	63,500	20,638
15123/15244	31,750	62,000	19,749
15123/15245	31,750	62,000	18,161
15123/15250 X	31,750	63,500	19,749
15126/15245	31,750	62,000	19,050
15126/15250 X	31,750	63,500	20,638
15578/15520	25,400	57,150	17,462
15579 X/15520	25,987	57,150	17,462
15580/15520	26,988	57,150	17,462
J 15585/15520	28,000	57,150	17,462
16150/16284	38,100	72,238	20,638
17887/17831	45,230	79,985	19,842
18590/18520	41,275	73,025	16,667
18690/18620	46,038	79,375	17,462
18790/18720	50,800	85,000	17,462
19150/19268	38,100	68,262	15,875
21075/21212	19,050	53,975	22,225
23690/23620	34,925	73,025	26,988
24780/24720	41,275	76,200	22,225
24780/24721	41,275	76,200	25,400
24781/24720	41,275	76,200	22,225
24781/24721	41,275	76,200	25,400
25576/25520	42,862	82,931	23,812
25577/25520	42,875	82,931	23,812
25577/25521	42,875	83,058	23,812
25577/25522	42,875	83,058	23,876
25577/25523	42,875	82,931	26,988

Fersa	d (mm)	D (mm)	T (mm)
25578/25520	42,862	82,931	23,812
25578/25521	42,862	83,058	23,812
25578/25522	42,862	83,058	23,876
25578/25523	42,862	82,931	26,988
25580/25520	44,450	82,931	23,812
25580/25521	44,450	83,058	23,812
25580/25522	44,450	83,058	23,876
25580/25523	44,450	82,931	26,988
25581/25520	44,450	82,931	23,813
25584/25520	44,983	82,931	23,812
25584/25521	44,983	83,058	23,813
25584/25547 RB	44,983	99,995	25,400
25584 A/25520	44,987	82,931	23,812
25590/25520	45,618	82,931	23,812
25590/25521	45,618	83,058	23,812
25590/25522	45,618	83,058	23,876
25590/25523	45,618	82,931	26,988
25877/25820	34,925	73,025	23,812
25877/25821	34,925	73,025	23,812
25878/25820	34,925	73,025	23,812
25880/25820	36,487	73,025	23,812
25880/25821	36,487	73,025	23,812
JL 26749 F/JL 26710	32,000	53,000	14,500
26878/26823	38,100	76,200	25,400
26882/26820	41,275	80,167	25,400
26882/26822	41,275	79,375	23,812
26884/26823	42,875	76,200	25,400
27687/27620	82,550	125,412	25,400
27690/27620	83,345	125,412	25,400
27695/27620	85,000	125,412	25,400
28137/28317	34,925	80,035	21,433
28579/28520	49,987	89,980	24,750
28580/28520	50,800	89,980	24,750
28580/28521	50,800	92,075	24,608
28580/28527 RB	50,800	99,995	24,607

01.2 \ Inch series

Series pulgadas



Fersa	d (mm)	D (mm)	T (mm)
28584/28521	52,388	92,075	24,608
28680/28622	55,560	97,630	24,600
28682/28621	57,150	96,838	24,608
28682/28622	57,150	97,630	24,608
28985/28920	60,325	101,600	25,400
28985/28921	60,325	100,000	25,400
29585/29520	63,500	107,950	25,400
29586/29520	63,500	107,950	25,400
29586/29522	63,500	107,950	25,400
29590/29520	66,675	107,950	25,400
29590/29522	66,675	107,950	25,400
29675/29620	69,850	112,712	25,400
29675/29630	69,850	120,650	25,400
29685/29620	73,025	112,712	25,400
29688/29620	73,000	112,000	25,000
LM 29748/LM 29710	38,100	65,088	18,034
LM 29748/LM 29711	38,100	65,088	18,034
LM 29749/LM 29710	38,100	65,088	18,034
LM 29749/LM 29711	38,100	65,088	19,812
31593/31520	34,925	76,200	29,370
31594/31520	34,925	76,200	29,370
33262/33462	66,675	117,475	30,162
33262 A/33461	66,675	117,475	30,163
33275/33462	69,850	117,475	30,162
33275/33472	69,850	120,000	29,794
33281/33462	71,438	117,475	30,162
33281/33472	71,438	120,000	29,794
33287/33462	73,025	117,475	30,162
33287/33472	73,025	120,000	29,794
33885/33822	44,450	95,250	27,783
33889/33821	50,800	95,250	27,783
33889/33822	50,800	95,250	27,783
33891/33821	52,388	95,250	27,783
33895/33821	53,975	95,250	27,783
33895/33822	53,975	95,250	27,783

Fersa	d (mm)	D (mm)	T (mm)
34300/34478	76,200	121,442	24,608
34300/34500	76,200	127,000	26,988
34301/34500	76,200	127,000	26,988
34306/34478	77,788	121,442	24,608
37425/37625	107,950	158,750	23,020
37431/37625	109,538	158,750	23,020
37431 A/37625	109,538	158,750	23,020
39250/39412	63,500	104,775	21,433
39580/39520	57,150	112,712	30,162
39580/39528	57,150	119,985	32,750
39581/39520	57,150	112,712	30,162
39585/39520	63,500	112,712	30,162
39590/39520	66,675	112,712	30,162
41125/41286	28,575	72,626	24,608
42350/42584	88,900	148,430	28,575
42362/42584	92,075	148,430	28,575
42368/42584	93,662	148,430	28,575
42381/42584	96,838	148,430	28,575
42688/42620	76,200	127,000	30,162
43112/43312	28,000	79,000	25,000
44131/44348	33,000	88,000	25,000
44162/44348	41,275	88,500	25,400
L 44643/L 44610	25,400	50,292	14,224
L 44643 RS/L 44610	25,400	50,292	14,224
L 44645/L 44613	25,987	51,986	15,011
L 44649/L 44610	26,988	50,292	14,224
45280/45220	44,450	104,775	30,162
45284/45220	50,800	104,775	30,162
45285 A/45220	50,800	104,775	30,162
45285 A/45221	50,800	104,775	30,162
45289/45220	57,150	104,775	30,162
45291/45220	57,150	104,775	30,162
L 45449/L 45410	29,000	50,292	14,224
47487/47420	69,850	120,000	32,545
47490/47420	71,438	120,000	32,545

01.2 \ Inch series

Series pulgadas



Fersa	d (mm)	D (mm)	T (mm)
47686/47620	82,550	133,350	33,338
47687/47623 A	82,550	136,525	44,450
47679/47620	76,200	133,350	30,162
47890/47820	92,075	146,050	33,338
48190/48120	107,950	161,925	34,925
48290/48220	127,000	182,562	39,689
48684/48620	142,875	200,025	41,275
LM 48548/LM 48510	34,925	65,088	18,034
LM 48548/LM 48514 XP	34,925	68,262	18,034
LM 48548 RS/LM 48510	34,925	65,088	18,034
49162/49368	41,275	93,662	31,750
49175/49368	44,450	93,662	31,750
49585/49520	50,800	101,600	31,750
52400/52618	101,600	157,162	36,512
53176/53375	44,450	95,250	30,958
53177/53375	44,450	95,250	30,958
N 53178/53375	44,450	95,250	30,958
53178/53377	44,450	95,250	30,958
55175 C/55437	44,450	111,125	30,162
55187 C/55437	47,625	111,125	30,162
55200 C/55437	50,800	111,125	30,162
55206 C/55437	52,388	111,125	30,162
55212 C/55437	53,970	111,120	30,160
56425/56650	107,950	165,100	36,512
59162/59412	41,275	104,775	36,512
59175/59412	44,450	104,775	36,512
64450/64700	114,300	177,800	41,275
65237/65500	60,325	127,000	44,450
66589/66520	59,972	122,238	33,338
LM 67048/LM 67010	31,750	59,131	15,875
LM 67048/LM 67014	31,750	61,986	15,875
LM 67048/LM 67014 X	31,750	61,986	15,875
LM 67048 RS/LM 67010	31,750	59,131	15,875
LM 67049/LM 67011	31,750	59,131	17,780
LM 67049 A/LM 67010	31,750	59,131	15,875

Fersa	d (mm)	D (mm)	T (mm)
LM 67049 A/LM 67014	31,750	61,986	15,875
67885/67820	190,500	266,700	47,625
JL 68145/JL 68111 Z	35,000	60,000	15,875
L 68149/L 68110	34,987	59,131	15,875
L 68149/L 68111	34,987	59,975	15,875
L 68149/L 68116	34,987	65,088	15,875
L 68149 R/L 68110	34,987	59,131	15,875
68462/68712	117,475	180,975	34,925
JL 69345/JL 69310 Z	38,000	63,000	17,000
JL 69349/JL 69310	38,000	63,000	17,000
69354/69630	89,992	160,096	30,124
72187/72487	47,625	123,825	36,512
72187 C/72487	47,000	123,000	36,000
72200 C/72487	50,800	123,825	36,512
72212/72487	53,975	123,825	36,512
72212 C/72487	53,975	123,825	36,512
72218 C/72487	55,562	123,825	36,512
72225 C/72487	57,150	123,825	36,512
77375/77675	95,000	171,000	47,000
78215 C/78551	53,975	140,030	36,513
78225 C/78551	57,150	140,030	36,513
LM 78349/LM 78310 A	34,987	61,975	16,700
HM 81649/HM 81610	15,987	46,975	21,000
M 84249/M 84210	25,400	59,530	23,368
M 84548/M 84510	25,400	57,150	19,431
M 86647/M 86610	28,575	64,292	21,433
M 86648 A/M 86610	30,955	64,292	21,432
M 86649/M 86610	30,162	64,292	21,433
M 88043/M 88010	30,162	68,262	22,225
M 88043/M 88011	30,162	68,262	22,225
M 88046/M 88010	31,750	68,262	22,225
M 88048/M 88010	33,338	68,262	22,225
JHM 88540/JHM 88513	30,000	72,000	29,370
HM 88542/HM 88510	31,750	73,025	29,370

01.2\ Inch series

Series pulgadas

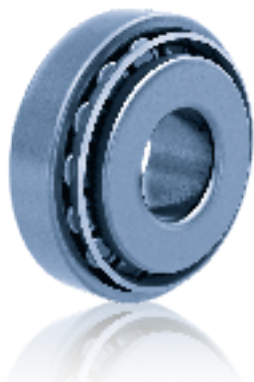

Fersa	d (mm)	D (mm)	T (mm)
HM 88547/HM 88510	33,338	73,025	29,370
HM 88648/HM 88610	35,717	72,233	25,400
HM 88649/HM 88610	34,925	72,233	25,400
HM 89443/HM 89410	33,338	76,200	29,370
N HM 89443/HM 89411	33,338	76,200	29,370
HM 89446/HM 89410	34,925	76,200	29,370
HM 89448/HM 89410	36,512	76,200	29,370
HM 89449/HM 89410	36,512	76,200	29,370
LM 102949/LM 102910	45,242	73,431	19,558
JLM 104945/JLM 104910	50,000	82,000	21,500
JLM 104946/JLM 104910	50,000	82,000	21,500
JLM 104948/JLM 104910	50,000	82,000	21,500
JLM 104948/LM 104911	50,000	82,550	21,500
LM 104949/JLM 104910	50,800	82,000	21,976
LM 104949/LM 104911	50,800	82,550	21,976
LM 104949/LM 104912	50,800	82,931	21,590
HM 204043/HM 204010	39,987	90,975	32,000
JM 205149/JM 205110	50,000	90,000	28,000
JM 207049/JM 207010	55,000	95,000	29,000
JM 207049 A/JM 207010	55,000	95,000	29,000
JH 211749/JH 211710	65,000	120,000	39,000
HM 212044/HM 212011	60,325	122,238	38,100
HM 212047/HM 212011	63,500	122,238	38,100
HM 212049/HM 212010	66,675	122,238	38,100
HM 212049/HM 212011	66,675	122,238	38,100
H 212749/H 212710	65,987	123,975	41,500
HM 215249/HM 215210	75,987	131,975	39,000
LL 217849/LL 217810	88,900	121,442	15,083
HM 218248/HM 218210	89,974	146,975	40,000
HM 220149/HM 220110	99,975	156,975	42,000
LM 300849/LM 300811	40,987	67,975	17,500
JHM 318448/JHM 318410	90,000	155,000	44,000
LL 319349/LL 319310	95,250	128,587	15,875
LM 330448/LM 330410	152,400	203,200	41,275
H 414242/H 414210	66,675	136,525	41,275

Fersa	d (mm)	D (mm)	T (mm)
H 414245 X/H 414210	68,262	136,525	41,275
LM 501349/LM 501310	41,275	73,431	19,558
LM 501349/LM 501314	41,275	73,431	21,430
LM 503349/LM 503310	45,987	74,976	18,000
LM 503349 A/LM 503310	45,987	74,976	18,000
JLM 506849/JLM 506810	55,000	90,000	23,000
JLM 506849 A/JLM 506811	55,000	90,000	25,000
JLM 508748/JLM 508710	60,000	95,000	24,000
JM 511945/3920	65,000	112,712	29,020
JM 511945/JM 511910	65,000	110,000	28,000
JM 511946/JM 511910	65,000	110,000	28,000
HM 516448 /HM 516414 B	82,550	136,525	12,319
HM 516449 A/HM 516410	82,550	133,350	39,687
HM 516449 C/HM 516410	82,550	133,350	39,688
JHM 516849/JHM 516810	85,000	140,000	39,000
HM 518445/HM 518410	88,900	152,400	39,688
JHM 522649/JHM 522610	110,000	180,000	47,000
JM 515649/JM 515610	80,000	130,000	35,000
LM 603049/LM 603011	45,242	77,788	19,842
LM 603049/LM 603012	45,242	77,788	21,430
LM 603049/LM 603014	45,242	79,975	19,842
JM 612949/JM 612910	70,000	115,000	29,000
L 623149/L 623110	114,300	152,400	21,432
JLM 704649/JLM 704610	50,000	84,000	22,000
JLM 710949 C/JLM 710910	65,000	105,000	24,000
L 713049/L 713010	69,850	101,600	19,050
JLM 714149/JLM 714110	75,000	115,000	25,000
JM 714249/JM 714210	75,000	120,000	31,000
H 715332/H 715311	60,325	136,525	46,038
H 715334/H 715311	61,912	136,525	46,038
H 715336/H 715311	63,500	136,525	46,038
H 715340/H 715311	65,088	136,525	46,038
H 715341/H 715311	66,675	136,525	46,038
H 715343/H 715311	68,262	136,525	46,038

01.2 \ Inch series

Series pulgadas



Fersa	d (mm)	D (mm)	T (mm)
H 715345/H 715311	71,438	136,525	46,038
H 715345/H 715313 W	71,000	136,000	49,000
JM 716649/JM 716610	85,000	130,000	30,000
JM 718149/JM 718110	90,000	145,000	35,000
JM 718149 A/JM 718110	90,000	145,000	35,000
JM 719149/JM 719113	95,000	150,000	35,000
JHM 720249/JHM 720210	100,000	160,000	41,000
JM 720249/JM 720210	100,000	155,000	36,000
HM 801346/HM 801310	38,100	82,550	29,370
HM 801346 X/HM 801310	38,100	82,550	29,370
M 802048/M 802011	41,275	82,550	26,543
HM 803145/HM 803110	41,275	88,900	30,163
HM 803146/HM 803110	41,275	88,900	30,162
HM 803149/HM 803110	44,450	88,900	30,162
M 804048/M 804010	47,625	88,900	25,400
M 804049/M 804010	47,625	88,900	25,400
HM 804840/HM 804810	41,275	95,250	30,162
HM 804843/HM 804810	44,450	95,250	30,162
HM 804846/HM 804810	47,625	95,250	30,162
LM 806649/LM 806610	53,975	88,900	19,050
LM 806649/LM 806610	53,975	88,900	19,050
HM 807040/HM 807010	44,450	104,775	36,512
HM 807044/HM 807010	49,212	104,775	36,512
JHM 807045/JHM 807012	50,000	105,000	37,000
HM 807046/HM 807010	50,800	104,775	36,512
HM 807048/HM 807010	54,487	104,775	36,512
HM 807049/HM 807010	53,975	104,775	36,512
JLM 813049/JLM 813010	70,000	110,000	26,000
HM 813840/HM 813811	55,562	127,000	36,512
HM 813841/HM 813810	60,325	127,000	36,512
HM 813841/HM 813811	60,325	127,000	36,512
HM 813842/HM 813810	63,500	127,000	36,512
HM 813843/HM 813810	61,912	127,000	36,512
N HM 813844/HM 813810	66,670	127,000	36,512

01.3 \ Special design bearings Serie especial



Fersa	d (mm)	D (mm)	T (mm)
F 15001	25,000	62,000	18,250
F 15002	30,000	72,000	20,750
F 15003	40,987	67,975	17,500
F 15014	35,000	80,000	22,750
F 15028	22,000	41,000	14,500
F 15029	29,000	50,292	14,224
F 15036	35,000	60,000	15,875
F 15040	35,000	60,000	13,000
F 15046	60,000	130,000	39,000
F 15047	50,800	100,000	35,000
F 15048	75,000	180,000	63,500
F 15051 C	70,000	130,000	57,000
F 15051 R	70,000	130,000	57,000
F 15054/3720	50,000	93,264	30,162
F 15055/LM 29710	38,100	65,088	18,034
F 15056	28,000	52,000	15,750
F 15063	22,000	47,000	20,750
F 15071	75,000	160,000	58,000

Fersa	CROSS REF.				
F 15001	KOYO	TR 0506 R			
F 15002	KOYO	TRA 0607 R			TOYOTA (Hiace)
F 15003	KOYO	57414 / LM 300811			SUZUKI (SAMURAI SJ413)
F 15014	SKF	30307XR N			SUZUKI
F 15028	SKF TIMKEN	BCAB 326332B JL22349 / 10			FIAT (Palio * Siena)
F 15029	SKF FAG TIMKEN IRB	BT1B 329013 A/Q 572428 XC110240CG / L45410 IR 2562			FORD (Courier * Escort * Fiesta * Ikon * Microbus * Orion * Puma * Street)
F 15036	SKF FAG KOYO IRB	BT1B332541AB / Q 540484 573315 IR 2043			FORD (Escort * Escort Hobby * Sierra * Verona)
F 15040	SKF FAG	BT1 328227 CA/Q 574821 A			FORD (Escort * Fiesta * Orion)
F 15046	SKF FAG	239697 Q 521471 A			SCANIA (R653)
F 15047	SKF FAG TIMKEN	331305A/Q 522380/33211 XGA 33211			ZF (16S-1650)
F 15048	FAG	543562			SCANIA (R770 * R780 * R782 * RP 835) MAN (HY-13110)
F 15051 C	FAG	534565			MERCEDES BENZ (ATEGO * AXOR * MK * NG * SK)
					MERCEDES BENZ (CITARO * CONECTO)
F 15051 R	SKF FAG	331933 528983			MAN (E 2000 * F 90 * F 2000 * M 90 * M 2000 * LION S COACH * LION S STAR)
F 15054/3720	NSK KBC	50KW01 3780 F1			MITSUBISHI (Canter * Elantra)
F 15055/LM 29710	NSK KBC	38KW01C9 RCHL 38KW01C9			HYUNDAI
F 15056	NSK	28KW0165SA			MITSUBISHI
F 15063	SNR	EC 10059			RENAULT
F 15071	SKF FAG	BT1B243150 / QCL7C 540783			VOLVO (EV90 * EV91) SCANIA (RBP830 * RBP831 * RBP 832 * RP830 * RP831 * RP 832)

01.3 \ Special design bearings Serie especial



Fersa	d (mm)	D (mm)	T (mm)
F 15075	88,000	140,000	32,000
F 15076	105,000	170,000	38,000
F 15080	34,925	73,025	26,988
F 15082	65,000	145,000	36,000
F 15083	65,000	145,000	39,500
F 15088	60,000	95,000	27,000
F 15089	22,000	47,000	20,750
F 15104	85,000	150,000	30,500
F 15109	39,688	80,167	29,370
F 15112	42,000	76,000	23,812
F 15114	70,000	150,000	41,275
F 15115	89,975	146,975	40,000
F 15116	70,000	150,000	39,800
F 15117	40,000	90,000	28,750
F 15119	65,000	150,000	38,000
F 15133	57,165	140,000	28,250
F 15156	80,000	140,000	39,250
F 15157	38,100	90,000	35,250
F 15158	60,000	135,000	37,000
F 15159	65,000	165,000	40,000
F 15165	109,538	158,750	23,020
F 15183	65,000	165,000	36,000
F 15184	62,000	147,000	50,000

Fersa	CROSS REF.				
F 15075	SKF FAG	331958 Q 529065			
F 15076	SKF FAG	331126 Q 528946			
F 15080	SKF FAG	330865C / 332046AD 511687			GENERAL MOTORS (Omega * Suprema)
F 15082	SKF FAG	330633 C 509333 A			MERCEDES BENZ (HL5)
F 15083	SKF FAG	331075 521618			MERCEDES BENZ (HL5)
F 15088	NTN	CR 1252			NISSAN (Junior)
F 15089	SKF FAG SNR	1861071 528935 EC 10059			RENAULT (4 * 5)
F 15104	SKF	30217J2/QVB478			ZF (16S-151 * 16S-181 * 16S-221 * 16S-251)
F 15109	KOYO	57620			FULLER (RTLO 16918)
F 15112	KOYO	ST 4276 C / ST 4276 A			FULLER (RTO 13707DLL)
F 15114	TIMKEN	NP 550563 / NP 546683			ZF (AV 132)
F 15115	FAG	580779 A			FRUEHAUF (SMB)
F 15116	SKF	BT1B 329012			VOLVO (VT 2009 B * VT 2014 B * VT 2214 B * VTO 2214 B * VT 2514 B * VTO 2514 OD * VT 2814 B * VTO 2814 B)
F 15117	SKF	BT1 0097 C		ST	VOLVO (FH * NH)
F 15119	SKF FAG	BT1B 328406 A / 30314 / QVB01 568980			SCANIA (GR 801 * GR 875 * GR 900 * GRS 895 * GRS 900 * GRS 905)
F 15133	TIMKEN	NP 988748 / NP 247732			MERCEDES BENZ (G 100-12)
F 15156	FAG	804358			VOLVO (VM17 * VM23)
F 15157	FAG	543805		KP	VOLVO
F 15158	FAG	562830 A			MERCEDES BENZ (HD4 * HL4)
F 15159	FAG	575725.F51			MERCEDES BENZ (HD4 * HL4 * H04)
F 15165	FAG	548866 A			ZF (APL 345 * 35)
F 15183	FAG	Z 540669.TR1PW			MERCEDES BENZ (HD4 * HL4 * H04)
F 15184	SKF FAG	BT1B 639425 579381			SCANIA (R 560 * R 660 * RB 660 * RB 662 * RP 730 * RP 731 * RP 735 * RV 761)

01.3 \ Special design bearings Serie especial



Fersa	d (mm)	D (mm)	T (mm)
F 15190	75,000	140,000	34,250
F 15193	70,000	150,000	64,000
F 15197	35,000	72,000	24,000
F 15199	20,000	52,000	19,250
F 15200	100,000	160,000	42,000
F 15201	50,000	83,000	20,500
F 15202	35,000	89,000	38,000
F 15203	30,000	72,000	24,000
F 15208	99,975	156,975	42,000
F 15239	105,000	160,000	43,000
F 15245	60,000	130,000	33,800
F 15252	82,000	140,000	36,500
F 15253	65,000	152,000	48,000
F 15254	70,000	165,000	57,000
F 15255	60,000	150,000	51,000
F 15256	55,000	140,000	45,000
F 15257	80,000	165,000	57,000
F 15258	60,000	100,000	30,000
F 15267	100,000	160,000	44,000
F 15270	60,000	125,000	37,000

Fersa	CROSS REF.		 	
F 15190	FAG	Z 580616 TR1		 MERCEDES BENZ (G211-16 * G230-12 * G231-16 * G241-16 * G280-16 * G281-12 * G330-12)
F 15193	SKF FAG	VKHB 2280 / BT1 008 572813 4		 MERCEDES BENZ (ACTROS MP2 * MP3 * AXOR * AXOR 2)
F 15197	TIMKEN	NP 353549 / NP 673396		 LAND ROVER (Defender)
F 15199	KOYO	57355		 NISSAN (Sentra * Tsuru)
F 15200	FAG	T5ED100.576376		 DAF (1347)
F 15201	KOYO	TR 100802		 TOYOTA (Hiace * Hilux)
				 TOYOTA (Burbuja)
F 15202	KOYO	TR 070904 1		 TOYOTA (Fortune * Hiace * Hilux * Landcruiser)
F 15203	KOYO	STA 3072		 TOYOTA (Hiace * Hilux)
F 15208	SKF FAG	VKHB 2329 567549		 MERCEDES BENZ (ACTROS)
F 15239	SKF FAG	33021 / QVB 401 33021. 580938		 MAN (E 2000 * F 90 * F 2000 * M 90 * M 2000)
				 MAN (LION S COACH * LION S STAR)
F 15245	NTN	ECO CR 12A 06 1		 MERCEDES BENZ (G211-16 * G230-12 * G 231-16 * G241-16 * G280-16 * G281-12 * G330-12)
F 15252	TIMKEN SKF	NP 569484/ NP 644537 BT1-0163		 ROR (LM)
F 15253	FAG	801794 B		 MERCEDES BENZ (HL6 * HL7 * HL8)
F 15254	FAG	805015		 MERCEDES BENZ (HL6)
F 15255	FAG	805096		 MERCEDES BENZ (HD4 * HL4) MAN (HY-0925 * HY-1130)
F 15256	FAG	805097		 MERCEDES BENZ (HD4 * HL4)
F 15257	FAG	801400/801400		 MERCEDES BENZ (HL7 * HL8) MAN (HY-1344 * HY-1350 * HYD-1370)
F 15258	FAG	523361		 MERCEDES BENZ (HL2)
F 15267	FAG	805312		 MERCEDES BENZ (ACTROS MP2 * MP3)
F 15270	FAG	805050		 MERCEDES BENZ (HL2)

01.3 \ Special design bearings Serie especial



Fersa	d (mm)	D (mm)	T (mm)
F 15271	70,000	150,000	74,000
F 15272	106,000	160,000	35,000
F 15273	60,000	115,000	39,000
F 15278	42,000	92,075	24,607
F 15279	101,600	160,000	35,000
F 15280	44,983	112,712	34,512
F 15291	76,200	171,450	49,212
F 15295	53,975	95,200	34,400
F 15298	60,000	130,000	35,250
F 15304	63,500	107,950	25,400
F 15308	26,988	50,292	14,224
F 15309	30,000	62,000	20,000
F 15313	25,000	62,000	17,250
F 15314	45,000	88,000	16,750
F 15315	25,000	55,000	13,750
F 15316	25,000	66,000	22,050
F 15317	35,000	75,000	60,000
F 15322	65,000	120,000	32,750
F 15323	55,000	95,000	30,000
F 15326	85,000	150,000	38,500
F 15329	60,000	95,000	26,500
F 15332	55,000	117,000	38,000
F 15334	60,000	110,000	34,000
F 15336	25,000	55,000	13,750

Fersa	CROSS REF.				
F 15271	FAG SKF TIMKEN	801785 VKHB 2307 SET 1328			MERCEDES BENZ (ACTROS MP2 * MP3)
F 15272	FAG SKF	528595 331974			MAN (TGA * TGS) MERCEDES BENZ (ACTROS MP2 * MP3)
F 15273	FAG	581541			MERCEDES BENZ (H07) SCANIA (RB662 * RBP735 * RBP736)
F 15278	KOYO	57508 L2/28521			ZF (S5-420)
F 15279	SKF TIMKEN	BT1 0779 NP 331249			VOLVO (RS 1128 B * RSS 1332 A * RTS 2370 A * RTS 2370 B)
F 15280	FAG SKF	518713 331264			MERCEDES BENZ (HL 2)
F 15291	TIMKEN	NP725688/NP560412			VOLVO (RS 1128 B * RSS 1332 A * RTS 2370 A * RTS 2370 B)
F 15295	KOYO	LM 806649/57591N			FULLER (RTL0-16918)
F 15298	FAG	563007/801464			MERCEDES BENZ (G281-12)
F 15304	NSK	29586 A/29522			ISUZU (N-SERIES * F-SERIES)
F 15308	SKF	BT1-0227/ QVA621+L44610/QVA621			VOLKSWAGEN (DSG 6-Speeds)
F 15309	SKF	BT1-0222 A/ QVA621+32007 X/ QCL7CV/A606			VOLKSWAGEN (DSG 6-Speeds)
F 15313	TIMKEN SNR	NP417384/Y30206M EC 42226			RENAULT (PK6)
F 15314	TIMKEN FAG	NP 238750/NP 929800 571752			OPEL (M32)
F 15315	TIMKEN	NP 854792/NP 430273			OPEL (M32)
F 15316	TIMKEN SNR	NP868033/NP666556 EC42228S01			RENAULT (PF6)
F 15317	SKF	BTH-0001			IFOR WILLIAMS
F 15322	FAG	Z-504376.02			MERCEDES BENZ (HL2)
F 15323	FAG	805189			MERCEDES BENZ (ACCELO)
F 15326	FAG	F-805576.04			VOLVO (AT2412C * AT2512C)
F 15329	KOYO	32012 J/IB			VOLKSWAGEN (CRAFTER)
F 15332	NTN	33212.1/ECO CR-1187.1			MERCEDES BENZ (G211-12)
F 15334	NTN	ECO CR-12A17.1			MERCEDES BENZ (G211-12)
F 15336	SNR	EC 42192 Y S02 H206			FIAT * GM (M20 * M32)

01.3 \ Special design bearings Serie especial



Fersa	d (mm)	D (mm)	T (mm)
F 15337	25,000	52,000	16,300
F 15338	28,000	55,000	13,750
F 15339	25,000	51,400	13,200
F 15340	41,000	73,000	21,000
F 15341	95,000	126,000	18,100
F 15342	27,000	51,400	13,200
F 15345	85,000	150,000	30,500
F 15346	60,000	115,000	40,000
F 15347	60,000	110,000	29,750
F 15348	60,000	110,000	38,000
N F 15361	70,000	165,000	57,000
N F 15366	68,000	140,000	49,000
N F 15367	68,000	152,000	47,000
N F 15376	53,000	82,000	14,000
N F 15377	60,000	89,000	15,000
N F 15381	35,000	65,000	35,000
N F 15382	45,000	88,000	17,000
N F 15383	45,000	82,000	23,000
N F 15384	34,000	73,000	23,000
N F 15385	120,000	181,000	48,000
N F 15386	60,000	125,000	37,000
N F 15388	114,000	177,000	41,000























Fersa	CROSS REF.				
F 15337	SNR	EC 42224 S01 H206			RENAULT (PK4 * PK5)
F 15338	SNR	EC 42193 Y S02 H206			FIAT * GM (M20 * M32)
F 15339	SNR	EC 42310 S01 H200			FIAT * GM (M20 * M32)
F 15340	SNR	EC 42217 S01 H206			FIAT * GM (M32)
F 15341	SNR	EC 12606 S01 H106			RENAULT (AD8 * PF1 * PK1 * PK5 * PK6 * PK9)
F 15342	TIMKEN	NP030522/NP378917			FIAT * GM (M32)
F 15345	SKF	VKT 9000 30217J2/QVB478/ BT1-1010			VOLVO (VT1708B * VT2009B * VT2214B * VT2412B * VT2514B * VTO2214 * AT2512C * AT2812C * ATO3112C)
F 15346	FAG	558841.04.LTR1			VOLVO (VT1708B * VT2009B * VT2214B * VT2412B * VT2514B * VTO2214 * AT2512C * AT2812C * ATO3112C)
F 15347	FAG	F-580794.TR1			VOLVO (VT1708B * VT2009B * VT2214B * VT2412B * VT2514B * VTO2214 * AT2512C * AT2812C * ATO3112C)
F 15348	FAG	F-580791.TR1			VOLVO (VT1708B * VT2009B * VT2214B * VT2412B * VT2514B * VTO2214 * AT2512C * AT2812C * ATO3112C * R1400 * SR1400 * SR1700 * SR1900)
N F 15361	FAG	546439			DAF (1347 * 1339) MAN (HY-1175 * HY-1350 (Ø425 mm))
N F 15366	TIMKEN	NP802577/NP896994			MERITOR (MS17X)
N F 15367	TIMKEN	NP003658/NP096839			MERITOR (MS17X)
N F 15376	TIMKEN	NP925485/NP312842			MERCEDES BENZ (Transfer case)
N F 15377	TIMKEN	NP604623/NP577617			MERCEDES BENZ (Transfer case)
N F 15381	SNR	FC 12033			RENAULT (Clio I * II * Express * Thalia * Twingo * Super 5 * Renault 9 * 11 * 19)
N F 15382	FAG	F-571752.03.TR1-DY-H73			GM (M30 * M32)
N F 15383	TIMKEN	SET 702			FORD (2009-2007 F450 Super Duty * F550 Super Duty * Twin I-Beam)
N F 15384	TIMKEN	SET 703			FORD (2009-2007 F450 Super Duty * F550 Super Duty * Twin I-Beam)
N F 15385	FAG	33024/588641			DANA (D170 * D190)
N F 15386	FAG	576791.H131AB			DAF (1132 * 11325 * 1332)
N F 15388	FAG	F-585057.02			DANA (D170)

01.4 \ Flange side bearings Rodamientos con valona



Fersa	d (mm)	D (mm)	T (mm)
11163/11300 B	41,275	76,200	7,292
30208 BF	40,000	80,000	7,750
30210 BF	50,000	90,000	8,750
33113 B	65,000	110,000	13,000
34300/34478 B	76,200	121,442	11,907
45285 A/45220 B	50,800	110,230	30,160
65237/65500 B	60,325	127,000	16,670
F 15090	25,000	59,000	4,100
F 15108	21,986	45,000	6,500
F 15161	45,000	110,000	12,000
F 15191	80,000	139,992	14,288
F 15192	60,000	130,000	12,250
F 15196	25,000	54,000	9,250
F 15198	31,750	62,000	7,938
F 15212	50,800	104,775	12,000
F 15246	80,000	130,000	5,500
F 15265	65,000	140,000	13,500
F 15310	40,000	68,000	8,000
F 15311	30,000	55,500	7,000
F 15312	27,000	62,000	6,700
HM 807046/HM 807010 BT	50,800	104,775	12,000
JHM 803148/JHM 803113 B	45,000	90,000	9,000
LM 67048/LM 67010 BA	31,750	58,877	6,833
LM 67048/LM 67010 BCE	31,750	59,131	6,375
M 88043/M 88010 B	30,162	68,262	8,730



Fersa	CROSS REF.				
11163/11300 B					
30208 BF					
30210 BF					
33113 B					
34300/34478 B					
45285 A/45220 B					ZF
65237/65500 B					
F 15090	SNR	EC 12567 H206			RENAULT (JC5)
F 15108	TIMKEN	XC 06536 CD / JXC 06536 DC			
F 15161	TIMKEN	JXC 25690 C / JXC 25690 DC			MERCEDES BENZ (G04/160 * G0170-6 * G0190-6 * G0210-6 * G0230-6 * G0240-6)
F 15191	FAG	568742 A			ZF (165 181 * 165 182 * 165 200 A * 165 251 * 165 252)
F 15192	FAG	805046 / 801464			MERCEDES BENZ (G211 16 * G221 9 * G241 16 * G330)
F 15196	NTN	ETA CR 05A225TPX1			RENAULT
F 15198	TIMKEN	NP 390444 / NP 750997			LAND ROVER (Defender * Discovery * Range Rover)
F 15212	NTN	4T 45285 APX1/4T CR 1091 PX1			ZF (65-150C * 95-109 * 165-109)
F 15246	FAG	575194			ZF (165-151)
F 15265	TIMKEN	NP 881387 / NP 304907			MERCEDES BENZ (G04/160 * G0170-6 * G0190-6 * G0210-6 * G0230-6 * G0240-6)
F 15310	SKF	32008 X/ QVA621+BT1-0336/ QCL7CVA606			VOLKSWAGEN (DSG 6-Speeds)
F 15311	TIMKEN	NP765903 / NP919474			VOLKSWAGEN (VAG)
F 15312	TIMKEN	NP 806712 / NP 326808			SAAB (5 Speeds)
HM 807046/ HM 807010 BT JHM 803148/ JHM 803113 B LM 67048/ LM 67010 BA LM 67048/ LM 67010 BCE					
M 88043 / M 88010 B					



01.5 U type bearings

Rodamientos tipo U



Fersa	d (mm)	D (mm)	B (mm)	C (mm)	C1 (mm)	T (mm)
U 298/U 261 L	34,987	64,975	20,600	14,000	17,000	18,100
U 298/U 261 L + COLLAR	34,987	64,975	20,600	14,000	17,000	18,100
U 399/U 360 L	39,688	73,025	22,098	15,265	18,500	19,395
U 399/U 360 L + COLLAR	39,688	73,025	22,098	15,265	18,500	19,395
U 399/U 365 L	39,688	79,967	22,098	15,265	20,091	19,395
U 399/U 365 L + COLLAR	39,688	79,967	22,098	15,265	20,091	19,395
U 497/U 460 L	44,987	79,975	26,000	18,400	22,000	24,000
U 497/U 460 L + COLLAR	44,987	79,975	26,000	18,400	22,000	24,000



A series of horizontal dotted lines for writing notes or comments.

01.6 \ Steering bearings

Rodamientos de dirección



Fersa	d1 (mm)	D (mm)	C (mm)	β
5 BC	28,313	-	-	25° 24'
6	-	44,450	9,525	-
6 CE	-	49,146	19,050	-
11 BC	33,297	-	-	29° 58'
13 C	-	49,225	11,509	-
14 XS	-	57,092	17,094	-
35 BC	43,655	-	-	31° 52'



A series of horizontal dotted lines for writing notes.



A series of horizontal dotted lines spanning the width of the page, intended for writing or drawing.

01.7 \ Interior Sets

Conjuntos interiores



Fersa	d (mm)	B (mm)
CONE 4367 X	39,688	40,386
CONE 4395	42,070	40,386
CONE 33113 F	65,000	34,000
CONE 64452 A	114,970	41,270
CONE F 15084	24,000	28,500
CONE F 15101	28,000	32,000
CONE F 15110	32,000	29,500
CONE F 15111	55,000	29,800
CONE F 15113	50,000	41,275
CONE F 15131	38,100	29,771
CONE F 15132	45,000	30,045
CONE F 15134	65,000	31,000
CONE F 15150 A	40,000	38,000
CONE F 15213	32,000	33,000
CONE F 15244	50,000	41,000
CONE F 15249	39,688	40,386
CONE F 15269	55,000	29,800
CONE F 15292	39,688	43,050
CONE F 15327	68,260	44,250
CONE F 15328	69,850	51,750
CONE F 15333	52,000	24,000
CONE F 15356	40,000	35,000

Fersa	CROSS REF.			
CONE 4367 X				 MERCEDES BENZ (G210 -16 * G211-12 * G221-9 * G240-16 * G260-16)
CONE 4395				 ZF (165-151 * 165-181 * 165-221 * 85-180)
CONE 33113 F				 VOLVO (AT 2412 C * VT 2014 B * VT 2514 B)
CONE 64452 A				 DANA (R170/R190)
CONE F 15084	KOYO	ST 2455		 ZF (S5-420)
CONE F 15101	TIMKEN	JXC 6839 CD		 ZF (S6-85)
CONE F 15110	TIMKEN	JXC 25662 C		 ZF (95-109 * 65-150 C) MERCEDES BENZ (G100-12)
CONE F 15111	KOYO	ST 4276 C/A		 MERCEDES BENZ (G240-16 * G241-16 * G260-16 * G280-16)
CONE F 15113	NTN	ETA CIR 1010 1		 MERCEDES BENZ (G240-16 * G241-16 * G260-16 * G280-16 * G281-12 * G330-12)
CONE F 15131	TIMKEN	NP 457202		 MERCEDES BENZ (G100-12)
CONE F 15132	TIMKEN	NP 057427		 MERCEDES BENZ (G100-12)
CONE F 15134	TIMKEN	JXC 19089 DA		 MERCEDES BENZ (G100-12)
CONE F 15150 A	FAG	576503		 VOLVO (AT 2412 C * VT 2014 B * VT 2514 B)
CONE F 15213	SKF	BT1B 329154/Q/CL7C		 ZF (85-109 * 165-109)
CONE F 15244	NTN	ETA CIR 1006.1		 MERCEDES BENZ (G210 16 * G211 16 * G230 16 * G 231 16)
CONE F 15249	NTN	ECO CIR 0805.2		 MERCEDES BENZ (G211-16 * G230-12 * G 231-16 * G241-16 * G280-16 * G281-12 * G330-12)
CONE F 15269	NTN	ETA CIR-1106		 MERCEDES BENZ (G281-16 * G330-12)
CONE F 15292	NTN	ETA CIR-0810.1		 MERCEDES BENZ (G221-9* G0240-6)
CONE F 15327	TIMKEN	NP 927527		 DANA (R170/R190)
CONE F 15328	TIMKEN	NP 478770		 DANA (R170/R190)
CONE F 15333	NTN	ETA CIR 1012		 MERCEDES BENZ (G211-12)
CONE F 15356	SKF	BT1-0445		 SCANIA (GR 905)

Double row tapered roller bearings

Rodamientos de rodillos cónicos de doble hilera

02.1 \	Special double row tapered roller bearings / Rodamientos de rodillos cónicos de doble hilera especiales	52
02.2 \	Pinion module / Módulo de Piñón	56

02

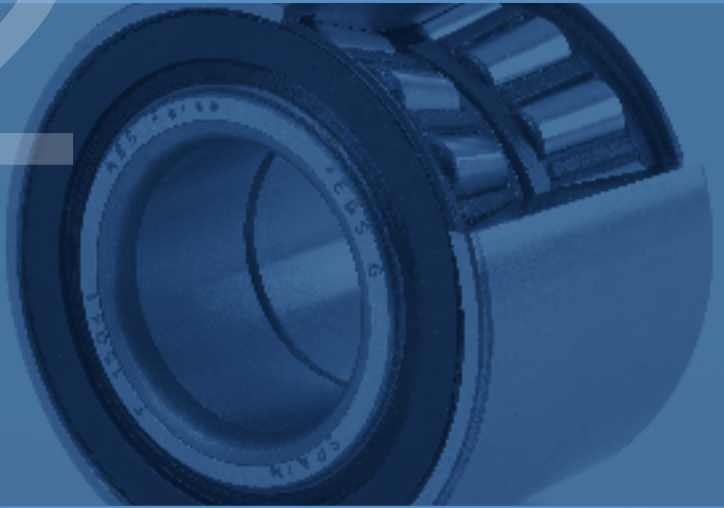

02.1 \ Special double row tapered roller bearings

Rodamientos de rodillos cónicos de doble hilera especiales

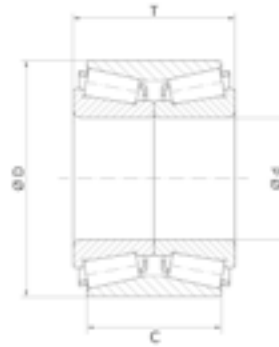
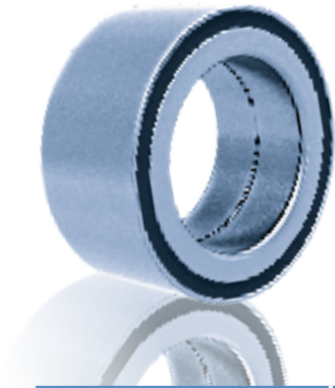

Fersa	d (mm)	D (mm)	C / T (mm)	TYPE
F 15015	41,000	68,000	35,000 / 40,000	A
F 15041	25,000	52,000	37,000	A
F 15042	25,000	52,000	43,000	A
F 15043	25,000	55,000	43,000	A
F 15044	35,000	65,000	35,000	A
F 15045	39,000	68,000	37,000	A
F 15050	25,000	52,000	37,000	A
F 15067	29,000	53,000	37,000	A
F 15068	49,000	84,000	48,000	A
F 15128	27,000	53,000	43,000	A
F 15129	40,000	75,000	50,000	A
F 15130	42,000	80,000	38,000	A
F 15146	54,000	142,000	62,000	B
F 15149	40,000	80,000	38,000	A
F 15151	27,000	52,000	45,000 / 50,000	A
F 15154	45,000	115,000	53,000	B
F 15160	43,000	77,000	41,500 / 45,500	A

Type / Tipo

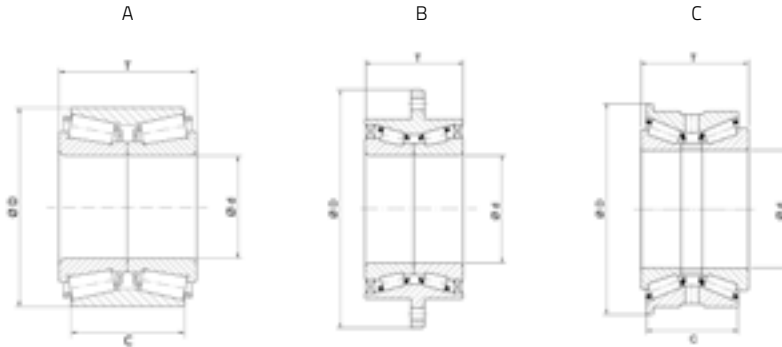





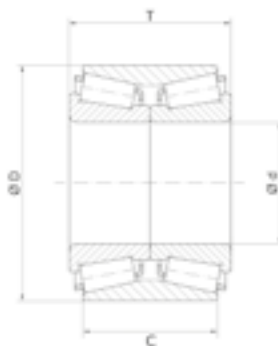
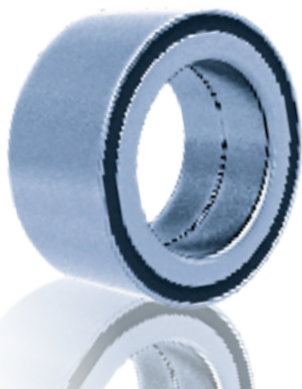

Fersa	CROSS REF.				
F 15015	NSK	41KWD01G3			SUZUKI (Grand Vitara * Vitara * X 90)
F 15041	SKF FAG SNR	BT2B445539BA / VC025 546467 FC 12025 S09			CITROËN (AX * C2 * C3 * Saxo * Visa * Xsara * ZX) DACIA (Logan) NISSAN (Aprio * Micra * Note * Platina) PEUGEOT (106 * 205 * 206 * 306 * 309 * 1007) RENAULT (Super 5 * 9 * 11 * 19) Clio * Megane * Modus * Tahlia * Twingo * Chamade)
F 15042	SNR	FC 12180 S04			RENAULT (Extra * Express * 21 * Rapid)
F 15043	SNR	FC 12271 S03			MERCEDES BENZ (Clase A) NISSAN (Kubistar) RENAULT (Kangoo * Laguna * Express)
F 15044	FAG TIMKEN SNR	546238 JRM 3535 A / JRM 3565 XD FC 12033S01			RENAULT (Clio * Express * Tahlia * Twingo * Super 5 * 9 * 11 * 19)
F 15045	TIMKEN	JRM 3939 / JRM 3968 XD			AUDI (80 * 90 * Coupe) VOLKSWAGEN (Golf * Jetta * Passat * Santana)
F 15050	SNR	FC 12784 S03			RENAULT (Clio * Megane * Super 5 * 9 * 11 * 19)
F 15067	SKF NATIONAL	BTH 1206 AB 516007			FORD (Ecostport * Fiesta * Focus * Fusion) MAZDA (2)
F 15068	TIMKEN	JXC 25469CA / JXC 25469 DB			FORD (Transit)
F 15128	KOYO SNR	DAC 2753 FC 40650 S01			CHEVROLET (Corsa) OPEL (Corsa * Tigra)
F 15129	NSK	40KWD02			MITSUBISHI (L200) NISSAN (Urvan)
F 15130	NSK NATIONAL	42KWD08A 516005			NISSAN (Frontier * Infiniti * Pathfinder * Urvan * Xterra)
F 15146	NSK	54KWH02			TOYOTA (Hiace)
F 15149	NTN	DAC 4T CR1			
F 15151					NISSAN (Tsuru III)
F 15154	SKF	BTF 1125 B			FORD (Transit)
F 15160	NSK	43 KWD 07AU42CA			TOYOTA (Hilux)

02.1 \ Special double row tapered roller bearings Rodamientos de rodillos cónicos de doble hilera especiales



Fersa	d (mm)	D (mm)	C / T (mm)	TYPE
F 15168	49,000	84,000	48,000	A
F 15173	35,000	68,000	48,000	A
F 15174	45,300	80,000	48,000	A
F 15175	25,000	55,000	45,000	A
F 15187	40,000	73,000	55,000	A
F 15218	42,000	82,000	40,000	A
F 15268	47,000	88,000	55,000	A
F 15302	55,000	90,000	55,000	A
F 15317	55,000	75,000	60,000	A
F 15324	54,000	158,000	51,000	B
 F 15330	69,850	126,000	54,626 / 63,880	C
 F 15360	30,000	62,000	48,000	A
 N F 15380	69,000	116,000	58,275 / 71,880	C



Fersa	CROSS REF.				
F 15321	TIMKEN	SET 1265			IVECO (U 177) VOLVO (RSS1228B * RS1344B)
 F 15371	TIMKEN	XC25378FK			VOLVO (RTS2370A (rear) * RTS 2370B (rear))



Area with horizontal dotted lines for additional entries.

03

Thrust tapered roller bearings

Rodamientos axiales cónicos

03

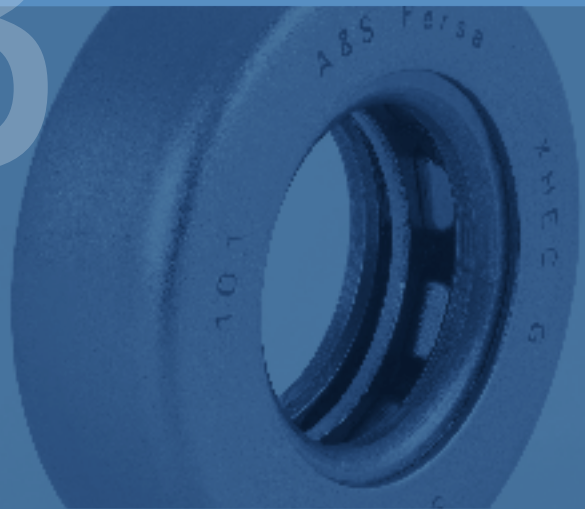

Type / Tipo

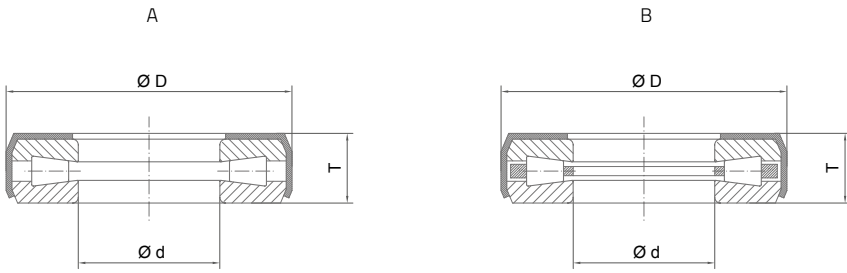

A series of horizontal dotted lines for writing, spanning the width of the page.

Deep groove ball bearings

Rodamientos radiales de bolas

04.1 \	Standard ball bearings / Rodamientos de bolas estándar	64
04.2 \	Special ball bearings / Rodamientos de bolas especiales	76

04

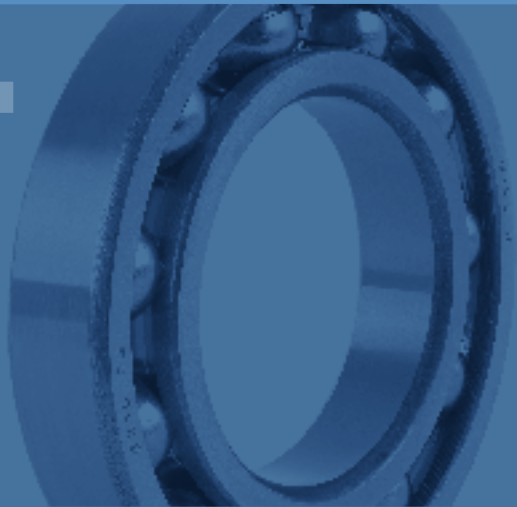

04.1 \ Standard ball bearings Rodamientos de bolas estándar

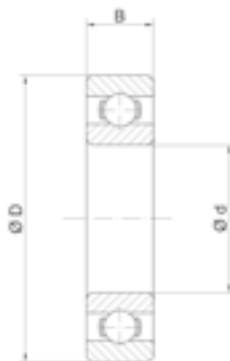

Serie	Fersa	d (mm)	D (mm)	B (mm)
600 SERIE				
607	607 2RS/C3 607 ZZ/C3	7,000	19,000	6,000
608	608 2RS/C3 608 ZZ/C3	8,000	22,000	7,000
609	609 2RS/C3 609 ZZ/C3	9,000	24,000	7,000

620 SERIE				
626	626 2RS/C3 626 ZZ/C3	6,000	19,000	6,000
628	628 2RS/C3 628 ZZ/C3	8,000	24,000	8,000
629	629 2RS/C3 629 ZZ/C3	9,000	26,000	8,000

6000 SERIE				
6000	6000 6000 2RS 6000 2RS/C3 6000 Z 6000 ZZ 6000 ZZ/C3	10,000	26,000	8,000
6001	6001 6001 2RS 6001 2RS/C3 6001 Z 6001 ZZ 6001 ZZ/C3	12,000	28,000	8,000
6002	6002 6002 2RS 6002 2RS/C3 6002 Z 6002 ZZ 6002 ZZ/C3	15,000	32,000	9,000
6003	6003 6003 2RS 6003 2RS/C3 6003 Z 6003 ZZ 6003 ZZ/C3	17,000	35,000	10,000

Suffixes / Sufijos

- C3** Internal clearance greater than normal / Juego radial mayor que el normal
- C4** Internal clearance greater than C3 / Juego radial mayor que C3
- RS** Rubbing seal at one side / Tapa retén en una cara
- 2RS** Rubbing seals at both sides / Tapa retén en las dos caras
- Z** Shield at one side / Tapa en una cara
- ZZ** Shields at both sides / Tapas en las dos caras
- NR** Snap ring groove and snap ring / Ranura y anillo elástico en aro exterior

04

Serie	Fersa	d (mm)	D (mm)	B (mm)
6004	6004	20,000	42,000	12,000
	6004 C3			
	6004 RS			
	6004 2RS			
	6004 2RS/C3			
	6004 Z			
	6004 ZZ			
6004 ZZ/C3				
6005	6005	25,000	47,000	12,000
	6005 2RS			
	6005 2RS/C3			
	6005 Z			
	6005 ZZ			
6005 ZZ/C3				
6006	6006	30,000	55,000	13,000
	6006 2RS			
	6006 2RS/C3			
	6006 Z			
	6006 ZZ			
6006 ZZ/C3				
6006/32	6006/32 2RS/C3	32,000	55,000	13,000
6007	6007	35,000	62,000	14,000
	6007 2RS			
	6007 2RS/C3			
	6007 Z			
	6007 ZZ			
6007 ZZ/C3				
6008	6008	40,000	68,000	15,000
	6008 2RS			
	6008 2RS/C3			
	6008 Z			
	6008 ZZ			
	6008 ZZ NR			
6008 ZZ/C3				
6009	6009	45,000	75,000	16,000
	6009 NR			
	6009 2RS			
	6009 2RS/C3			
	6009 Z			
	6009 ZZ			
	6009 ZZ/C3			
6009 ZZ NR				

04.1 \ Standard ball bearings Rodamientos de bolas estándar

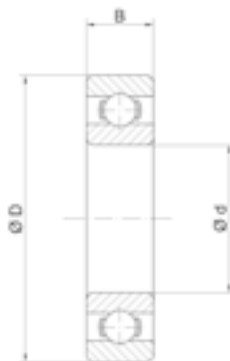

Serie	Fersa	d (mm)	D (mm)	B (mm)
6000 SERIE				
6010	6010 6010 2RS 6010 2RS/C3 6010 Z 6010 ZZ 6010 ZZ/C3	50,000	80,000	16,000
6011	6011 6011 2RS 6011 2RS/C3 6011 Z 6011 ZZ 6011 ZZ/C3	55,000	90,000	18,000
6012	6012 6012 2RS 6012 2RS/C3 6012 Z 6012 ZZ 6012 ZZ/C3	60,000	95,000	18,000
6013	6013 6013 C3 6013 2RS 6013 2RS/C3 6013 Z 6013 ZZ 6013 ZZ/C3	65,000	100,000	18,000
6014	6014 6014 2RS 6014 2RS/C3 6014 Z 6014 ZZ 6014 ZZ/C3 6014 C3	70,000	110,000	20,000
6015	6015 6015 2RS 6015 2RS/C3 6015 Z 6015 ZZ 6015 ZZ/C3	75,000	115,000	20,000
6016	6016 2RS/C3	80,000	125,000	22,000
6017	6017 NR	85,000	130,000	22,000
61900 SERIE				
61904	61904 2RS	20,000	37,000	9,000
61909	61909 2RS	45,000	68,000	12,000
61915	61915 C3	75,000	105,000	16,000

Suffixes / Sufijos

- C3** Internal clearance greater than normal / Juego radial mayor que el normal
- C4** Internal clearance greater than C3 / Juego radial mayor que C3
- RS** Rubbing seal at one side / Tapa retén en una cara
- 2RS** Rubbing seals at both sides / Tapa retén en las dos caras
- Z** Shield at one side / Tapa en una cara
- ZZ** Shields at both sides / Tapas en las dos caras
- NR** Snap ring groove and snap ring / Ranura y anillo elástico en aro exterior

Serie	Fersa	d (mm)	D (mm)	B (mm)
6200 SERIE				
62/22	62/22 2RS/C3	22,000	50,000	14,000
6200	6200 6200 2RS 6200 2RS/C3 6200 Z 6200 ZZ 6200 ZZ/C3	10,000	30,000	9,000
6201	6201 6201 2RS 6201 2RS/C3 6201 Z 6201 ZZ 6201 ZZ/C3	12,000	32,000	10,000
6202	6202 6202 2RS 6202 2RS/C3 6202 Z 6202 ZZ/C3 6202 ZZ NR	15,000	35,000	11,000
6203	6203 6203 2RS 6203 2RS/C3 6203 Z 6203 ZZ 6203 ZZ/C3	17,000	40,000	12,000
6203/12	6203/12 2RS	12,000	40,000	12,000
6204	6204 6204 2RS 6204 2RS/C3 6204 Z 6204 ZZ/C3 6204 ZZ NR	20,000	47,000	14,000
6205	6205 6205 2RS 6205 2RS NR 6205 2RS/C3 6205 Z 6205 ZZ 6205 ZZ/C3 6205 ZZ NR	25,000	52,000	15,000
6205 B12 D56	6205 B12 D56	25,000	56,000	12,000

04.1 \ Standard ball bearings

Rodamientos de bolas estándar

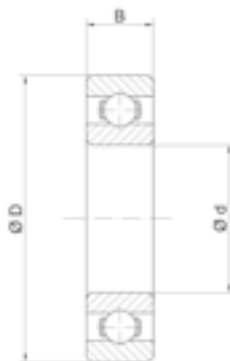

Serie	Fersa	d (mm)	D (mm)	B (mm)
6200 SERIE				
6206	6206 6206 2RS 6206 2RS/C3 6206 Z 6206 ZZ 6206 ZZ/C3 6206 ZZ NR	30,000	62,000	16,000
6207	6207 6207 C3 6207 2RS 6207 2RS/C3 6207 Z 6207 Z NR 6207 ZZ 6207 ZZ/C3	35,000	72,000	17,000
6207/33	6207/33	33,000	72,000	17,000
6208	6208 6208 2RS 6208 2RS/C3 6208 Z 6208 ZZ 6208 ZZ/C3 6208 NR	40,000	80,000	18,000
6209	6209 6209 C3 6209 2RS 6209 2RS/C3 6209 Z 6209 ZZ 6209 ZZ/C3 6209 ZZ NR	45,000	85,000	19,000
6210	6210 6210 C3 6210 2RS 6210 2RS/C3 6210 Z 6210 ZZ 6210 Z NR 6210 ZZ NR 6210 ZZ/C3	50,000	90,000	20,000
6211	6211 6211 2RS 6211 2RS/C3 6211 Z 6211 ZZ 6211 ZZ/C3 6211 ZNR 6211 C3	55,000	100,000	21,000

Suffixes / Sufijos

- C3** Internal clearance greater than normal / Juego radial mayor que el normal
- C4** Internal clearance greater than C3 / Juego radial mayor que C3
- RS** Rubbing seal at one side / Tapa retén en una cara
- 2RS** Rubbing seals at both sides / Tapa retén en las dos caras
- Z** Shield at one side / Tapa en una cara
- ZZ** Shields at both sides / Tapas en las dos caras
- NR** Snap ring groove and snap ring / Ranura y anillo elástico en aro exterior

Serie	Fersa	d (mm)	D (mm)	B (mm)
6212	6212	60,000	110,000	22,000
	6212 2RS			
	6212 2RS/C3			
	6212 2RS NR			
	6212 Z			
	6212 ZNR/C3			
	6212 ZZ			
6212 ZZ/C3				
6213	6213	65,000	120,000	23,000
	6213 C3			
	6213 2RS			
	6213 2RS/C3			
	6213 2RS NR/C3			
	6213 NR			
	6213 Z			
	6213 ZMNR/C3			
	6213 ZZ			
6213 ZZ/C3				
6214	6214	70,000	125,000	24,000
	6214 2RS			
	6214 2RS/C3			
	6214 Z			
	6214 ZZ			
	6214 ZZ/C3			
6215	6215	75,000	130,000	25,000
	6215 2RS			
	6215 2RS/C3			
	6215 NR/C3			
	6215 NR/C3			
	6215 Z			
	6215 ZZ			
	6215 ZZ/C3			
6216	6216	80,000	140,000	26,000
	6216 C3			
	6216 2RS			
	6216 2RS/C3			
	6216 NR/C3			
	6216 C3			
	6216 C4			
	6216 Z			
	6216 ZZ			
	6216 ZZ/C3			
6217	6217	85,000	150,000	28,000
	6217 C3			
6217/80	6217/80 C3	80,000	150,000	28,000
6218	6218	90,000	160,000	30,000
	6218 C3			

04.1 \ Standard ball bearings Rodamientos de bolas estándar

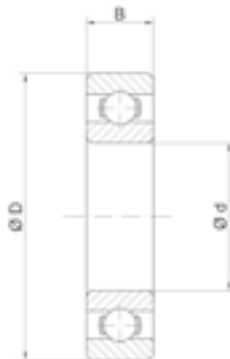

Serie	Fersa	d (mm)	D (mm)	B (mm)
62200 SERIE				
62201	62201 2RS/C3	12,000	32,000	14,000
62202	62202 2RS/C3	15,000	35,000	14,000
62204	62204 2RS	20,000	47,000	18,000
62205	62205 2RS	25,000	52,000	18,000
62206	62206 2RS	30,000	62,000	20,000
62207	62207 2RS	35,000	72,000	23,000
62208	62208 2RS	40,000	80,000	23,000
62212	62212 2RS	60,000	110,000	28,000

62300 SERIE				
62304	62304 2RS/C3	20,000	52,000	21,000
62305	62305 62305 C3 62305 2RS/C3	25,000	62,000	24,000
62306	62306 2RS/C3	30,000	72,000	27,000

63 / SERIE				
63/22	63/22	22,000	56,000	16,000
63/28	63/28 63/28 2RS/C3	28,000	68,000	18,000
63/32	63/32 2RS 63/32 NR/C3	32,000	75,000	20,000

6300 SERIE				
6300	6300 6300 2RS 6300 2RS/C3 6300 Z 6300 ZZ 6300 ZZ/C3	10,000	35,000	11,000
6301	6301 6301 2RS 6301 2RS/C3 6301 Z 6301 ZZ 6301 ZZ/C3	12,000	37,000	12,000
6302	6302 6302 2RS 6302 2RS/C3 6302 Z 6302 ZZ 6302 ZZ/C3	15,000	42,000	13,000

Suffixes / Sufijos

- C3** Internal clearance greater than normal / Juego radial mayor que el normal
- C4** Internal clearance greater than C3 / Juego radial mayor que C3
- RS** Rubbing seal at one side / Tapa retén en una cara
- 2RS** Rubbing seals at both sides / Tapa retén en las dos caras
- Z** Shield at one side / Tapa en una cara
- ZZ** Shields at both sides / Tapas en las dos caras
- NR** Snap ring groove and snap ring / Ranura y anillo elástico en aro exterior

Serie	Fersa	d (mm)	D (mm)	B (mm)
6303	6303	17,000	47,000	14,000
	6303 2RS			
	6303 2RS/C3			
	6303 Z			
	6303 ZZ			
	6303 ZZ/C3			
6303/15	6303/15 2RS	15,000	47,000	14,000
6304	6304	20,000	52,000	15,000
	6304 2RS			
	6304 2RS/C3			
	6304 Z			
	6304 ZZ			
	6304 ZZ/C3			
6304 B12	6304 B12	20,000	52,000	12,000
6304 B12 D56	6304 B12 D56	20,000	56,000	12,000
6304/17	6304/17 2RS	17,000	52,000	15,000
6304/17 B16	6304/17 B16 2RS	17,000	52,000	16,000
6304/17 B17	6304/17 B17 2RS	17,000	52,000	17,000
6305	6305	25,000	62,000	17,000
	6305 2RS			
	6305 2RS NR			
	6305 2RS/C3			
	6305 Z			
	6305 ZZ			
	6305 ZZ/C3			
6306	6306	30,000	72,000	19,000
	6306 2RS			
	6306 2RS NR			
	6306 2RS/C3			
	6306 NR/C3			
	6306 Z			
	6306 ZZ			
6306 ZZ NR				
6306 ZZ/C3				
6306/25	6306/25 2RS/C3	25,000	72,000	19,000
6307	6307	35,000	80,000	21,000
	6307 2RS			
	6307 2RS NR			
	6307 2RS C3			
	6307 Z			
	6307 ZZ			
6307 ZZ/C3				
6307 B23	6307 B23	35,000	80,000	23,000
	6307 B23 NR			

04.1 \ Standard ball bearings Rodamientos de bolas estándar

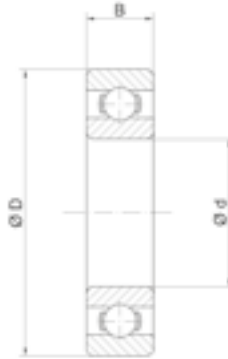

Serie	Fersa	d (mm)	D (mm)	B (mm)
6300 SERIE				
6308	6308 6308 2RS 6308 2RS/C3 6308 NR 6308 Z 6308 ZZ 6308 ZZ/C3	40,000	90,000	23,000
6309	6309 6309 2RS 6309 2RS/C3 6309 Z 6309 ZZ 6309 ZZ/C3	45,000	100,000	25,000
6310	6310 6310 2RS 6310 2RS/C3 6310 NR/C3 6310 Z 6310 ZZ 6310 ZZ/C3	50,000	110,000	27,000
6311	6311 6311 C3 6311 2RS 6311 2RS/C3 6311 NR 6311 Z 6311 ZZ 6311 ZZ/C3	55,000	120,000	29,000
6312	6312 6312 2RS 6312 2RS/C3 6312 2RS NR 6312 NR/C3 6312 Z 6312 ZZ 6312 ZZ/C3	60,000	130,000	31,000
6313	6313 6313 2RS 6313 2RS/C3 6313 C3 6313 C4 6313 Z 6313 ZZ 6313 ZZ/C3	65,000	140,000	33,000

Suffixes / Sufijos

- C3** Internal clearance greater than normal / Juego radial mayor que el normal
- C4** Internal clearance greater than C3 / Juego radial mayor que C3
- RS** Rubbing seal at one side / Tapa retén en una cara
- 2RS** Rubbing seals at both sides / Tapa retén en las dos caras
- Z** Shield at one side / Tapa en una cara
- ZZ** Shields at both sides / Tapas en las dos caras
- NR** Snap ring groove and snap ring / Ranura y anillo elástico en aro exterior

Serie	Fersa	d (mm)	D (mm)	B (mm)
6314	6314	70,000	150,000	35,000
	6314 2RS			
	6314 2RS/C3			
	6314 NR/C3			
	6314 Z			
	6314 ZZ			
6315	6315	75,000	160,000	37,000
	6315 2RS			
	6315 2RS/C3			
	6315 Z			
	6315 ZZ			
	6315 ZZ/C3			

63010 SERIE

63010	63010 2RS	50,000	80,000	23,000
--------------	-----------	--------	--------	--------

6400 SERIE

6403	6403	17,000	62,000	17,000
	6403 C3			
	6403 2RS			
	6403 2RS/C3			
	6403 Z			
	6403 ZZ			
6404	6404	20,000	72,000	19,000
	6404 2RS			
	6404 2RS/C3			
	6404 Z			
	6404 ZZ			
	6404 ZZ/C3			
6405	6405	25,000	80,000	21,000
	6405 2RS			
	6405 2RS/C3			
	6405 Z			
	6405 ZZ			
	6405 ZZ/C3			
6406	6406	30,000	90,000	23,000
	6406 2RS			
	6406 2RS/C3			
	6406 Z			
	6406 ZZ			
	6406 ZZ/C3			

04.1 \ Standard ball bearings

Rodamientos de bolas estándar

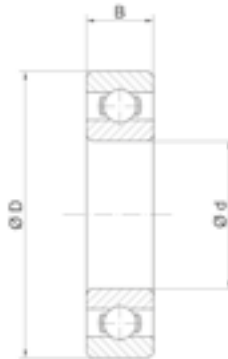

Serie	Fersa	d (mm)	D (mm)	B (mm)
6400 SERIE				
6407	6407 6407 2RS 6407 2RS/C3 6407 Z 6407 ZZ 6407 ZZ/C3	35,000	100,000	25,000
6408	6408 6408 2RS 6408 2RS/C3 6408 Z 6408 ZZ 6408 ZZ/C3	40,000	110,000	27,000
6409	6409 6409 2RS 6409 2RS/C3 6409 Z 6409 ZZ 6409 ZZ/C3	45,000	120,000	29,000
6410	6410 6410 2RS 6410 2RS/C3 6410 Z 6410 ZZ 6410 ZZ/C3	50,000	130,000	31,000
6411	6411 6411 2RS 6411 2RS/C3 6411 Z 6411 ZZ 6411 ZZ/C3	55,000	140,000	33,000
6412	6412 6412 2RS 6412 2RS/C3 6412 Z 6412 ZZ 6412 ZZ/C3	60,000	150,000	35,000
6413	6413 6413 2RS 6413 2RS/C3 6413 Z 6413 ZZ 6413 ZZ/C3	65,000	160,000	37,000

04.2 \ Special ball bearings Rodamientos de bolas especiales

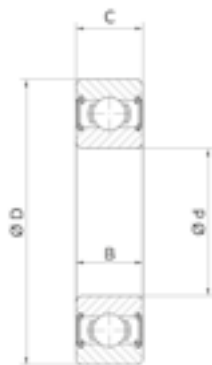







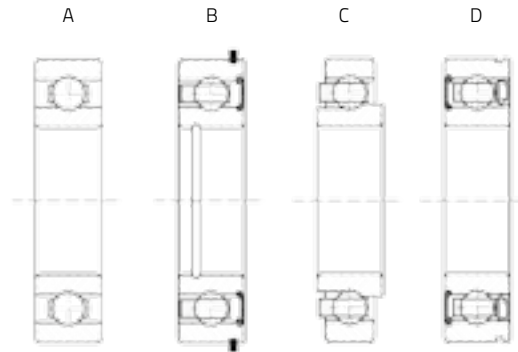













Fersa	d (mm)	D (mm)	C / B (mm)	TYPE
F 18009	45,000	85,000	23,000	ESP
F 18011	30,000	65,000	21,000	A
F 18015	15,000	35,000	13,000	A
F 18018	25,000	62,020	17,500	B
F 18019	25,000	59,000	17,500	B
F 18020	17,000	62,000	17,600 / 17,000	A
F 18021	28,000	66,000	18,000	B
F 18022	25,000	69,000	20,000	A
F 18023	35,000	75,000	20,000	B
F 18024	25,995	68,000	14,500 / 21,550	C
F 18032	50,000	90,000	20,000	A
F 18033	50,000	90,000	20,000	A
F 18036	85,000	150,000	28,000	B
F 18037	85,000	160,000	33,000	B
F 18038	36,487	68,000	15,000	A
F 18039	36,513	68,000	15,000	B
F 18041	50,000	90,000	20,000	A
F 18042	55,000	120,000	29,000	A
F 18043	28,000	75,000	21,000	D
F 18046 2RS	12,000	32,000	10,000 / 15,350	ESP

*ESP For more special drawing details, contact with Fersa / Para más información técnica, contactar con Fersa.

Type / Tipo



04

Fersa	CROSS REF.			
F 18009	FAG 4209 BT VH SKF 4209 ATN9 / MT33 VB2669 SNR 4209 A IRB IR 8566			
F 18011	FAG 543909 SKF BB1B 630374 / C4 IRB IR 8014			FIAT (124)
F 18015				
F 18018	SNR AB12888 S05			RENAULT (Super 5 * R9 * R11 * R19 * Clio I * Express I * Express II * Extra MK I * Extra MK II * Rapid)
F 18019	SNR AB41386			RENAULT (Super 5 * R9 * R11 * R19 * Clio I * Clio II * Express I * Express II * Extra MK I * Extra MK II * Kangoo * Kangoo FL * Lutécia * Mégane * Mégane Classic * Mégane Scénic * Rapid * Tahlia * Twingo)
F 18020	NSK B17 126 DDWC3		ALT	BOSCH
F 18021	FAG 566195			MERCEDES BENZ (MB 180)
F 18022	SNR AB12516			RENAULT (Traffic)
F 18023	SKF 440682			
F 18024	FAG 536906C			AUDI (A3 * S3 * TT)
F 18032	SKF 6210ZNRB SNR 6210NRZB KOYO 6210NRZ			
F 18033				
F 18036	KOYO 6217 3BBNCS 9			EATON
F 18037				
F 18038				
F 18039	INA F 45385 KOYO 83549			CASE NEW HOLLAND (30 * TS)
F 18041	NSK BL 210 ZNR C3		V	KOMATSU (Various)
F 18042	FAG 800574A NTN TMB 311 X13 C3			MERCEDES BENZ (G 60 * G 85-6)
F 18043	SKF BB1B 445924 C			PEUGEOT (605 * 806)
F 18046 2RS	S 88501			

04.2 \ Special ball bearings Rodamientos de bolas especiales

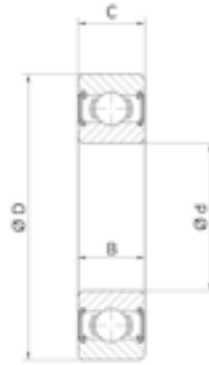

Fersa	d (mm)	D (mm)	C / B (mm)	TYPE
F 18046 ZZ	12,000	32,000	10,000 / 15,350	ESP
F 18047	30,000	75,000	21,000	D
F 18048	32,000	80,000	23,000	D
F 18049	50,000	90,000	22,000 / 16,000	ESP
F 18050	40,000	94,000	26,000	ESP
F 18051	40,000	90,000	23,000	ESP
F 18053	70,000	140,000	26,000	A
F 18054	55,000	116,000	28,000	A
F 18055	60,000	130,000	31,000	A
F 18056	55,000	120,000	29,000	A
F 18058	25,000	55,000	15,000	A
F 18059	80,000	140,000	26,000	A
F 18060	72,000	130,000	25,000	A
F 18062	25,000	62,000	19,000	A
N F 18066	90,000	140,000	24,000	B
N F 18067	22,000	62,000	21,000	D



*ESP For more special drawing details, contact with Fersa / Para más información técnica, contactar con Fersa.

Angular contact ball bearings

Rodamientos de bolas de contacto angular

05.1 \	Special double row angular contact ball bearings / Rodamientos de bolas de doble hilera de contacto angular especiales	82
05.2 \	Standard double row angular contact ball bearings / Rodamientos de bolas de doble hilera de contacto angular estándar	96
05.3 \	Four point angular contact ball bearings / Rodamientos de bolas de cuatro puntos de contacto angular	98
05.4 \	Air conditioning / Aire acondicionado	100

05



05.1 \ Special double row angular contact ball bearings

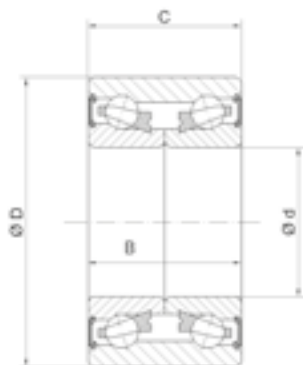
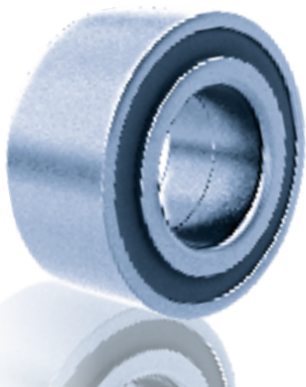

Rodamientos de bolas de doble hilera de contacto angular especiales

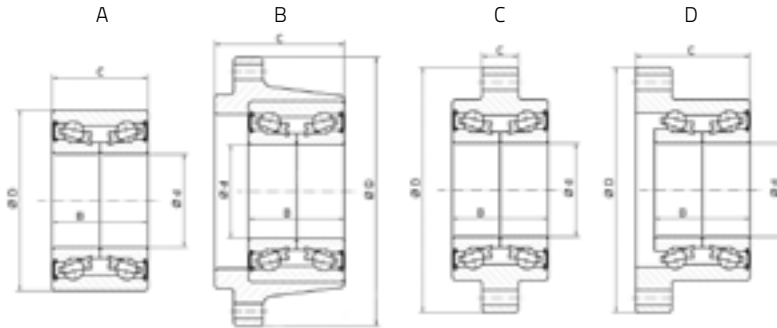

Fersa	d (mm)	D (mm)	C / B (mm)	TYPE
F 16001	30,000	60,030	37,000	A
F 16002	35,000	68,000	37,000	A
F 16004	25,000	56,000	32,000	A
F 16010	30,000	117,000	61,300 / 37,000	B
F 16018	34,000	62,000	37,000	A
F 16019	34,000	64,000	37,000	A
F 16020	34,000	66,000	37,000	A
F 16021	35,000	65,000	35,000	A
F 16022	35,000	66,000	32,000	A
F 16023	35,000	66,000	37,000	A
F 16026	35,000	72,000	33,000	A
F 16027	35,000	72,040	33,000	A
F 16029	37,000	72,000	33,000	A

Type / Tipo



Fersa	CROSS REF.			
F 16001	SKF FAG SNR IRB INA	BA2B 633313 C 545312 GB 10790 S05 IR 8040 F 45721		 DELOREAN (DMC 12) FIAT (124 * 128 * Strada * Uno * X 1/9) LADA (Samara * Signet) LANCIA (Zagato) YUGO
F 16002	SKF FAG SNR IRB INA	BAH 0031 BAH 0031 D 541153 A 567918 GB 10840 S04 IR 8026 F 45951		 FIAT (Duna * Fiorino) SKODA (FAVORIT * FELICIA) VW (CADDY)
F 16004	SKF	BAH 5000 AA		 CITROËN (Ax * Saxo) PEUGEOT (106)
F 16010	SKF SNR IRB	BAF 0013 AD TGB 40490 IR 8505		 ALFA ROMEO (1445 * 146)
F 16018	SKF FAG IRB	BAHB 311316 B 561447 IR 8051		 AUDI (50) VOLKSWAGEN (Derby * Polo)
F 16019	SKF FAG IRB SNR	309726 DA 532066 IR 8041 GB 10884		 DAEWOO (Nexia * Cielo * Lanos * Racer) GM (Aveo) PONTIAC (G3 * Optima) VOLKSWAGEN (Atlantic * Caribe)
F 16020	SKF FAG IRB INA	BAHB 636114 A 580400 IR 8622 F 110487.1		 OPEL (Astra * Combo * Corsa * Kadett * Tigra * Vectra) GM (Chevy)
F 16021	FAG IRB SNR	546238 IR 8042 GB12438S01		 CITROËN (Xantia) RENAULT (Clio * Express)
F 16022	SKF IRB	BAH 5001 A IR 8091		 CITROËN (Ax * Saxo) PEUGEOT (106)
F 16023	SKF FAG	BAH 0023 544307		 VOLKSWAGEN (Golf * Jetta * Lupo * Polo) SEAT (Arosa)
F 16026	SKF FAG IRB SNR	BA2B 446762 B 548083 IR 8055 GB 12094 S10		 CITROËN (AX * C15 * ZX * Xsara) FIAT (Tipo) PEUGEOT (Partner)
F 16027	SKF	BAH 0013 D		 FIAT (LINEA * TEMPRA)
F 16029	SKF IRB SNR	BAH 0051 B IR 8740 GB 40547		 CITROËN (C2 * C3 * Saxo * Xsara) PEUGEOT (106 * 206 * 306)

05.1 \ Special double row angular contact ball bearings



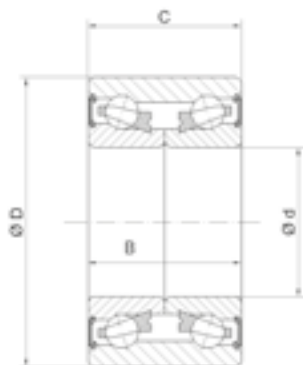
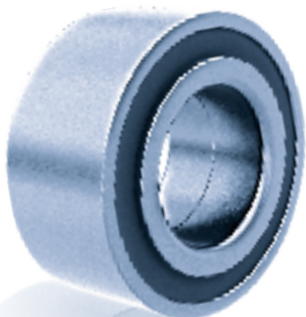





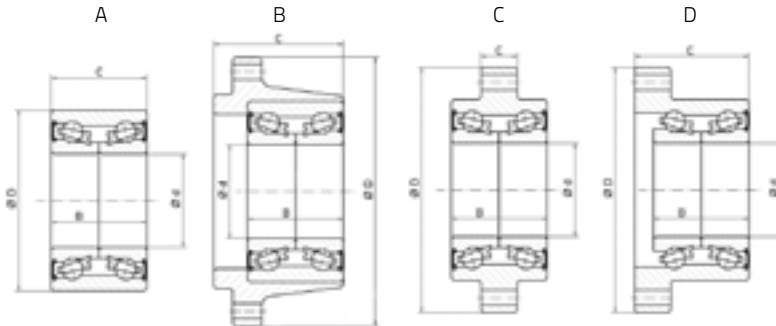











Rodamientos de bolas de doble hilera de contacto angular especiales



Fersa	d (mm)	D (mm)	C / B (mm)	TYPE
F 16030	37,000	72,000	37,000	A
F 16031	37,000	72,040	37,000	A
F 16032	37,000	74,000	45,000	A
F 16033	37,000	139,000	64,000 / 45,000	D
F 16034	37,990	74,020	33,000 / 36,000	A
F 16035	39,000	68,000	37,000	A
F 16036	39,000	72,000	37,000	A
F 16037	39,000	74,000	39,000	A
F 16038	39,000 / 41,000	75,000	37,000	A
F 16039	40,000	72,000	37,000	A

Type / Tipo



Fersa	CROSS REF.			
F 16030	SKF IRB SNR IRB	BAH 0094 IR 8066 GB 40706 F 113175		 NISSAN (Platina) RENAULT (Clio * Kangoo * Laguna I * MEGANE * SCENIC * SAFRANE)
F 16031	SKF FAG IRB SNR	BAH 0012 AD 562398 A IR 8088 GB 12131 503		 ALFA ROMEO (33)
F 16032	SKF FAG IRB NATIONAL	309946 AC 541521 C IR 8513 511020		 BMW (518 * 520 * 524 * 525 * 530 * 535)
F 16033	SKF IRB	BAFB 447318 B IR 8591		 BMW (518 * 520 * 524 * 525 * 530 * 535 * 730 * 735 * 740 * 750 * 840 * 850)
F 16034	SKF FAG IRB NATIONAL	BAH 0041 D 574795A IR 8655 514002		 LEXUS (ES250) NISSAN (SUNNY * ALMERA * LUCINO * SENTRA * TSUBAME * TSURU III) TOYOTA (RAV4)
F 16035	SKF FAG IRB INA NATIONAL	BAHB 311315 BD 540733 IR 8052 F 45747.2 510024		 AUDI (80 * Coupe * 90) FORD (Escort * Ghia * Tempo * Topaz) MERCURY (Cougar * Mystique) VOLKSWAGEN (Corsar * Golf * Jetta * Passat * Santana)
F 16036	SKF FAG IRB SNR INA NATIONAL	BA2B 309639 BA / BAHB 311396 B 542186 A IR 8085 GB 41599 / GB 12776 F 45920.2 513113		 BMW (316 * 318 * 320 * 324 * 325 * M3 * Z3) CHEVROLET (Astra * Zafira) DAEWOO (Cielo * Lanos * NEXIA * Nubira * ESPERO) FORD (Courier * Ecosport * ESCORT * Fiesta * Focus * Fusion * Ikon * KA * PUMA * ORION) LOTUS (ELAN) MAZDA (2) PONTIA (Optima) VOLKSWAGEN (CROSSFOX * GOL * LUPO * POINTER * SAVEIRO * VAN)
F 16037	SKF FAG SNR NATIONAL	BAHB 636096 A 579557 IR 8603 510052		 CHEVROLET (OPTRA) DAEWOO (Leganza) OPEL (ASTRA * CALIBRA * OMEGA * VECTRA) SAAB (9 3 CONVERTIBLE * 9 5 * 900)
F 16038	SKF FAG IRB SNR	BAHB 633815 AA 567447 B IR 8530 GB 12399501		 AUDI (A4 * A6 * 80 * CABRIO * Coupe 90) SKODA (Super B) VOLKSWAGEN (Passat * Santana)
F 16039	SKF FAG IRB SNR NATIONAL	BAHB 311443 B 566719 IR 8095 GB 12320502 510004		 SEAT (CORDOBA * INCA * IBIZA * TOLEDO) VW (CABRIO * CADDY * CORRADO * DERBY * Golf * Jetta * Passat * POLO CLASSIC * VENTO)

05.1 \ Special double row angular contact ball bearings



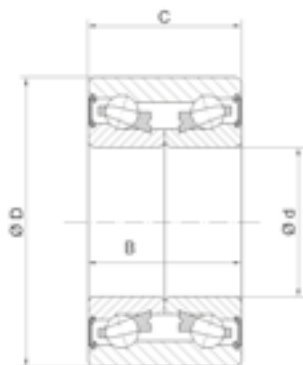
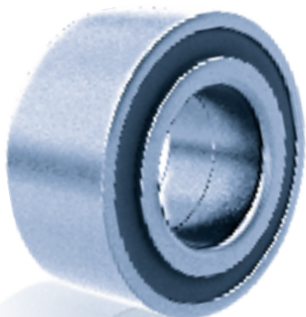





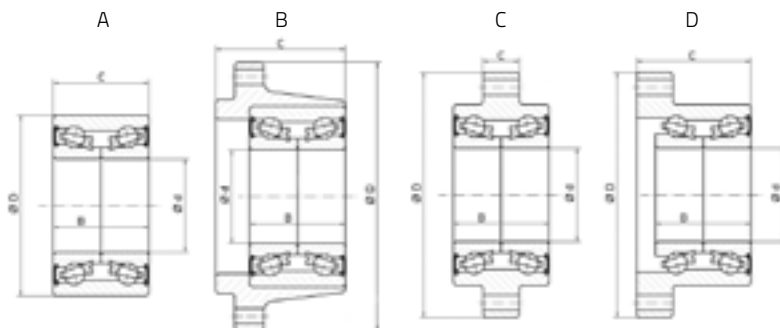















Rodamientos de bolas de doble hilera de contacto angular especiales



Fersa	d (mm)	D (mm)	C / B (mm)	TYPE
F 16040	40,000	74,000	40,000	A
F 16041	40,000	76,040	38,000 / 41,000	A
F 16042	40,000	80,000	30,200	A
F 16043	40,000	80,000	38,100	A
F 16044	39,980	108,000	17,000 / 32,000	C
F 16045	42,000	75,000	37,000	A
F 16046	42,000	75,000	37,000	A
F 16048	42,000	82,000	36,000	A
F 16051	42,000	84,000	39,000	A
F 16052	43,000	79,000	38,000 / 41,000	A
F 16054	43,000 / 45,000	82,000	37,000	A
F 16055	40,000	75,000	37,000	A

Type / Tipo



Fersa	CROSS REF.			
F 16040	SKF FAG IRB	BAH 0049 C 801136 IR 8668		 AUDI (A3 * S3 * TT) SEAT (LEON * TOLEDO) SKODA (OCTAVIA * ROOMSTER) VW (BORA * Golf * NEW BEETLE * Jetta)
F 16041	NSK SNR NATIONAL	40BWD05CA60 IR 8583 513053		 HONDA (ACCORD) MG (ZR) ROVER (25 * 200 * 400 * CABRIO * Coupe)
F 16042	FAG IRB SNR	565636 IR 8006 Y44FB.10394 502		 PEUGEOT (204 * 304 * 305)
F 16043	SNR	GB 10800		 TALBOT (HORIZON * 1300)
F 16044	SNR IRB	TGB 10872 502 IR 8048		 RENAULT (Space)
F 16045	SKF SNR	BAHB 311424 B GB 12010		 BMW (318, 320i, 323, 325, 328 (E36))
F 16046	FAG IRB	545495 IR 8509		 ALFA ROMEO (75 * 90 * GTV) BMW (316 * 318 * 320 * 324 * 325 * M3 * TOURING * CABRIO * Z1 * Z4)
F 16048	SKF FAG IRB SNR NATIONAL	BAH 0171 561481 IR 8086 GB 12163 504 513073		 CITROËN (Berlingo) PEUGEOT (206 * 207 * 306 * 307 * 308 * 405 * 505 * 604 * PARTNER)
F 16051	SKF FAG IRB SNR	BAH 0177 543359 B IR 8101 GB 40549 / GB 10702 503		 RENAULT (20 * 30 * Traffic) VAUXHALL (Arena)
F 16052	SNR NSK NATIONAL	XGB 41999 43BWD08CA103 510030		 ACCURA (EL) HONDA (Civic) MG (ZS) ROVER (45 * 400)
F 16054	SKF IRB NATIONAL	BAH 0011 AB IR 8737 510019		 AUDI (A4 * A8 * ALLROAD * V8 * A8 * Coupe * CABRIO * 80 * 100 * 200) SKODA (SuperB) VOLKSWAGEN (Passat)
F 16055	SKF IRB NATIONAL	BAHB 633966 BB IR 8593 510029		 FORD (Contour * Cougar * Escape * Mondeo) JAGUAR (X TYPE) MERCURY (Cougar * Mystique) VOLVO (S40 * V40)

05.1 \ Special double row angular contact ball bearings



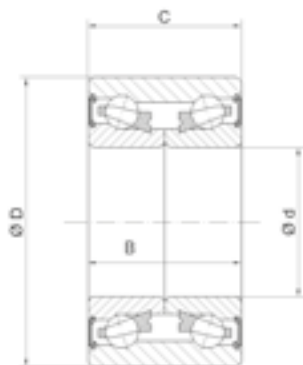
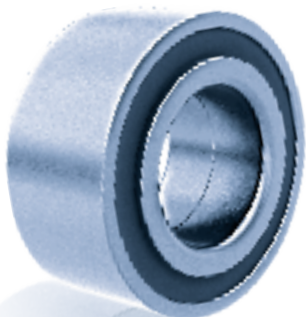





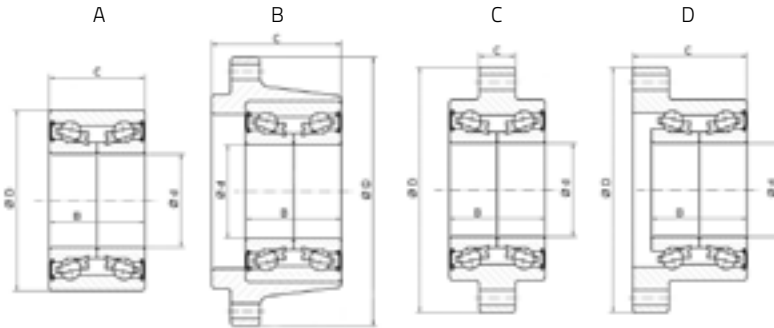

Rodamientos de bolas de doble hilera de contacto angular especiales



Fersa	d (mm)	D (mm)	C / B (mm)	TYPE
F 16056	44,000	82,500	37,000	A
F 16057	38,100	70,000	37,000	A
F 16058	38,000	74,000	50,000	A
F 16059	45,000	84,000	39,000	A
F 16063	45,000	85,000	30,200	A
F 16066	40,000	84,020	38,000	A
F 16068	38,000	72,020	33,000 / 36,000	A
F 16076	51,000	91,000	44,000	A
F 16077	28,000	61,000	42,000	A
F 16078	43,000	82,000	45,000	A
F 16079	40,000	74,000	42,000	A
F 16080	40,000	74,000	36,000	A
F 16081	42,000	76,000	35,000 / 38,000	A
F 16082	45,000	84,000	39,000	A
F 16083	34,000	67,000	37,000	A

Type / Tipo



Fersa	CROSS REF.			
F 16056	SKF IRB SNR NATIONAL	BAH 0174 IR 8618 GB 40246 S02 510087		 CITROËN (EVASION * JUMPY) FIAT (SCUDO * ULYSSE) LANCIA (Zeta) LAND ROVER (FREELANDER) PEUGEOT (806 * EXPERT)
F 16057	SKF FAG NATIONAL	BAHB 636193 C 805921 510055		 DODGE (ATOS * ATTITUDE) HYUNDAI (ACCENT * ATOS * Coupe * GETZ * LANTRA * Tiburon * Verna) KIA (RIO) PEUGEOT (GRAND RAID * PARTNER)
F 16058	NSK NATIONAL	38BWD06D A CA 01 510008		 NISSAN (PULSAR * SUNNY * HIKARI * TSURU II)
F 16059	SKF	BAHB 636149 BC / BAHB 636149 D		 MERCEDES (124 * 190 * Clase C * CLK * Clase E * Clase V * VITO * SL * SLK) CHRYSLER (CROSSFIRE)
F 16063	IRB	IR 8597		 FORD (Transit)
F 16066	SNR	GB 40250 S01		 RENAULT (LAGUNA * Megane * SAFRANE)
F 16068	KOYO NATIONAL	DAC 3872W 8CS81 510007		 TOYOTA (COROLLA)
F 16076	SNR	GB 41688 P		
F 16077	KOYO NATIONAL	DAC 286142 AW 513031		 TOYOTA (Corolla * Hiace * MR2) CHEVROLET (NOVA)
F 16078	KOYO NSK NATIONAL	DAC 43820045 43 BWD 06 510006		 TOYOTA (Camry * Sienna * RAV 4) LEXUS (LX470)
F 16079	KOYO NSK	DAC 40740042 B 40 BWD 12		 TOYOTA (ALVIS * AVENSIS * CELICA * COROLLA * MR2 * Prius * WISH LIMUSINA) PONTIAC (Vibe)
F 16080	NSK NATIONAL	40 BWD 15 A 510061		 NISSAN (Almera * Sentra) MITSUBISHI (LANCER)
F 16081	NSK IRB NATIONAL	40 BWD 06 IR 8650 510009		 NISSAN (ALTIMA * PRIMERA * PRAIRIE * MAXIMA)
F 16082	TIMKEN FAG	TKR 8572 547103E		 MERCEDES BENZ (190 * Clase C * Clase E * SL * SLK) PEUGEOT (605)
F 16083	FAG	803775		 OPEL (COMBO * Corsa * MERIVA * Tigra) GM (Corsa * Corsa NOVO * MERIVA * MONTANA * TORNADO)

05.1 \ Special double row angular contact ball bearings

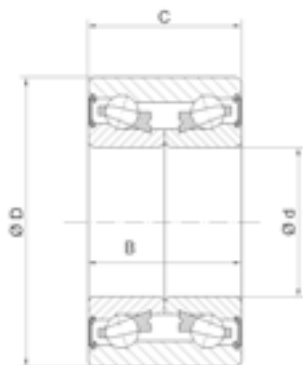
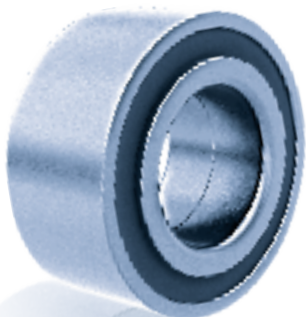

Rodamientos de bolas de doble hilera de contacto angular especiales

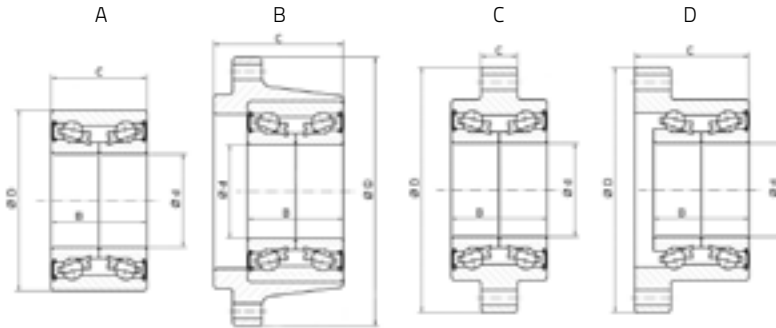

Fersa	d (mm)	D (mm)	C / B (mm)	TYPE
F 16084	44,990	84,070	39,000	A
F 16085	45,000	80,000	45,000	A
F 16086	43,000	80,000	38,000	A
F 16088	42,000	80,000	45,000	A
F 16089	40,000	74,000	40,000	A
F 16090	40,000	80,000	34,000 / 36,000	A
F 16091	40,000	74,000	34,000 / 36,000	A
F 16093	35,000	66,000	33,000	A
F 16094	27,000	134,000	67,600 / 50,000	D
F 16095	28,000	119,000	52,000 / 42,000	D
F 16107	42,000	80,000	37,000	A
F 16108	40,000	84,060	39,700 / 38,800	A
F 16109	49,000	88,000	46,000	A
F 16110	39,000	72,000	37,000	A
F 16115	36,000	68,000	33,000	A

Type / Tipo



Fersa	CROSS REF.			
F 16084	FAG	547103 E		 MERCEDES BENZ PEUGEOT (190 * Vito 605)
F 16085	FAG NSK NATIONAL	564725 AB 42BWD06CA98 510051		 VW (TRANSPORTER)
F 16086	FAG	579943		 FORD (GALAXY) SEAT (ALHAMBRA) VW (SHARAN)
F 16088	SKF FAG SNR NATIONAL	BAH 0028 AA 579943 B GB 35457 510010		 KIA (CARENS * SHUMA * SEPHIA * Spectra) MAZDA (323 * 626 * 6 * MVP * MX 5 * MX 6 * XEDOS 6 * XEDOS 9) FORD (Focus * Fusion * LINCOLN * MKX) LINCOLN (MKZ * Zephir) MERCURY (MILLAN) VOLVO (C 30 * C 70 * S 40 * V 50)
F 16089	SKF	BAH 0049		 KIA (SHUMA * SEPHIA) MAZDA (323 * MX 5 * MX 6)
F 16090	SKF KOYO NATIONAL	BAHB 636187 A DAC 4060 M1 513036		 HYUNDAI (SONATA) MITSUBISHI (GALANT * ECLIPSE * Space * WAGON * Space * RUNNER) EAGLE (Summit Wagon * Talon) PLYMOUTH (Colt * Laser)
F 16091	KOYO NATIONAL	DAC 40740034 / 36 510016		 MITSUBISHI (CARISMA * COLT * LANCER * MIRAGE MONTERO) DODGE (COLT) EAGLE (SUMMIT) PLYMOUTH (COLT) SUZUKI (XL 7 4X2 4X4)
F 16093	SKF SNR	BAH 0015 E GB 12306S02		 FIAT (PANDA * PUNTO * SEICENTO * TIPO CINQUECENTO)
F 16094	NSK	27 BWK 04D3		 NISSAN (NX)
F 16095	NSK	28 BWK 12		 TOYOTA (Corolla)
F 16107	SKF SNR	BAH 0004 AA GB 12955S04		 ALFA ROMEO (145 * 146 * 155 * 164 * GTV * SPIDER) FIAT (BRAVO * Coupe * CROMA * MAREA) LANCIA (DELTA * KAPPA * THEMA)
F 16108	SNR	XGB 40492 S01 P		 RENAULT (Laguna)
F 16109	SNR NSK	GB 40279S01 49BWD01BCA116		 MERCEDES (Clase M)
F 16110	SKF SNR	BAH 0106 D XGB 35447		 FORD (Fiesta * Fusion * Focus) VW (SAVEIRO)
F 16115	NATIONAL	510001		 SUZUKI (Swift)

05.1 \ Special double row angular contact ball bearings



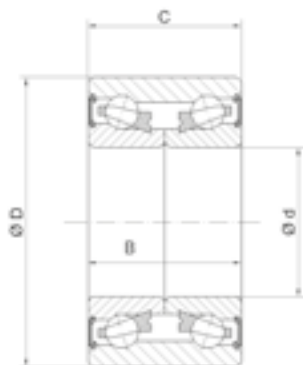
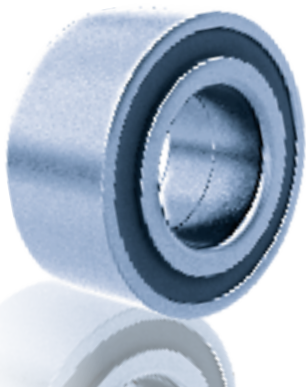



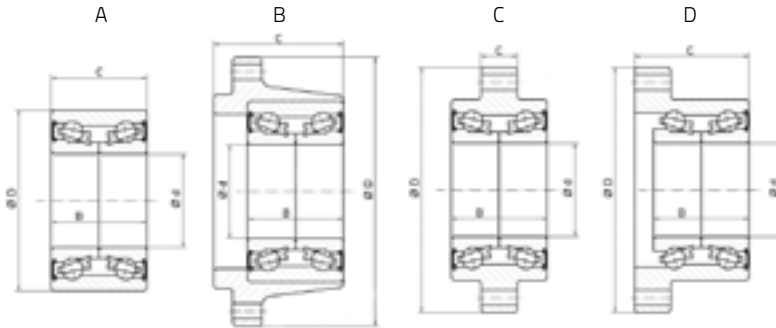

Rodamientos de bolas de doble hilera de contacto angular especiales



Fersa	d (mm)	D (mm)	C / B (mm)	TYPE
F 16117	38,000	73,000	40,000	A
F 16118	43,000 / 45,000	85,000	37,000	A
F 16120	38,000	71,020	33,000/33,00	A
F 16121	45,000	88,020	39,000	A
F 16123	45,000	86,000	39,000	A
F 16124	38,000	72,000	40,000	A
F 16128	45,000	86,000	39,000	A
F 16129	25,000	52,000	42,000	A
F 16193	43,000	78,000	44,000	A
F 16194	42,000	76,000	39,000	A
F 16195	42,000	76,000	37,000 / 40,000	A
F 16196	43,000	76,000	43,000	A
F 16197	42,000	76,000	33,000	A
F 16198	40,000	76,000	33,000	A
F 16199	47,000	81,000	53,000	A
F 16200	35,000	64,000	37,000	A
F 16201	35,000	72,000	34,000	A

Type / Tipo



Fersa	CROSS REF.				
F 16117	NTN NATIONAL DE 08A48LLCS46PX1/ L260 510015			HONDA (CIVIC IV * CR V * LOGO)	
F 16118	SKF BAHB 636214 A			AUDI (A4 * A8)	
F 16120	KOYO DAC3871W2CS70			TOYOTA (Corolla)	
F 16121	SNR GB 40300			RENAULT (AVANTTIME * Espace III)	
F 16123	SNR GB 40575 S02			NISSAN (Primastar * Opel Vivaro)	
F 16124	SNR NACHI GB 35275 38BVV07 10G			HONDA (CIVIC I II III * ROVER 200)	
F 16128	SNR XGB 40575 S02 P			NISSAN (Primastar) OPEL (Vivaro) RENAULT (Space)	
F 16129	SNR NTN GB 35098 AU 0501			OPEL (AGILA) SUZUKI (IGNIS)	
F 16193	NTN NATIONAL AU 0933 510089			HONDA (Civic)	
F 16194	NSK NATIONAL 27 BWK 04D3 513058			CHRYSLER (Petit Cruiser) DODGE (Neon) FORD (COUGAR * MUSTANG * TAURUS * THUNDERBIRD * WINDSTAR) LINCOLN (Mark VIII) MERCURY (Cougar * Sable)	
F 16195	SKF FAG KOYO NATIONAL BAHB309796A 547059 DAC4276W 513006			CHRYSLER (DART K * LEBARON * NEW YORKER * PHANTOM * SHADOW * VOLARE K) DODGE (CARAVAN) PLYMOUTH (VOYAGER)	
F 16196	NSK NATIONAL 43 BWD 12A JB 5C01 510060			NISSAN (Altima * Maxima * X-Trail) INFINITI (i30 * i 35)	
F1 6197	NATIONAL 510057			DODGE (Neon) CHRYSLER (PT CRUISER)	
F 16198	NATIONAL 510032			DODGE (Neon)	
F 16199	KOYO NATIONAL DAC4781W 510028			NISSAN (Quest)	
F 16200	SKF KOYO NATIONAL BAH 0042 DAC3564A1 510014			CITROËN (Evasion Jumpy) DAIHATSU (CHARADE)	
F 16201	NKE LEMKEN SNR CLAAS KOYO NATIONAL SKF 3198750 F214101-1 GB-40582 939717.0 DAC 35720034 A 510014 VKBA 857D			HONDA (Accord * Civic * Prelude)	

05





05.4 \ Air conditioning Aire acondicionado

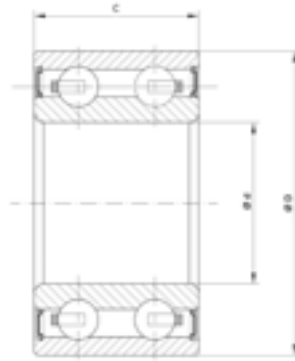
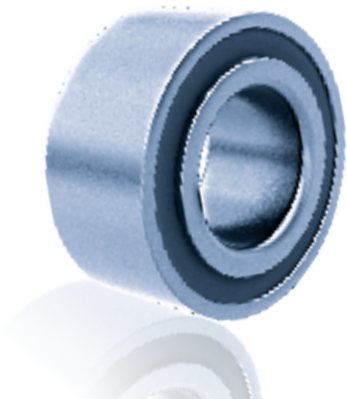

Fersa	d (mm)	D (mm)	C / B (mm)
F 16097	30,000	52,000	22,000
F 16098	30,000	55,000	23,000
F 16099	35,000	50,000	20,000
F 16100	35,000	55,000	20,000
F 16101	35,000	52,000	22,000
F 16102	40,000	62,000	24,000
F 16103	40,000	62,000	20,625
F 16104	30,000	62,000	27,000
F 16189	40,000	57,000	24,000
F 16190	40,000	62,000	20,600 / 24,000



Fersa		CROSS REF.		COMPRESSOR TYPE
F 16097	NACHI NSK KOYO NTN	30 BG 05S 2G - 2DS 30 BD 5222 FX DAC 3052- 32 RR9 DS 10Z	Toyota, Daihatsu, HINO, Honda, Mitsubishi, Mazda, FUJI, Isuzu, Jaguar, Chrysler, BMW USA, GM, Honda USA, John Deere, Rover, Toyota UK, Fiat, Hyundai, Kia, Mercedes Benz, Porsche	Denso
F 16098	NACHI NSK KOYO	30 BG 05S 5G - 2DS 30 BD 40 A - T1Z DDF1 30 BG 05 S5G - 2DST2	Ford, Hyundai, Kia, Mitsubishi	Behr - Bosch - Diesel Kiki - Nihon - York
F 16099	NACHI NSK	35 BG 05S 7G 2DS 35 BD 5020 DUK	Ford, Mitsubishi, Nissan, Honda	Delphi - Mitsubishi - Sanden - Seiko Seiki
F 16100	NACHI NSK KOYO NTN	35 BG 05S 10G 2DL 35 BD 219T - 1Z DDU K8 DAC 3555 RD 3H - 83 A 694 30 BG 04 S15G - 2DST	GM, Nissan, Chrysler, Kia, Hyundai, Honda	Diesel - Kiki - Matsushita - Nihon - Sanden - Seltec
F 16101	NACHI NSK	35 BG 52 22 - 2DS 35 BD 52 22 DF X7	Mercedes Benz, Audi, Volkswagen	Delphi - Denso
F 16102	NACHI NSK KOYO NTN	40 BG S1 1G - 2DS DF 0865 83 A 5518 40 BD 219T 12 DDU	Toyota, Daihatsu, Mitsubishi, Rover, Volkswagen BRASIL, Fiat BRASIL	Denso - Hitachi - Nihon - Sanden - Seiko Seiki
F 16103	NACHI NSK	40 BG 620 20 - 2DL 40 BD 49V	GM , Daewoo	Keihin - Seiko Seiki
F 16104	NACHI KOYO NTN	30 BG S 12G - 2DS BD 30 - 11 A 5206 #37	Chrysler	Chrysler - White
F 16189	NACHI NSK KOYO NTN	40 BG 05S 2G - 2DS 40 BD 45 T12 DDU 40 BD 45 T12 2TS2 - DF 0882 LL BCS	Mitsubishi, Volkswagen	Mitsubishi - Sanden
F 16190	NACHI NSK KOYO NTN	40 BG S 12G - 2DS 40 BD 49 AWT12 DDU 40 BD 49 AW 5908 - 2RSWE	Ford, Hino, Mazda, Chrysler	Denso



Thrust ball bearings

Rodamientos axiales de bolas

06.1 \	Thrust ball bearings / Rodamientos axiales de bolas	104
06.2 \	Clutch release bearings / Rodamientos de embrague	106

06

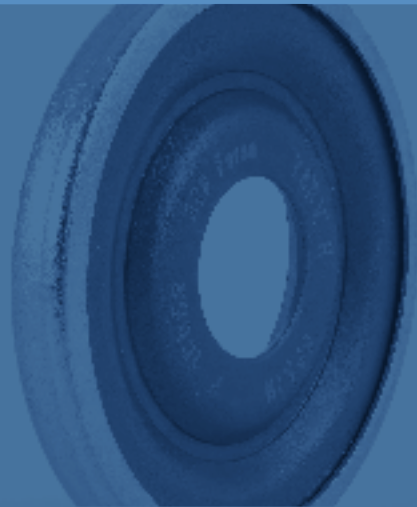

07

Insert bearings

Rodamientos autoalineables

07

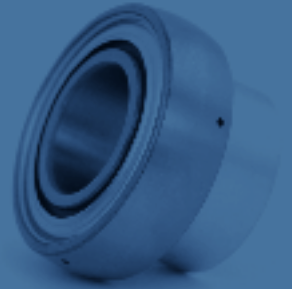
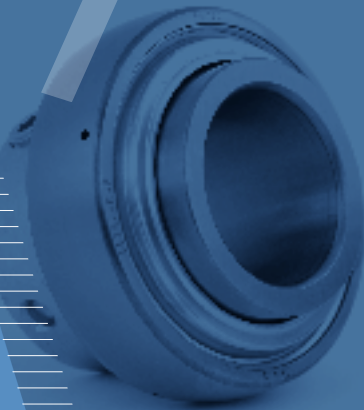



Cylindrical roller bearings

Rodamientos de rodillos cilíndricos

08.1 \	Standard cylindrical bearings / Rodamientos cilíndricos estándar	114
08.2 \	Special cylindrical bearings / Rodamientos cilíndricos especiales	118

08

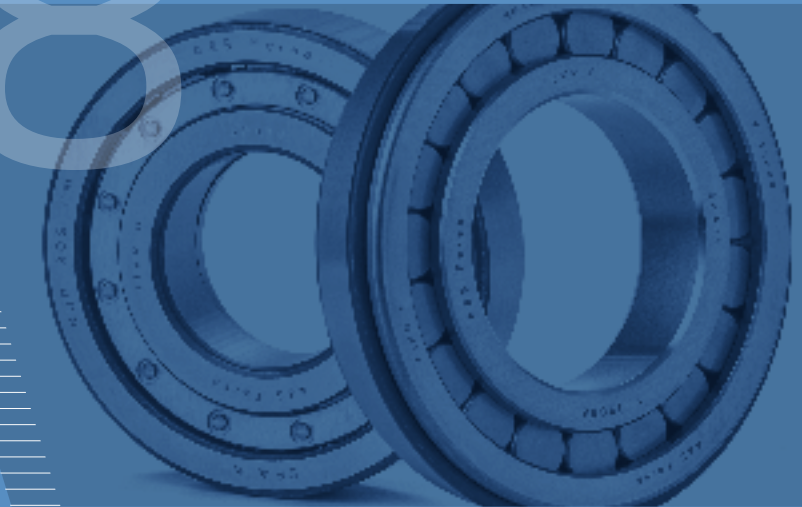

08.1 \ Standard cylindrical bearings Rodamientos cilíndricos estándar



Fersa	d (mm)	D (mm)	B (mm)
N SERIE			
N 206 FM	30,000	62,000	16,000
N 211 FMNR/C4	55,000	100,000	21,000
N 307 FM	35,000	80,000	21,000

NJ SERIE			
NJ 210 FM/C3	50,000	90,000	20,000
NJ 215 F/C3	75,000	130,000	25,000
NJ 215 FP/C3	75,000	130,000	25,000
NJ 305 F	25,000	62,000	17,000
NJ 306 FM	30,000	72,000	19,000
NJ 308 FM	40,000	90,000	23,000
NJ 309 FM	45,000	100,000	25,000
NJ 310 FM	50,000	110,000	27,000
NJ 406 FM/C3	30,000	90,000	23,000
NJ 416 FM/C3	80,000	200,000	48,000
NJ 1024 FM	120,000	180,000	28,000
NJ 2205 FM/C3	25,000	52,000	18,000
NJ 2222 FM/C3	110,000	200,000	53,000
NJ 2315 FM/C4	75,000	160,000	55,000
NJ 2322 FM/C3	110,000	240,000	80,000

NU SERIE			
NU 202 FM/C3	15,000	35,000	11,000
NU 206 FM	30,000	62,000	16,000
NU 208 FMN	40,000	80,000	18,000
NU 208 FMN/C3	40,000	80,000	18,000
N NU 208 FN	40,000	80,000	18,000
NU 209 FMN	45,000	85,000	19,000
NU 209 FMN/C3	45,000	85,000	19,000
N NU 209 FN/C3	45,000	85,000	19,0
NU 308 FM	40,000	90,000	23,000
NU 309 FM	45,000	100,000	25,000
NU 309 FMN	45,000	100,000	25,000
NU 309 FMNR/C3	45,000	100,000	25,000

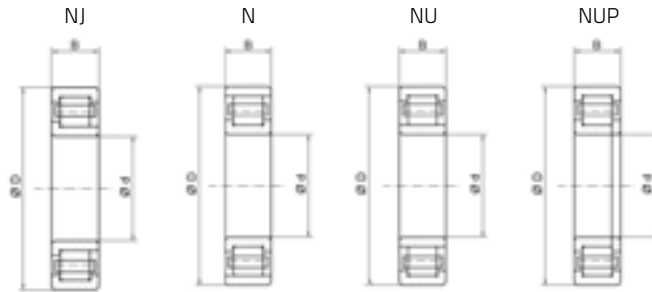

Suffixes / Sufijos

- C3** Internal clearance greater than normal / Juego radial mayor que el normal
M Machined brass cage / Jaula de latón
N Snap ring groove in outer ring / Ranura en aro exterior
NR Snap ring groove and snap ring in outer ring / Ranura y anillo elástico en aro exterior
P Polyamide cage / Jaula de poliamida

Fersa	d (mm)	D (mm)	B (mm)
NU 310 FM	50,000	110,000	27,000
NU 310 FM/C3	50,000	110,000	27,000
NU 310 FMN/C3	50,000	110,000	27,000
NU 1008 FM	40,000	68,000	15,000
NU 1011 FM	55,000	90,000	18,000
NU 2207 FM	35,000	72,000	23,000
NU 2215 FM	75,000	130,000	31,000
NU 2216 FM	80,000	140,000	33,000
NU 2306 F	30,000	72,000	27,000
NU 2306 F/C3	30,000	72,000	27,000
NU 2306 FM/C3	30,000	72,000	27,000
NU 2307 F	35,000	80,000	31,000
NU 2307 F/C3	35,000	80,000	31,000
NU 2307 FM/C3	35,000	80,000	31,000

NUP SERIE			
Fersa	d (mm)	D (mm)	B (mm)
NUP 206 FM	30,000	62,000	16,000
NUP 209 FM	45,000	85,000	19,000
NUP 211 FM/C3	55,000	100,000	21,000
NUP 212 FM	60,000	110,000	22,000
NUP 213 FPNR/C3	65,000	120,000	23,000
NUP 304 FM/C3	20,000	52,000	15,000
NUP 307 FP/C3	35,000	80,000	21,000
NUP 308 FM	40,000	90,000	23,000
NUP 308 FM/C3	40,000	90,000	23,000
NUP 308 FMNR/C3	40,000	90,000	23,000
NUP 308 FP	40,000	90,000	23,000
NUP 309 FM	45,000	100,000	25,000
NUP 309 FM/C3	45,000	100,000	25,000
NUP 309 FMN	45,000	100,000	25,000
NUP 309 FN/C3	45,000	100,000	25,000
NUP 309 FP	45,000	100,000	25,000
NUP 310 FM/C3	50,000	110,000	27,000
NUP 310 FNR/C3	50,000	110,000	27,000
NUP 310 FP	50,000	110,000	27,000

08.2 \ Special cylindrical bearings Rodamientos cilíndricos especiales

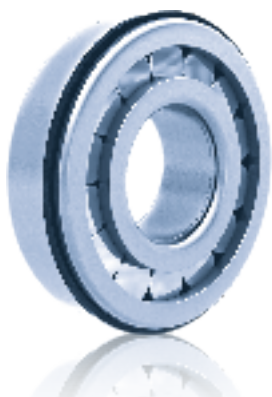



Type / Tipo

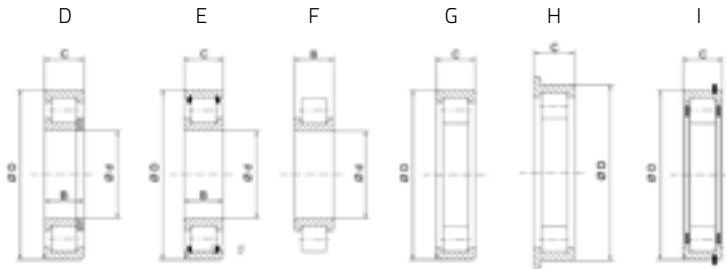

Fersa	d (mm)	D (mm)	T (mm)	TYPE
F 19001	45,000	100,000	36,000	A
F 19002	45,000	100,000	25,000	D
F 19003	45,000	100,000	25,000	D
F 19004	25,000	52,000	18,000 / 20,600	D
F 19005	-	54,600	22,000	G
F 19006	40,000	90,000	23,000	D
F 19008	80,000	150,000	27,500 / 28,000	B
F 19009	60,000	130,000	31,000	B
F 19010	65,000	140,000	33,350	B
F 19011	60,000	110,000	22,000	B
F 19012	35,000	80,000	23,000	A
F 19013	40,000	90,000	27,000 / 24,900	D
F 19014	38,000	90,000	23,000 / 22,000	D
F 19015	45,000	95,000	28,000 / 32,000	A
F 19016	63,000	-	34,800	C
F 19019	30,000	-	26,000	C
F 19020	35,000	80,000	22,000	D
F 19022	84,980	150,000	27,500 / 28,000	B
F 19023	25,000	52,000	18,000	D
F 19024	30,000	59,000	13,000 / 15,000	A
F 19025	30,000	62,000	20,000	E
F 19026	50,000	90,000	23,000	E
F 19029	25,000	52,000	21,000	A

Type / Tipo



Fersa	CROSS REF.				
F 19001	FAG	805262			SCANIA (R780 * R782 * RV 761)
F 19002	SKF	NJ 309 VHNR.C4			SCANIA (R751 * R752 * RV 770 * RV760)
F 19003	SKF	NUP 309 NR.C4			
F 19004	NACHI	NUPK 2205 S13			
F 19005		TJ 600 167			
F 19006	SKF	NJ 308 VH.NR.C4			SCANIA (R640 * R651 * R652 * R653 * RB652)
F 19008	SKF FAG	BC1B 319552 566616 B			ZF (85-1350 * 16K-130 * 16K-160 * 16K-190 * 16S-130 * 16S-160 * 16S-190 * 16S-1300 * 16S-1600 * 16S-1650)
F 19009	SKF FAG	635245 540106			ZF (85-1350 * 16K-130 * 16K-160 * 16K-190 * 16S-130 * 16S-160 * 16S-190 * 16S-1300 * 16S-1600 * 16S-1650)
F 19010	FAG	805449			ZF (16S-130 * 16S-160 * 16S-190 * 16S-1300 * 16S-1600 * 16S-1650 * 16S-1900)
F 19011	SKF FAG	315070 B 512099 TVP2			MERCEDES BENZ (G3-50 * G3-60D)
F 19012	FAG	510148 A			MERCEDES BENZ (1113 * 1214 * 1218 * 1414 * 1418 * 1618)
F 19013	INA	F210540			MERCEDES BENZ (HL4)
F 19014	SKF	BC1B 246747			SCANIA (R641 * R642)
F 19015	SKF INA	314984 F 45814			MERCEDES BENZ (HL5)
F 19016	INA	F 90836.1A			ZF (16K-160 * 16K-190 * 16S-130 * 16S-1300 * 16S-1600)
F 19019	FAG INA	512533 31173			ZF (4K-120,4K 121 * 5K-90 * 5K-91,5K 110 * 5S-111)
F 19020	INA	F 45864.1			MERITOR (RS 230+MS 235 * RS23 240+MS 245)
F 19022	FAG	NUP 524213M			ZF (4K 120,4K 121 * 5K 90 * 5K 91,5K 110 * 5S 111)
F 19023	NACHI	NUPK 2205 S1 NR			
F 19024	RHP	RJ 2022			
F 19025	SKF	2206 VF 153B			
F 19026	SKF	N 2210 W			
F 19029	SKF	BC1B 635251			FIAT (Duna * Uno * Spacio * Vivace * Brio * 147)

08.2 \ Special cylindrical bearings Rodamientos cilíndricos especiales

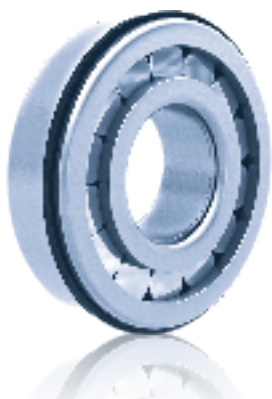

Type / Tipo



Fersa	d (mm)	D (mm)	T (mm)	TYPE
F 19030	49,930	80,000	15,000	E
F 19031	30,000	61,935	19,050	E
F 19032	24,000		17,000	F
F 19033	40,000	90,000	25,000	E
F 19034	40,000	90,000	23,000	E
F 19035	35,000	72,000	20,600	E
F 19037	35,000	-	25,000	C
F 19038	63,000	-	37,500	C
F 19039	80,000	140,000	33,500	B
F 19040	25,000	62,000	17,000 / 19,000	E
F 19042	60,000	110,000	28,000	A
F 19043	34,993	80,000	23,000	A
F 19044	45,000	100,000	25,000	A
F 19045	30,000	61,935	23,813	E
F 19046	50,000	100,000	25,000	B
F 19047	60,000	116,000	28,000	B
F 19048	36,000		20,000	F
F 19055	15,875	47,000	14,000	A
F 19061	67,000	-	32,000	C
F 19062	67,000	-	38,000	C
F 19063	45,000	100,000	31,000	E
F 19064	65,000	140,000	33,000	B
F 19065	40,000	-	29,000	C
F 19066	35,000	62,000	16,700 / 19,000	A
F 19067	38,000	83,000	25,400	E
F 19068	-	62,000	16,000	G
F 19069	-	80,000	26,500	G

Type / Tipo

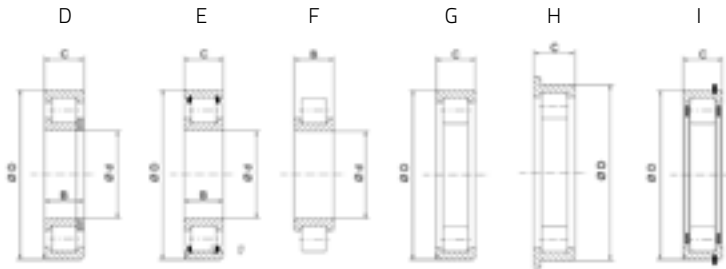

Fersa	CROSS REF.				
F 19030	FLT	CBK 238			
F 19031	FLT	CBK 239			
F 19032	TORRINGTON	544740 B			
F 19033	TORRINGTON	RU 9008 UM			MERITOR (900)
F 19034	TORRINGTON	MU 1308 UM			EATON (RS440)
F 19035	TORRINGTON	RU 1570 UM			DANA SPICER (N400)
F 19037	INA	F-88545			ZF (16K-160 * 16K-190 * 16S-130 * 16S-1300 * 16S-1600)
F 19038	INA	F-88816.2			ZF (16S-160 * 16S-190)
F 19039	SKF FAG	BC1B 312219 805450			ZF (16S 1650)
F 19040	TORRINGTON	MU1305TDM			EATON (16244)
F 19042	FAG	804339			ZF (S5 680 * S6 680)
F 19043	FAG	510148 B			MERCEDES BENZ (HL4)
F 19044	FAG INA	508204 E.TVP 561521			MERCEDES BENZ (G3-36 * G3-40 * G3-50 * G3-60)
F 19045	SNR	ETR 122205			
F 19046	SKF	BC1B 322467			MERCEDES BENZ (G3-45 * G3-55)
F 19047	SKF	BC1B 322172 A			MERCEDES BENZ (G3-45 * G3-55)
F 19048	INA	F-93666.2		SB	FORD (6600 * 6610)
F 19055	RHP	RJ 2023			
F 19061	INA	F-211413.2			ZF (16S-150 * 16S-151)
F 19062	INA	F-211408.5			ZF (16S-220 * 16S-221)
F 19063	SKF	BC1B 320308 A			ROCKWELL (U167 * U177 * U180)
F 19064	SKF	BC1B 319546C / VB017			
F 19065	SKF	BC1B 246037 A			VOLVO (R1400 * R1700 * SR1400 * SR1700 * SR2000 * SR2400)
F 19066	INA	F-43710.1		SS	VOLKSWAGEN (Transporter)
F 19067	LBC	4302712			
F 19068	TORRINGTON	M 1206 EL			GMC (1500 * 3000)
F 19069	INA	F-237594			MERCEDES BENZ (G3/60 * G3/85)

08.2 \ Special cylindrical bearings Rodamientos cilíndricos especiales

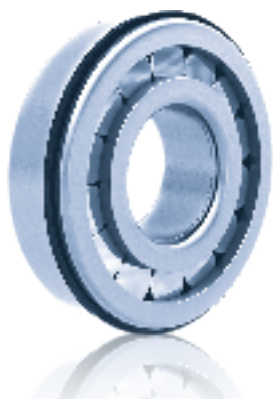

Type / Tipo



Fersa	d (mm)	D (mm)	T (mm)	TYPE
F 19070	50,000	110,000	32,300 / 27,000	A
F 19071	50,000	110,000	32,300 / 27,000	A
F 19075	30,000	-	23,000	C
F 19076	38,000	94,000	33,000 / 31,500	D
F 19077	35,000	80,000	21,000	E
F 19078	30,000	80,000	21,000	E
F 19079		55,000	20,000	G
F 19080	45,000	100,000	36,000	A
F 19081	45,000	100,000	31,000	A
F 19083	30,000	80,000	21,000	E
F 19084	35,000	90,000	23,000	E
F 19085	45,000	100,000	25,000	E
F 19086	35,000	72,000	26,988	E
F 19087	77,000	101,000	29,000	C
F 19088	60,000	110,000	22,000	E
F 19089	40,000	94,000	30,000	A
F 19090	37,000	57,000	31,000	C
F 19091	30,000	72,000	19,000	D
F 19093	25,000	57,000	18,000	A
N F 19094	38,000	89,600	25,400	A
F 19095	28,500	47,600	32,000	C
F 19096	30,000	62,000	24,000	A
F 19097	55,000	104,000	27,000	A
F 19099	35,000	80,000	26,000	E
F 19100	35,000	80,000	21,000	E
F 19101	55,000	100,000	21,000	A

Type / Tipo

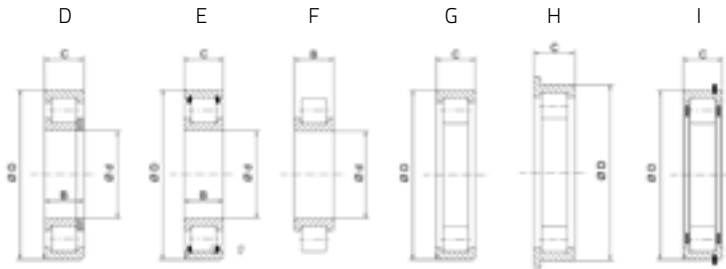

Fersa	CROSS REF.				
F 19070	SKF	BC1 0058			EATON FULLER (FSV 8209A)
F 19071	SKF	BC1 0125			EATON FULLER (FSV 8209A)
F 19075	INA	87486			ZF (8S-1350 * 16K-130 * 16S-130 * 16S-1300 * 16S-1350)
F 19076	FAG	580989			SCANIA (R560 * R660)
F 19077	TORRINGTON	MU 1307 TM			DANA (14136)
F 19078	TORRINGTON	MUS 1307 TM			EATON (D600)
F 19079	NACHI	31 RUKSS2N C3			
F 19080	SKF	NJG 2309 VH/C3 VB027			VOLVO (EV90 * EV91)
F 19081	FAG SKF	563809 BC1B 322722			DAF (1347)
F 19083	TORRINGTON	MUS1307UM			EATON (21065T)
F 19084	TORRINGTON	MUB1308UM			EATON (DP440P * DT440P)
F 19085	TORRINGTON	BS500192S			FULLER (RTL0 16918)
F 19086	TORRINGTON	MUB5207UM			EATON (23070T * 23070P)
F 19087	INA	F-229852			EATON FULLER (10 speeds)
F 19088	TORRINGTON	MU 1212 RUMW3			EATON (RTL0 16918)
F 19089	FAG	575867			MAN (HY-1175)
F 19090	INA	F 224451.04			MERCEDES BENZ (G60 * G85)
F 19091	INA	F-53597		AC	MERCEDES BENZ
F 19093	KOYO	O5NU0618-IVH	LCV		HINO (300) VOLKSWAGEN (Vochobus)
N F 19094	TORRINGTON	BS226539V			EATON FULLER (10 speeds)
F 19095	TORRINGTON	BS 500082			FULLER (RTL0 16918)
F 19096	INA	F-110214.1			MERCEDES BENZ (HL2)
F 19097	INA	F-221302.01			SCANIA (1408178)
F 19099	TORRINGTON	MUB7307UM			DANA (DS402 * RS402)
F 19100	TORRINGTON	MUB1307UBM			DANA (127484)
F 19101	TORRINGTON	MSN 211 REX			EATON (20899)

08.2 \ Special cylindrical bearings Rodamientos cilíndricos especiales



Type / Tipo



Fersa	d (mm)	D (mm)	T (mm)	TYPE
F 19105	65,000	160,000	37,000	A
F 19106	65,000	160,000	37,000	A
N F 19107	45,000	100,000	25,000	E
N F 19108	55,000	100,000	21,000	A
N F 19111	40,000	60,000	26,000	I
N F 19112	40,000	90,000	23,000	D
N F 19116	37,000	80,000	26,000	A
N F 19117	-	100,000	25,000	I
N F 19118	30,000	-	23,000	C
N F 19119	40,000	90,000	23,000	E
N F 19120	30,000	80,000	26,000	E
N F 19121	45,000	85,000	19,000	A

Type / Tipo

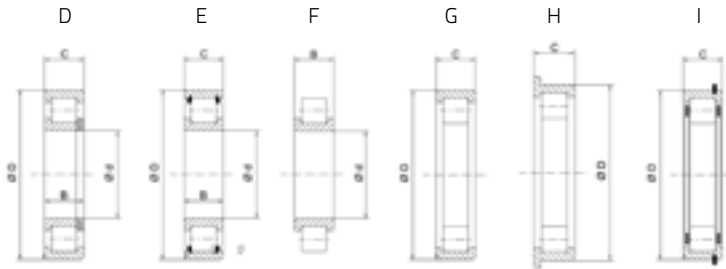

Fersa	CROSS REF.				
F 19105	FAG	539090 A			VOLVO (R61 * SR61 * SR62)
F 19106	FAG	524625			VOLVO (SR62)
N F 19107	BOWER	MU 1309 UM			EATON (AXLE MODEL 23105-D)
N F 19108	BOWER	MA 1211 EL			SPICER (4954*CM49*CM4954* ES066-7B*ES42-5*ES43-5* ES46-5A*ES52-5*ES52-7*ES53-5* ES56-5A*ES56-7*ES65-7*ES066-7)
N F 19111	INA	F-89034			ZF (9S-75)
N F 19112	FAG	520550			VOLVO (EV87 * EV 80 * EV80B)
N F 19116	INA	F-237594 + F-226559.41			MERCEDES BENZ (G60-6 * G85-6)
N F 19117	TORRINGTON	MB1212GEXR			SPICER (ES066-7B*ES52-7* ES56-7*ES65-7*ES066-7)
N F 19118	TORRINGTON	MU5206L			SPICER (4954 * CM49 * CM4954 * ES066-7B * ES42-5 * ES43-5 * ES46-5A * ES52-5 * ES52-7 * ES53-5 * ES56-7 * ES65-7 * ES066-7 * ES56-5A)
N F 19119	TORRINGTON	MU1308TVWS			EATON (5/7/8/9/10/13/15 speeds)
N F 19120	TORRINGTON	MUSB 7307 UM			EATON (DS341(P) * RS341 * DA402(P) * DS402(P) * RA402 * RS402 * DS403(P) * RS403 * DS451-P * RS451)
N F 19121	TORRINGTON	MA 1209 EL			EATON (4D3*34DP*34DS*34DT*38D3 *38DP*38DS*38DT*42D3*42DP* 42DT*50DP*50DT*DP340*DS340* DT340*DC341(P)*DP341(P)* DS341(P)*DT341(P)*DP380- DS380(P)*DT380(P)*DC381(P)* DP381(P)*DS381(P)*DT381(P)* DC386-P*DP386-P*DS386-P* DT386-P*DP400(P)*DS400-P* DT400(P)*DC401-P*DP401(P)* DS401-P*DT401(P)*DA402(P)* DC402(P)*DP402(P)*DS402(P)* DT402(P)*DS403(P)*DC406-P* DP406-P*DS406-P*DT406-P* DC451-P*DP451-P*DS451-P* DT451-P*DC3416-P*DP3416-P* DS3416-P*DT3416-P*DC4026-P* DP4026-P*DS4026-P* DT4026-P)
					MACK (TR107*TRDXL107*TRL1076* TRL1078*TRL10760*TRL10780)

09

Special needle roller bearings

Rodamientos de agujas especiales

09



09\ Special needle roller bearings Rodamientos de agujas especiales

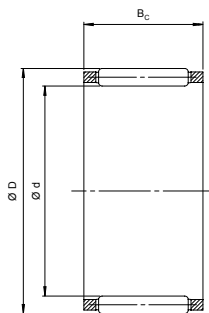
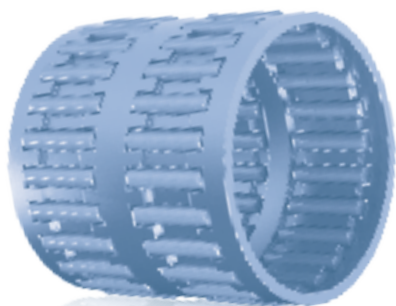

Fersa	d (mm)	D (mm)	B _c (mm)
N F 17003 K	40,000	60,000	3,000
F 17031 K	75,000	83,000	55,000
F 17032 K	78,000	86,000	35,000
F 17033 K	42,000	50,000	51,000
F 17034 K	89,000	97,000	40,000
F 17035 K	85,000	93,000	53,000
F 17038 K	92,000	100,000	53,000
F 17039 K	96,000	104,000	55,000
F 17040 K	90,000	98,000	40,500
F 17041 K	45,000	57,000	21,000
F 17043 K	65,000	70,000	20,000
F 17044 K	70,000	76,000	20,000
F 17045 K	50,000	55,000	20,000
F 17046 K	55,000	60,000	20,000
F 17051 K	82,000	90,000	37,000
F 17052 K	62,000	70,000	37,000
F 17053 K	70,000	78,000	37,000
F 17054 K	45,000	53,000	21,000
F 17056 K	60,000	68,000	32,000

Fersa	CROSS REF.				
N F 17003 K					
F 17031 K	INA	F-57368.01			MERCEDES BENZ (G4-110 * G131-9 * G180-16 * G200-16 * G210-16 * G211-12 * G211-16 * G230-16 * G240-16 * G260-16 * G04-130 * G04-160) ZF (4K-120 * 4S-120 * 8S-180)
F 17032 K	INA	F-92625			MERCEDES BENZ (G4-110 * G100-12 * G180-16 * G200-16 * G210-16 * G211-16 * G230-16 * G240-16 * G260-16 * G280-16 * G04-160 * G0210-6)
F 17033 K	INA	F-207054			MERCEDES BENZ (G155-9 * G200-16 * G210-16 * G211-16 * G221-9 * G230-16 * G231-16 * G240-16 * G241-16 * G260-16 * G280-16)
F 17034 K	INA	F-219518			MERCEDES BENZ (G131-9 * G210-16 * G211-16 * G221-9 * G230-16 * G231-16 * G240-16 * G260-16)
F 17035 K	INA	F-95451.02			MERCEDES BENZ (G125-16 * G155-9 * G210-16 * G211-16 * G240-16 * G260-16)
F 17038 K	INA	F-211412.03			ZF (16S-150 * 16S-151)
F 17039 K	INA	F-212874.01			ZF (16S-150 * 16S-151)
F 17040 K	INA	F-212875.01			ZF (16S-150 * 16S-151)
F 17041 K	INA	F-217112			ZF (16S-150 * 16S-151)
F 17043 K					EATON (FS-5306A * FS-6206A * F-6306A)
F 17044 K					EATON (FS-5306A * FS-6206A * F-6306A)
F 17045 K					EATON (FS-5306A * FS-6206A * F-6306A)
F 17046 K					EATON (FS-5306A * FS-6206A * F-6306A)
F 17051 K	INA	F-58242			ZF (5K-110 * 5S-110)
F 17052 K	INA	F-58723			ZF (5K-110 * 5S-110 * 5S-130)
F 17053 K	INA	F-87259			ZF (4K-120 * 4S-120 * 5K-110 * 5S-110 * S6-65 * S6-85)
F 17054 K	INA	K 45x53x21 A			ZF (4S-120 * 4S-150 * 5K-110 * 5S-110 * 16K-130 * 16K-160 * 16S-112 * 16S-130 * 16S-150 * 16S-160 * 16S-190 * 16S-200 * AK5-45 * AK 6-80 * AK6-90 * S4-90 * S5-45 * S6-65 * S6-72 * S6-90)
F 17056 K	INA	F-205901.01			ZF (9S-75)

09\ Special needle roller bearings Rodamientos de agujas especiales

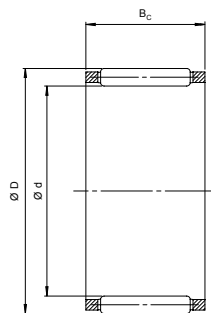
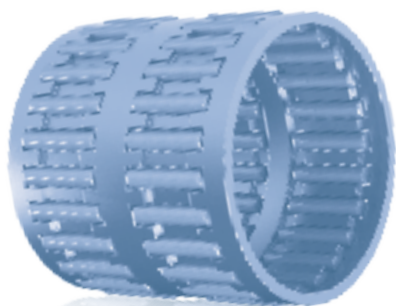

Fersa	d (mm)	D (mm)	B _c (mm)
F 17057 K	67,000	75,000	37,000
F 17058 K	67,000	75,000	44,000
F 17059 K	60,000	68,000	41,700
F 17060 K	50,800	60,325	25,400
F 17061 K	60,000	68,000	39,000
F 17062 K	75,000	83,000	35,000
F 17063 K	75,000	83,000	23,000
F 17064 K	75,000	83,000	40,000
F 17076 K	72,000	80,000	40,000
F 17077 K	72,000	80,000	29,800
F 17078 K	32,000	40,000	49,200
F 17079 K	50,000	56,010	43,700
F 17080 K	86,000	94,000	45,000
F 17089 K	63,000	71,000	50,800
F 17090 K	60,000	68,000	40,000
F 17091 K	85,000	93,000	63,000
F 17092 K	95,000	103,000	60,000
F 17093 K	42,000	50,000	30,000
F 17094 K	92,000	100,000	27,000
F 17095 K	90,000	98,000	46,000
F 17096 K	84,000	90,000	39,500
F 17097 K	75,000	83,000	48,000
F 17098 K	82,000	90,000	60,000
F 17099 K	62,000	70,000	40,000

Fersa	CROSS REF.		 	
F 17057 K	INA	F-209976		 MERCEDES BENZ (G100-12) ZF (95-75 * 55-42)
F 17058 K	INA	F-209977		 VOLVO (R800) ZF (95-75 * 55-42)
F 17059 K	INA	F-210326.01		 VOLVO (R800) ZF (95-75 * 55-42)
F 17060 K				
F 17061 K	INA	F-202742		 ZF (65-150 C * 85-140 * 85-180 * 95-75 * 95-109 * 165-109)
F 17062 K				 ZF (65-150 C * 95-109 * 165-109 * S6-36)
F 17063 K	INA	F-202961.1		 ZF (65-150 C * 95-109 * 165-109)
F 17064 K				 MERCEDES BENZ (G4-65) ZF (45-120 * 45-120 * 55-90 * 55-92 * 85-140 * 95-140)
F 17076 K	INA	F-204691		 MERCEDES BENZ (G6-80 * G85)
F 17077 K	INA	F-224446		 MERCEDES BENZ (G6-80 * G60-6 * G85)
F 17078 K	INA	F-224448.K-HLA		 MERCEDES BENZ (G6-80 * G60-6 * G85)
F 17079 K	INA	F-225955		 MERCEDES BENZ (G85)
F 17080 K	INA	F-227124.K-HLA		 MERCEDES BENZ (G60-6 * G85)
F17089 K				 MERCEDES BENZ (G85 * G60)
F 17090 K				 VOLVO (R51 * R52 * R52B) MERCEDES BENZ (G6-60 * G3/55-6/8,5)
F 17091 K	INA	F-227349		 VOLVO (VT 2514 B)
F 17092 K	INA	F-227348		 VOLVO (VT 2514 B)
F 17093 K	INA	F-203535		 VOLVO (VT 2514 B)
F 17094 K	INA	F-208939.03		 VOLVO (VT 2514 B)
F 17095 K	INA	F-203030		 VOLVO (VT 2514 B)
F 17096 K	INA	F-227638		 MERCEDES BENZ (G241-16)
F 17097 K	INA	F-227511.06		 MERCEDES BENZ (G211-16 * G241-16)
F 17098 K	INA	F-87934		 ZF (165-160*165-190)
F 17099 K	INA	K 62x70x40 ZW		 ZF (5S111GP * 5S111GP+GV90/1)

09\ Special needle roller bearings Rodamientos de agujas especiales

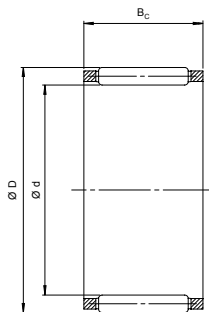
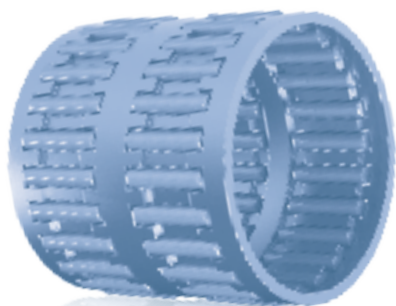

Fersa	d (mm)	D (mm)	B _c (mm)
F 17100 K	80,000	88,000	35,000
F 17101 K	70,000	78,000	43,000
F 17102 K	65,000	73,000	33,000
F 17103 K	57,000	63,000	37,000
F 17104 K	75,000	83,000	33,000
F 17105 K	38,000	46,000	32,000
N F 17106 K	40,000	48,000	20,000
N F 17107 K	60,000	68,000	25,000
N F 17108 K	60,000	68,000	23,000
N F 17109 K	55,000	60,000	30,000
N F 17110 K	73,000	79,000	50,000
N F 17111 K	47,000	53,000	25,000
N F 17112 K	55,000	63,000	20,000
N F 17113 K	65,000	70,000	30,000
N F 17114 K	25,000	33,000	25,000



Wheel end hub units

Unidades de buje







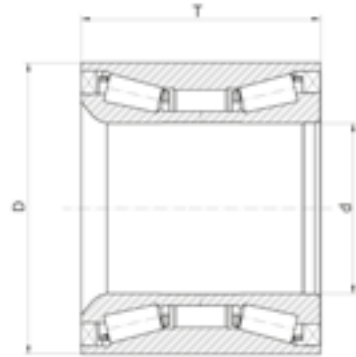
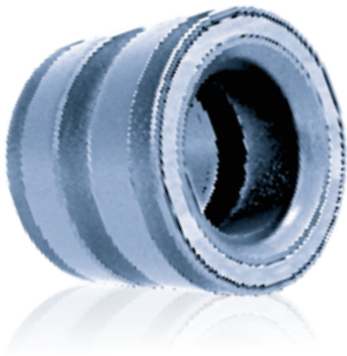

10.1 \	Wheel end hub / Hub de rueda	136
10.2 \	Wheel end kit / Kit de rueda	138
10.3 \	Wheel end module / Modulo de rueda	142
10.4 \	Preset hub assembly / Rodamientos integrales	144

10



10.1 \ Wheel end hub Hub de rueda









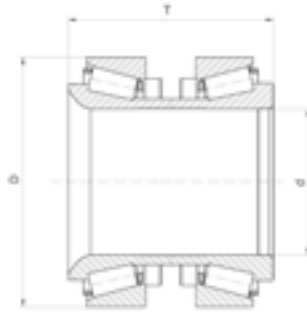









	Fersa	d (mm)	D (mm)	T (mm)	WEIGHT (kg)
	F 15097	68,000 / 68,200	127,000 / 132,000	115,000	6,500
	F 15100	82,000	140,000	115,000	6,450
	F 15120	60,000	108,000	75,000	2,830
	F 15121	55,000	90,000	60,000	1,400
	F 15122	90,000	160,000	125,000	10,240
	F 15125	78,000	130,000	90,000	4,360
	F 15126	82,000	140,000	110,000	6,595
	F 15127	78,000	130,000	90,500	4,345
	F 15300	82,000	140,000	115,000	6,500

Fersa	CROSS REF.		OEM		
F 15097	FAG	201037 / 571762. H195	1413785 / 1439070 / 1443078 / 1476945 / 1724482 / 1868087		SCANIA (93 * 113 * 143 * K3 * K4 * SERIE 3 * SERIE 4)
	SKF TIMKEN	BTH 0018 A / VKBA 5314 SET 1231 / NP 078914			SCANIA (SERIE 3)
F 15100	FAG	805003A.H195	014 981 51 05 / 014 981 93 05 / 014 981 99 05 / 017 981 50 05		MERCEDES BENZ (TE * TL * TZ) GIGANT (D SERIE * G SERIE) SCHMITZ CARGOBULL (SPR * SCS * SKO)
	SKF	BTH 0022 / BTH 0055 / VKBA 5412			
F 15120	FAG KOYO	201050 DU60108 8	015 981 19 05		MERCEDES BENZ (ACTROS MP2 * ATEGO 2 * AXOR 2)
F 15121	FAG SKF	713 6908 40 BTH 1011 / VKBA 3552	7180066		IVECO (Daily I)
F 15122	FAG	201059 / 805012.06. H195	1905487 / 2996882 / 7179751 / 7183074 / 7183075 / 7189050 / 7189648		IVECO (STRALIS * EUROTECH * EUROSTAR)
	SKF TIMKEN	BTH 0053 / VKBA 5397 NP 318274-90UA7 / SET 1242			
F 15125	FAG	803194 A	013 981 22 05 / 013 981 23 05 / 013 981 98 05		MERCEDES BENZ (ATEGO * ATEGO 2 * TOURINO)
F 15126	FAG SKF TIMKEN	805011 C VKBA 5409 SET 1237	2994058 / 7184079 / 7184080		IVECO (EUROCARGO) MERITOR (TC)
F 15127	FAG	805092 C	7182915 / 81.93420.0336 / 81.93420.0379 / 81.93420.6083 / 81.93420.6099 / 8510 3257		IVECO (EUROCARGO) MAN (TGL * TGM * L 2000) VOLVO (FL 6)
					IVECO (EUROPOLIS ELÉCTRICO)
F 15300	FAG	805003CA.H195	81.93420.0344 / 81.93420.0354		MAN (TGL* TGM)

10.2 \ Wheel end kit Kit de rueda









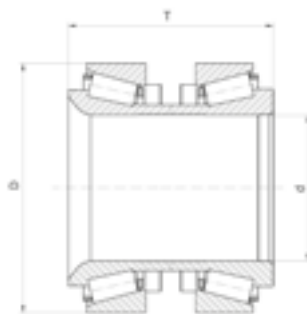

Fersa	d (mm)	D (mm)	T (mm)	WEIGHT (kg)
 F 200004	105,000	160,000	140,000	6,855
 F 200005	110,000	170,000	146,000	8,530
 F 200013	68,000 / 68,200	125,000	115,000	4,45
 F 200014	93,800 / 94,000	148,000	135,000	5,40
 F 200015	57,800 / 58,000	110,000	115,000	3,64
 F 200016	69,800 / 70,000	125,000	114,000	4,86

Fersa	CROSS REF.		OEM		
F 200004	FAG SKF	803750 B VKBA 5408 *	36934200009 / 5031 26457 / 81.93420.0320 / 81.93420.0342		MAN (TGA * TGM * TGS * TGX * M 2000)
	TIMKEN	BT2-0130A SET 1335			BOVA (FUTURA * LEXIO * MAGIG * SINERGY) MAN (LIONS COACH * LIONS CITY * HOCL * NG NL * NÜ * SL * ÜL) MERCEDES (CITARO) NEOPLAN (STARLINER * CITYLINER * EUROLINER) VOLVO (7700 * 8500 * 8700 *)
F 200005	FAG SKF	804162 A VKBA 5416	81.93420.0346 / 81.93420.6098		MAN (TGA * TGM * TGS)
F 200013	FAG SKF	566426.H195 VKBA 5425	20382168 / 20518092 / 20518093 / 20518637 / 20558950 / 20581399 / 20728008 / 20967831 / 21021391 / 2051 8637 / 2096 7831 / 2102 1391 / 3988673 / 3988674 / 3988675 / 74 20 518 637 / 74 20 967 831 / 74 21 021 391		VOLVO (FE * FH * FM * FM 7 * FM 9 * FM 12 * FH 12 * FH 16 * NH 12) RENAULT (Magnum * Premium 2 * Kerax)
	TIMKEN	SET 1312			VOLVO (B6 * 7300 * 7700 * 8500 * 8700 * 9700 * 9900)
F 200014	FAG SKF	566425.H195 VKBA 5423	1075 408 / 20517952 / 20518661 / 20535231 / 20558966 / 20967828 / 21036050 / 2079 2439 / 2079 2440 / 2079 2440 / 3988 774 / 74 20 792 439		VOLVO (FE * FH * FM * FM 7 * FM 9 * FM 12 * FH 12, FH 16 * NH 12 * FL 6 * FL 7 * FL 10 * FL 12 *) RENAULT (Magnum * Premium 2 * Kerax) DAF (XF)
	TIMKEN	SET 1314			VOLVO (B6 * 7300 * 7700 * 8500 * 8700 * 9700 * 9900)
F 200015	FAG SKF	566427.H195 VKBA 5424	20518617 / 20967830 / 20589393 / 20589394 / 21021381 74 20 518 617 / 74 21 021 381		VOLVO (FM 9 * FH 12 * FM 12 * FH 16 * FE * FH * FM) RENAULT (MAGNUM DXI * PREMIUM 2)
	TIMKEN	SET 1311			VOLVO (B6 * 7700 * 8500 * 8700 * 9700 * 9900)
F 200016	FAG	566074.H195	1691621 / 1699327		DAF (65CF * 75CF * 85CF * CF65 * CF65II * CF65IV * CF75 * CF75II * CF75IV * CF85 * CF85II * CF85IV * LF55 * LF55IV * XF95 * XF95II * XF105)

10.2 \ Wheel end kit Kit de rueda



Fersa	d (mm)	D (mm)	T (mm)	WEIGHT (kg)
 F 200017	99,800 / 100,000	148,000	135,000	6,00
 F 200018	82,000	138,000	130,000	6,10
 F 200019	69,800 / 70,000	119,700 / 124,7	110,500	4,50
 F 200025	88,000	138,000	120,000	5,10
 F 200028	120,000	175,030	123,000	7,20
 F 200029	82,000	138,000	110,000	5,80
 F 200031	100,000	148,000	141,000	5,70
 N F 200032	105,000	160,000	140,000	8,120
 N F 200035	78,000	130,000	135,000	5,00





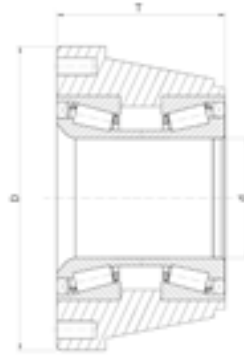



Fersa	CROSS REF.		OEM		
F 200017	FAG	566283.H195	1801594		DAF (65CF * 75CF * 85CF * CF65 * CF65II * CF65IV * CF75 * CF75II * CF75IV * CF85 * CF85II * CF85IV * LF55 * LF55IV * XF95 * XF95II * XF105)
F 200018	FAG	566193.H195	1801593		DAF (CF 75 * 85 CF * CF 85 * XF 95 * XF 105)
F 200019	FAG	566834.H195	1801595		DAF (65CF * 75CF * 85CF * CF65 * CF65II * CF65IV * CF75 * CF75II * CF75IV * CF85 * CF85II * CF85IV * LF55 * LF55IV * XF95 * XF95II * XF105)
F 200025	FAG	570530.H195	03 200 1020 00 / 03 434 3019 00 / 03 434 3020 00 / 03 434 3021 00 / 03 434 3022 00		SAF (B9-19K * B9-19W * B9-22K01 * B9-22W * BA9-22K01 * B19-19K * B19-19W * B19-22K01 * B19-22W * B19-22W-6 * BINL9-22K01 * S11-3720 * S11-4218 * S11-4220 * S7-3015 * S9-3718 * S9-4220 * S111-19 * S111-22 * S19-19 * S19-22 * SIL11-22 * SL11-4220 * SZL11-4220 * SL9-3718 * SL9-4218 * SZL11-4218 * Z)
F 200028	FAG	566830.H195	03 434 3010 00 / 03 434 3012 00 / 04 200 1016 01 / 04 200 1016 02		SAF (SK * SKRS * SKRZ)
F 200029	FAG	569868.H195	03 434 3018 00 / 04 200 1019 00		SAF (SKRB * SKRLB)
F 200031	FAG	566847.H195	03 434 3011 00		SAF (SKRLS * SKRLZ)
N F 200032	SKF TIMKEN FAG	VKBA 5408 * BT2-0130A SET 1335 803750 B	000 350 1349 / 1850970 / 85110616 / 0735 371 966 + 4472 298 146		ZF (AV / AVN-132)
N F 200035	FAG	568879	21102685 / 21363715		VOLVO (FH4 * FM4 * FMX)

10.3 \ Wheel end module Modulo de rueda



Fersa	d (mm)	D (mm)	T (mm)	WEIGHT (kg)
 F 300001	82,000	196,000	113,000	15,300
 F 300003	70,000	195,000	110,000	11,220
 F 300005	70,000	196,000	140,000	13,200
 F 300006	45,000	120,000	84,900	4,000
 F 300007	60,000	168,000	102,000	9,300
 F 300010	60,000	168,000	100,000	9,400













Fersa	CROSS REF.		OEM		
F 300001	FAG SKF	564734.H195 VKBA 5549	1002689 / 1003457 / 100167600 / 100167601 / 3 200 2001 51 / 3 434 3650 00 / 4 200 2001 00 / 4 200 2001 01		SAF (9019 1122) SCHMITZ CARGOBULL (SKI * SPR * SCS * SKO)
F 300003	SNR	HD5001*HUR	81.93420.0344 / 81.93420.0354		RENAULT TRUCKS (KERAX * MAGNUM * MIDIUM * PREMIUN)
F 300005	FAG SKF	801974AE.H195 BTF 0110 / VKBA 5377 / BTF 0021 A	42541578 / 5006207845 / 81.93420.0288 / 81.93420.0330 / 81.93420.0349		MAN (TGA * TGM * TGS * TGX * E 2000 * F 2000 * M 2000)
					IVECO (EUROPOLIS * CITYCLASS) MAN (LIONS COACH * LIONS CITY * LIONS STAR * HOCL * NG * NL * NÜ * NM * UN * RH * SG * SL * SÜ * TOURLINER * ÜL)
F 300006	FAG SKF	713690850 VKBA 3553 / BTFB 328755 D	9381 0034		IVECO (Daily I)
F 300007	FAG FAG TIMKEN	805531 805532.01.H195 SET 1197	20550678 / 5010587029 / 1156414 / 1400061 / 41156414		RENAULT (MIDLUM) DAF (LF 55)
					DAF (SB120)
F 300010	FAG	805532.01.H195	20523899		ALEXANDER DENNIS (Enviro200) VDL (AMBASSADOR ALE 120- 205/ 225 * Citea LLE -120)



























10.4 \ Preset hub assembly

Rodamientos integrales

Fersa	APPLICATION	BRAND	OEM P/N
 F 400001		MERCEDES BENZ	000 350 2335 * 000 350 0535
 F 400002		DAF	1691621 * 1699327 * 1818004
 F 400003		DAF	1657637 * 1812161 * 2019802
 F 400004		DAF	1389061 * 1391617 * 1818003
 F 400006		VOLVO * RENAULT TRUCK	20820420 * 20819822 * 20499882 * 7420820420
 F 400007		VOLVO * RENAULT TRUCK	85105696 * 3988833
 F 400008		VOLVO * RENAULT TRUCK	85107753 * 20535263
			
 F 400009		VOLVO * RENAULT TRUCK	85114470 * 85111791 * 85111448 * 20535202
			
 F 400010		VOLVO * RENAULT TRUCK	85111789 * 85107749
 N F 400011		MERCEDES BENZ	972 330 0125 * 972 330 0225 * 972 330 0325 * 972 330 0425 * 972 330 0525 * 972 330 0625
 F 400013		VOLVO	21024160 * 20534904 * 7421024160 * 7420534904
 F 400014		VOLVO	20518092
 F 400015		SCANIA	2290532 * 2085471

Fersa	POSITION	REMARK
F 400001	Trailer axle / Eje de trailer	Brake disc screws included / Tornillos de disco de freno incluidos
F 400002	Front axle / Eje delantero	Brake disc / Disco de freno
F 400003	Rear axle / Eje trasero	Brake disc / Disco de freno
F 400004	Rear axle / Eje trasero	Brake disc / Disco de freno
F 400006	Rear axle / Eje trasero	Drum brake / Freno de tambor
F 400007	Rear axle / Eje trasero	Brake disc * 27 mm bolts / Disco de freno * pernos 27 mm With ABS/ Con ABS
F 400008	Rear axle / Eje trasero	Brake disc * 25 mm bolts / Disco de freno * pernos 25 mm With ABS/ Con ABS
F 400009	Front axle / Eje delantero	Brake disc / Disco de freno With ABS/ Con ABS
F 400010	Front axle / Eje delantero	Brake disc / Disco de freno With ABS/ Con ABS
N F 400011	Front axle / Eje delantero	Brake disc / Disco de freno With ABS/ Con ABS
F 400013	Front axle / Eje delantero	Drum brake / Freno de tambor
F 400014	Front axle / Eje delantero	Drum brake / Freno de tambor
F 400015	Front axle / Eje delantero	Drum brake / Freno de tambor

10.4 \ Preset hub assembly Rodamientos integrales

Fersa	APPLICATION	BRAND	OEM P/N
 F 400016		SCANIA	1864430 * 2290526
 F 400018		VOLVO	21328181 * 21328177 * 20820402 * 7421328181
 F 400019		VOLVO	1078053 * 20517164 * 85104301
 F 400021		VOLVO	20535244 * 20535245 * 20518053 * 21336855 * 21336856 * 21336857
 F 400022		VOLVO	20476519 * 20518054
 F 400023		DAF	1613331 * 1812160
 N F 400029		MERCEDES BENZ	943 330 08 25 * 943 330 12 25 * 943 330 13 25 * 943 334 00 01
 N F 400030		VOLVO * RENAULT TRUCK	20819826 * 85109244 * 7420819826 * 7485109244
			
 N F 400031		VOLVO * ZF	21062580 * 4472335745
			
 N F 400032		VOLVO * RENAULT TRUCK	21550437 * 7421102556
 N F 400034		MERCEDES BENZ	970 350 0335



Fersa	POSITION	REMARK
F 400016	Front axle / Eje delantero	Brake disc / Disco de freno
F 400018	Rear axle / Eje trasero	Drum brake / Freno de tambor With ABS/ Con ABS
F 400019	Rear axle / Eje trasero	Drum brake / Freno de tambor With ABS/ Con ABS
F 400021	Rear axle / Eje trasero	Drum brake / Freno de tambor With ABS/ Con ABS
F 400022	Rear axle / Eje trasero	Drum brake / Freno de tambor With ABS/ Con ABS
F 400023	Front axle / Eje delantero	Brake disc / Disco de freno
N F 400029	Front axle / Eje delantero	Brake disc / Disco de freno
N F 400030	Rear axle / Eje trasero	Brake disc / Disco de freno With ABS/ Con ABS
N F 400031	Rear axle / Eje trasero	Brake disc / Disco de freno ABS included assembled in the seal / ABS incluido en el retén montado
N F 400032	Front axle / Eje delantero	Brake disc / Disco de freno With ABS/ Con ABS
N F 400034	Rear axle / Eje trasero	Brake disc / Disco de freno



F-Box Rebuild Kit

Kit de reparación F-box

11.1\	Differential F-Box Rebuild Kit / Kit de reparación para diferencial	150
11.2\	Transmission F-Box Rebuild Kit / Kit de reparación para caja de cambios	154

11



11.1 \ Differential F-Box Rebuild Kit

Kit de reparación para diferencial



Fersa	BRAND	MODEL
N FDRK 1A OB	EATON	34RP * 34RS * 34RSB * 38RP * 38RS * 38RSB * RS340 * RS341 * RS380 * RS381 * RS386 * RS400 * RS401 * RS402 * RS403 * RS406 * RS451 * RS3416 * RS4026 * 17100 * 17101 * 17120 * 17121 * 17123 * 18100 * 18101 * 18103 * 18120 * 18121 * 18123 * 21121
N FDRK 23 OB	EATON	30R3*30RP*30RS*30RT*1618*1619*6802*6803*16220*16320*16321*16500*16501*16800*16802*16803
N FDRK 23D OB	EATON	16120*16123*16220*16244*16247*16344*19050-P*19050-T
N FDRK 192RB OB	DANA	J175-S * J190-S * J210-S * J220-S * J230-S * J210-SB * J340-S * J380-S * J400-S
N FDRK 196 OB	EATON	DS341(P) * DS381(P) * DS401-P * DA402(P) * DS402(P) * DS403(P) * DS451-P
N FDRK 200F OB	INTERNATIONAL HARVESTER/ NAVISTAR	RA472
N FDRK 201F OB	INTERNATIONAL HARVESTER/ NAVISTAR	RA474
N FDRK 200FA OB	DANA	J340-S * J380-S * J400-S
N FDRK 201R OB	DANA	W230-S * W440-S * W460-S
N FDRK 201FA OB	DANA	W440-S * W460-S
N FDRK 205 OB	MACK	SW29*SW30*SW31*CRD93*CRDLP93*CRD113
N FDRK 206 OB	MACK	SWD32*CRDLP92*CRDLP92*CRDLP92*CRDPC112
N FDRK 217R OB	MERITOR	RS-16-141 * RS-17-141 * RS-17-144 * RS-17-145 * RS-19-144 * RS-19-145 * RS-21-145 * RT-34-144 * RT-34-145 * RT-38-144 * RT-40-140 * RT-40-145 * RT-44-145
N FDRK 222F OB	EATON	DS341(P) * DA402(P) * DS402(P) * DS403(P) * DS451-P
N FDRK 222R OB	EATON	RS341 * RA402 * RS402 * RS403 * RS451
N FDRK 223F OB	DANA	N340-S * N400-I
N FDRK 223R OB	DANA	N175 * N190 * N340-S * N400-I
N FDRK 339B OB	DANA	Dana 44
N FDRK 404 F OB	EATON	DST40(P) * DST41(P) * DA344 * DS344 * DA404(P) * DS404(P) * DA405(P) * DS405(P) * DA454(P) * DS454(P)
N FDRK 404FA OB	EATON	DST40(P)*DST41(P)*DS344*DA404(P)*DS404(P)*DA405(P)*DS405(P)
N FDRK 404 R OB	EATON	RA344 * RS344 * RA404 * RS404 * RA405 * RS405 * RA454 * RS454 * 17060-S * 19060-S * 21060-S * 22060-S
N FDRK 405F OB	EATON	DDT40-P * DDT41(P) * DD404(P) * DD405(P) * DD454(P)
N FDRK 405FA OB	EATON	DDT40-P*DDT41(P)*DD404(P)*DD405(P)

Fersa	BRAND	MODEL
N FDRK 405R OB	EATON	RD404 * RD405 * RD454 * 19060-D * 21060-D
N FDRK 412 OB	EATON	RS341 * RA402 * RS402 * RS403 * RS451 * 22120 * 22121
N FDRK 414 OB	DANA	S135-S * S150-S
N FDRK 427 OB	EATON	DSH40(P)*DSP40(P)*DSP41(P)*DDH44(P)
N FDRK 427A OB	DANA / EATON	D40-145S*D40-145X DSH40(P)*DSP40(P)*DSP41(P)
N FDRK 433 OB	EATON	DS461-P * DS462-P * DS463-P * DS521-P * DS581-P * DS601(P) * DS651-P
N FDRK 436 OB	DANA	D40-170D * D40-170DP * D50-170D * D50-170DP * D46-170D * D46-170DP
N FDRK 437 OB	DANA	D52-190DP * D52-190P * D60-190DP * D60-190P * D46-590DH * PD46-590HP * D52-590DP * D52-590P * D60-590DP * D60-590P * D70-590DP * D70-590P
N FDRK 438 OB	DANA	S21-170 * S23-170 * S25-170 * R50-170 * R40-170 * R46-170
N FDRK 439 OB	DANA	S21-170 * S23-170 * S25-170 * R50-170 * R40-170 * R46-170
N FDRK 441 OB	DANA	S21-190 * S21-190D * S23-190 * S23-190D * S26-190 * S26-190D * S30-190 * S30-190D * R52-190 * R52-190D * R60-190 * R60-190D
N FDRK 442 OB	DANA	D40-170 * D40-170P * D46-170 * D46-170P * D46-170H * D46-146HP * D50-170 * D50-170P
N FDRK 443 OB	DANA	S21-170D * S23-170D * S25-170D * S21-190 * S21-190D * S23-190 * S23-190D * S26-190 * S26-190D * S30-190 * S30-190D * R50-170D * R40-170D * R46-170D * R52-190 * R52-190D * R60-190 * R60-190D
N FDRK 444 OB	DANA	S21-170D * S23-170D * S25-170D * R50-170D * R40-170D * R46-170D
N FDRK 650F OB	ALLIANCE / DETROIT / FREIGHTLINER	ART34-4 * ART40-4 * ART44-4
N FDRK 650R OB	ALLIANCE / DETROIT / FREIGHTLINER	ARS17.5-4*ARS19-4*ARS20-4*ARS23-4*ART34-4 * ART40-4 * ART44-4
N FDRK 651 OB	ALLIANCE / DETROIT / FREIGHTLINER	ARS13-2 * ARS15-2 * ARS17.5-2 * ARS19-2 * ARS21-2
N FDRK 1346	DAF	1346
N FDRK 1347	DAF	1347 * 1347S
N FDRK 1922 OB	MERITOR	SSHD* STHD* SUHD* FDS-1807* FDS-1808* FDS-2101* FDS-2102
N FDRK 1923 OB	MERITOR	SSHD* STHD* SUHD
N FDRK 4100 OB	MERITOR	SSHD* STHD* SUHD (Carrier 3200-R-1162)
N FDRK 4356 OB	MERITOR	RT-40-140

11.1 \ Differential F-Box Rebuild Kit

Kit de reparación para diferencial



Fersa	BRAND	MODEL
N FDRK 4375 OB	MERITOR	RS-23-240
N FDRK 4390 OB	MERITOR	RS-17-144 * RS-19-144 * RS-21-145 * RT-34-144 * RT-38-144 * RT-40-145 * RT-44-145
N FDRK 4396 OB	MERITOR	RT-34-144 * RT-34-145 * RT-38-144 * RT-40-145 * RT-44-145 * MT-40-143
N FDRK 4400 OB	MERITOR	RS-17-144* RS-17-145* RS-19-144* RS-19-145* RS-21-145* RS-34-144* RT-34-145* RT-40-140* RT-40-145* RT-44-145 (Carrier 3200-L-1676* 3200-Q-1785* 3200-S-1865* 3200-A-1873* 3200-M-1885* 3200-U-1919)
N FDRK 4406 OB	MERITOR	RT-34-144 * RT-38-144 * MT-40-143 * RT-40-145 * RT-44-145
N FDRK 4422 OB	MERITOR	RT-40-60 * RT-46-160 * RT-46-164 * RT-50-160 * RT-50-164 * RT-52-160 * RT-52-164
N FDRK 4423 OB	MERITOR	160* 161 * 164 Series Tandem Axles
N FDRK 4426 OB	MERITOR	160* 161 * 164 Series Single and Tandem Axles
N FDRK 4428 OB	MERITOR	160* 161 * 164 Series Single and Tandem Axles
N FDRK 4435 OB	MERITOR	RS-23-180 * RS-23-185 * RS-23-186 * RS-30-180 * RS-30-185 * RT-48-180 * RS-48-185 * RT-52-180 * RT-52-185 * RT-58-180
N FDRK CRAFTER	VOLKSWAGEN	Crafter
N FDRK EV91	VOLVO	EV91*RS1356SV
N FDRK HL6*	MERCEDES BENZ	HL6
N FDRK HL8	MERCEDES BENZ	HL8
N FDRK MAN HY1175	MAN	MAN HY1175*1350 (Ø425 mm)
N FDRK MS17X	MERITOR / VOLVO	MS17X * RSS1344C
N FDRK MS140 OB	MERITOR	MS140
N FDRK MS185 OB	MERITOR	MS185
N FDRK MS240 OB	MERITOR	MS240
N FDRK R660	SCANIA	R660
N FDRK R780	SCANIA	R780
N FDRK RB660	SCANIA	RB660
N FDRK RB662	SCANIA	RB662
N FDRK RBP835	SCANIA	RBP835
N FDRK RP835	SCANIA	RP835
N FDRK RTS2370 INTERM	VOLVO	RTS2370A (Intermediate) * RTS2370B (Intermediate)
N FDRK RTS2370 REAR	VOLVO	RTS2370A (Rear) * RTS2370B (Rear)
N FDRK U177 - IVECO	MERITOR	U177
N FDRK U177 - VOLVO	MERITOR / VOLVO	U177 * RS1228B * RSS1344B

*Complete Kit (seal included and all components for the rebuild) / Kit completo (incluye retenes y todos los componentes necesarios para la reparación)

11.2 \ Transmission F-Box Rebuild Kit

Kit de reparación para caja de cambios



Fersa	BRAND	MODEL
N FTRK 192 OB	SPICER/TTC TRANSMISSIONS	1352 * 1362 * 1364 * 1452 * 1453 * 1463 * SST6
N FTRK 222 OB	SPICER/TTC TRANSMISSIONS	ES066-7B * ES52-7 * ES56-7 * ES65-7 * ES066-7
N FTRK 510 OB	VOLVO	AT2412C * AT2412D * ATO2412C * ATO2412D - Early Planet (70mm O/S Brg.)
N FTRK 510A OB	VOLVO	AT2412C * AT2412D * ATO2412C * ATO2612D - Late Planet (70mm O/S Brg.)
N FTRK 511 OB	VOLVO	AT2512C * AT2612D * AT2812C * AT2812D * ATO3112C * ATO3112D Early Planet (70mm O/S Brg.)
N FTRK 511A OB	VOLVO	AT2512C * AT2612D * AT2812C * AT2812D * ATO3112C * ATO3112D Late Planet (80mm O/S Brg.)
N FTRK 2286 OB	EATON	RTLO-14713A * RTLOF-14713A
N FTRK 2288 OB	EATON	RTLO-14718B * RTLO-16718B * RTLOF-14718B * RTLOF-16718B
N FTRK 2865 OB	EATON	RTLO-18718B * RTLO-18718B-T2 * RTLOF-18718B * RTLOF-18718B-T2
N FTRK 2924 OB	EATON	10 Speed Models
N FTRK 3132 OB	EATON	10 Speed Models
N FTRK 3233 OB	EATON	RTO-14908LL * RTO-16908LL * RTOF-14908LL * RTOF-16908LL * RTO-14915 * RTO-16915 * RTOF-14915 * RTOF-16915
N FTRK 3256 OB	EATON	RTO-11908LL * RTO-14908LL * RTOF-11908LL * RTOF-14908LL * RT-14915 * RTF-14915 * RTO-14915 * RTOF-14915
N FTRK 3340 OB	EATON/FULLER	RTLO-14918B (w/ Forced Lubrication)*RTLO-16918B* RTLO-16918B-T2*RTLO-18918B*RTLO-18918B-T2* RTLO-20918B*RTLO-20918B-T2*RTLOF-14918B (w/ Forced Lubrication)*RTLOF-16918B* RTLOF-16918B-T2*RTLOF-18918B*RTLOF-18918B-T2* RTLOF-20918B*RTLOF-20918B-T2
N FTRK 3343 OB	EATON	RTLO-12913A * RTLO-14913A * RTLO-16913A * RTLO-18913A * RTLOF-12913A * RTLOF-14913A * RTLOF-16913A * RTLOF-18913A
N FTRK 3423 OB	EATON/FULLER	FS-5406A*FS-5406N*FS-6406A*FS-6406N*FSB-5406B* FSO-6406A*FSO-8406A
N FTRK 3440 OB	EATON/FULLER	F-5405B-DM3*F-5505B-DM3*F-6405B-DM3*F-6505B-DM3* FO-5406B-DM3*FO-5506B-DM3*FO-6406A-ASX* FO-6406B-DM3*FO-6506B-DMW*FO-8406A-ASX
N FTRK 3462 OB	EATON	RTLO-22918B * RTLOF-22918B
N FTRK 7052 OB	EATON	FS-5306A*FS-6306A
N FTRK 101 432 1X OB	SPICER/TTC TRANSMISSIONS	CM60 * CM5252 * CM5952 * ES42-5 * ES43-5

12

Passenger car wheel bearing kits

Kits de rueda para turismos

12

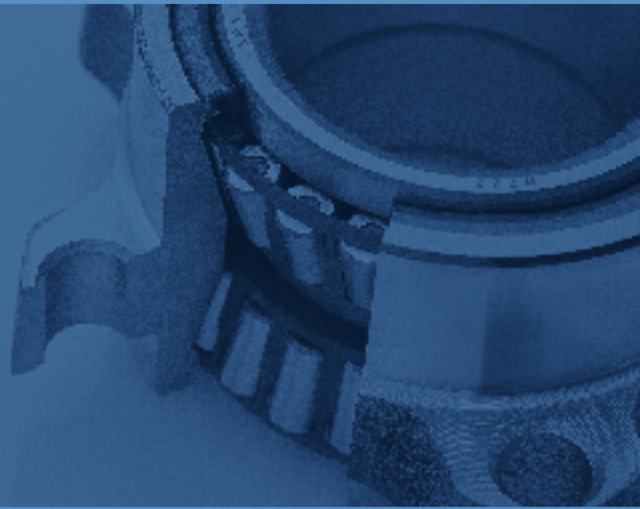

12\ Passenger car wheel bearing kits

Kits de rueda para turismos



KA



KB



KC



KD

Fersa				
KA 001	LM 11749/10	L 45449/10	ALFA ROMEO (33 * ALFASUD)	▪
KA 002	LM 11749/10	L 44649/10	ALFA ROMEO (ALFETTA), TOYOTA (CARINA * CELICA * COROLLA * STARLET)	▪
KA 003	LM 11949/10	L 45449/10	ALFA ROMEO (75 * 90 * ALFETTA * GIULIETTA * GTV)	▪
KA 004	LM 11949/10	LM 67048/10	ALFA ROMEO (6 * 75 * RZ * SZ)	▪
KA 005	LM 11949/10	L 45449/10	AUDI (A4 * A6 * COUPE * 80 * CABRIO * 90 * 100), SEAT (INCA), VW (CADDY)	▪
KA 006	REPLACED BY KA 069 / SUSTITUIDO POR EL KA 069			
KA 007	LM 11749/10	L 45449/10	DAEWOO (ESPERO * LANOS * NEXIA * NUBIRA), OPEL(ASCONA * CORSA * KADETT * MANTA * REKORD * TGRA * VECTRA)	▪
KB 008	F 15041		CITROËN (AX * SAXO * VISA * XSARA * ZX), PEUGEOT (106 * 205 * 306 * 309)	▪
KA 009	32010 XF	32010 XF	CITROËN (C25), FIAT (DUCATO), PEUGEOT (J5)	▪
KA 010	32008 XF	32006 XF	CITROËN (C25), FIAT (DUCATO), PEUGEOT (J5)	▪
KB 011	F 15166		CITROËN (C35), FIAT (242).	▪
KB 012	F 15166		CITROËN (C35), FIAT (242).	▪
KA 013	32008 XF	32006 XF	CITROËN (JUMPER), FIAT (DUCATO), PEUGEOT (BOXER)	▪
KA 014	LM 11749/10	L 44649/10	FORD (ESCORT * FIESTA)	▪
KA 015	F 15036	F 15036	FORD (ESCORT * FIESTA * ORION)	▪
KA 016	REPLACED BY KA 075 / SUSTITUIDO POR EL KA 075			
KA 017	LM 11749/10	L 44649/10	FORD (CORTINA * ESCORT * TAUNUS)	▪
KA 018	F 15036	F 15036	FORD (SIERRA)	▪
KA 019	F 15036	F 15036	FORD (ESCORT * FIESTA)	▪
KA 020	F 15040	F 15040	FORD (ESCORT * FIESTA * ORION)	▪
KA 021	F 15029	F 15029	FORD (ESCORT * FIESTA * ORION)	▪
KA 022	F 15055	F 15055	HYUNDAI (ACCENT * ATOS * LANTRA * PONY), MITSUBISHI (COLT * CORIA * LANCER * MIRAGE * SPACEWAGON * TREDIA)	▪
KA 023	M 12649/10	LM 48548/10	HYUNDAI (H-100 * H-1 * STAREX), MITSUBISHI (L-200 * L-300 * L-400)	▪
KA 024	32008 XF	32008 XF	LADA (NIVA)	▪
KA 025	LM 11949/10	LM 67048/10	MERCEDES (SL * 8)	▪
KA 026	LM 300849/11	LM 503349 A/10	MERCEDES (SEDAN * KOMBI * COUPE * SL * CLASE S)	▪
KA 027	M 12649/10	LM 48548/10	MERCEDES (SEDAN * KOMBI * COUPE * SL * CLASE S * T-1)	▪
KA 028	LM 11949/10	LM 67048/10	MERCEDES (190 * SEDAN * KOMBI * COUPE * SL * CLASE E)	▪
KA 029	M 12649/10	LM 48548/10	MERCEDES (SEDAN * KOMBI * COUPE * SL * CLASE S)	▪



KF

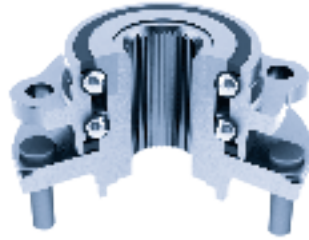

KV

- KA Single row tapered roller bearings / Rodamientos de rodillos cónicos
- KB Double row tapered roller bearings / Rodamientos cónicos de doble hilera
- KC Ball bearings / Rodamientos de bolas
- KD Double row ball bearings / Rodamientos de bolas de doble hilera
- KF Double row angular contact ball bearings / Rodamientos de bolas de doble hilera de contacto angular
- KV 2nd and 3rd generation wheel hub units / Rodamientos de rueda con brida de 2ª y 3ª generación

Fersa				
KA 030	LM 11749/10	LM 67048/10	MERCEDES (190)	▪
KA 031	32009 XF	32009 XF	MERCEDES-BENZ MB	▪
KA 032	30306 F	30209 F	MERCEDES (100)	▪
KA 033	LM 503349 A /10	32009 XF	MERCEDES (100)	▪
KA 034	LM 11949/10	L 44649/10	NISSAN (MICRA)	▪
KA 035	LM 501349/10	30209 F	NISSAN (PATROL)	▪
KA 036	LM 11949/10	LM 67048/10	NISSAN (280 * LAUREL * SILVIA)	▪
KA 037	32010 XF	32010 XF	NISSAN (L35)	▪
KA 038	LM 11749/10	L 45449/10	DAEWOO (ESPERO * LANOS * NEXIA * NUBIRA), OPEL (ASCONA * CORSA * KADETT * MANTA * REKORD * TIGRA * VECTRA)	▪
KA 039	LM 11949/10	LM 67048/10	OPEL (COMMODORE * MONZA * KADETT * REKORD * SENATOR)	▪
KA 040	LM 11749/10	L 44649/10	OPEL (ASCONA * KADETT * MANTA * OLIMPIA * REKORD)	▪
KA 041	32005 XR	320/32 XF	PEUGEOT (504 * 505 * 604), TALBOT (TAGORA)	▪
KA 042	F 15063	30203 F	RENAULT (4 * 5 * 6 * 8 * 10)	▪
KA 043	30204 F	30205 F	RENAULT (4 * 5 * 6 * 12 * 15 * 16 * 17)	▪
KA 044	32004 XF	32005 XR	RENAULT (FUEGO * 18 * 16 * 15 * 14 * 12 * 6 * 5 * 4)	▪
KB 045	F 15041		RENAULT (SUPER 5 * 9 * 11 * 19)	▪
KB 046	F 15042		RENAULT (EXPRESS * 21)	▪
KB 047	F 15043		NISSAN (KUBISTAR), RENAULT (KANGOO * LAGUNA * EXPRESS)	▪
KB 048	F 15044		RENAULT (CLIO * EXPRESS * THALIA * TWINGO * SUPER 5 * 9 * 11 * 19)	▪
KA 049	30205 F	32007 XF	RENAULT (TRAFFIC)	▪
KA 050	LM 603049/11	LM 603049/11	LAND ROVER (90 * 100 * 110 * RANGE ROVER)	▪
KA 051	11162/300	359 A/354 X	LAND ROVER (88 * 109)	▪
KA 052	LM 603049/11	LM 603049/11	LAND ROVER	▪
KA 053	LM 603049/11	LM 603049/11	LAND ROVER (DEFFENDER)	▪
KA 054	30204 F	LM 67048/10	SKODA (FAVORIT)	▪
KA 055	LM 11949/10	15579 X/20	FIAT (124 * 1200 * 1600)	▪
KA 056	LM 11949/10	LM 67048/10	FIAT (ARGENTA * 125 * 132)	▪
KA 057	LM 11949/10	J 15585/20	FIAT (131), SEAT(131)	▪
KA 058	32006 XF	32008 XF	CITROËN (C25)	▪
KA 059	LM 11749/10	L 44649/10	TALBOT (1307 * 1510)	▪
KA 060	30204 F	L 44649/10	TALBOT (1100 * 1307 1200)	▪
KA 061	F 15003	F 15003	SUZUKI (SAMURA) * SJ 413)	▪

12\ Passenger car wheel bearing kits

Kits de rueda para turismos



KA



KB



KC



KD

Fersa				
KB 062	F 15015		SUZUKI (VITARA * X-90)	▪
KA 063	30204 F	L 44649/10	TALBOT (SIMCA, RANCHO, 1307)	▪
KA 064	LM 11949/10	LM 67048/10	TALBOT (180)	▪
KA 065	LM 11749/10	L 45449/10	DAIHATSU (CHARMANT), TOYOTA (CELICA * CARINA)	▪
KA 066	LM 11949/10	LM 67048/10	TOYOTA (CARINA * CELICA * COROLLA)	▪
KA 067	LM 11949/10	LM 67048/10	TOYOTA (CELICA)	▪
KA 068	LM 11749/10	L 44649/10	VOLVO (66 * 340-360)	▪
KA 069	LM 11749/10	L 45449/10	ALFA ROMEO (50 * 60 * 75 * 80); AUDI (50 * 60 * 75 * 80 * 100 * COUPE), PORSCHE (924), SEAT (AROSA * CORDOBA * IBIZA * TOLEDO), SKODA (FAVORIT * FELICIA), WV (CADDY * CORRADO * DERBI * GOLF * JETTA * KAEFFER * PASSAT * POLO * SANTANA * SCIROCCO * VENTO)	▪
KA 070	M 12649/10	LM 48548/10	TOYOTA (HYLUX * 4 RUNNER * HIACE I)	▪
KA 071	L 45449/10	LM 300849/11	WV (LT 28-35)	▪
KA 072	32010 XF	32010 XF	WV (LT 28-35)	▪
KA 073	32004 XF	32005 XR	CITROËN (VISA * LNA)	▪
KA 074	F 15135	F 15135	FORD (FIESTA)	▪
KA 075	LM 11749/10	L 45449/10	FORD (CAPRI * CONSUL * ESCORT * GRANADA * ORION))	▪
KA 076	F 15036	F 15036	FORD (SIERRA)	▪
KA 077	LM 11949/10	L 45449/10	ALFA ROMEO (ARNA), NISSAN (CHERRY)	▪
KB 078	F 15041		CITROËN (SAXO), PEUGEOT (106)	▪
KA 079	32010 XF	32010 XF	CITROËN (C25)	▪
KA 080	32206 F	33108 F	CITROËN (JUMPER)	▪
KA 081	F 15036	F 15036	FORD (SIERRA)	▪
KA 082	F 15036	F 15036	FORD (SIERRA)	▪
KA 083	LM 11949/10	LM 67048/10	FORD (ESCORT RANCHERA)	▪
KA 084	18790/20	387 A/382 A	FORD (TRANSIT)	▪
KA 085	LM 11949/10	32007 XR	FORD (TRANSIT)	▪
KA 086	LM 11749/10	L 44649/10	HYUNDAI (PONY), MITSUBISHI (COLT * CELESTE)	▪
KA 087	LM 11749/10	L 45449/10	MERCEDES (CLASE G)	▪
KA 088	30204 F	30205 F	PEUGEOT (304 * 204)	▪
KA 089	30204 F	30205 F	PEUGEOT (304 * 204 * 305)	▪
KB 090	F 15050		RENAULT (CLIO * MEGANE * SUPER 5 * 9 * 11 * 19)	▪
KA 091	32005 XR	320/32 XF	RENAULT (TRAFFIC)	▪
KF 092	F 16046		ALFA ROMEO (75 * 90 * GTV)	▪



KF

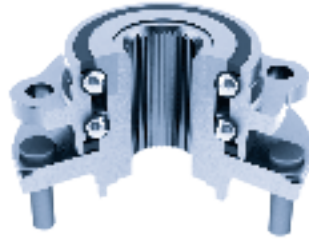

KV

- KA Single row tapered roller bearings / Rodamientos de rodillos cónicos
- KB Double row tapered roller bearings / Rodamientos cónicos de doble hilera
- KC Ball bearings / Rodamientos de bolas
- KD Double row ball bearings / Rodamientos de bolas de doble hilera
- KF Double row angular contact ball bearings / Rodamientos de bolas de doble hilera de contacto angular
- KV 2nd and 3rd generation wheel hub units / Rodamientos de rueda con brida de 2ª y 3ª generación

Fersa			
KF 093	REPLACED BY KF 092 / SUSTITUIDO POR EL KF 092		
KF 094	F 16031		ALFA ROMEO (33)
KF 095	F 16035		AUDI (80 * COUPE * 90), WV (GOLF * JETTA * PASSAT * SANTANA)
KF 096	F 16038		AUDI (A4 * A6 * 80 * CABRIO, COUPE * 90), WV (PASSAT * SANTANA) SKODA (SUPERB)
P KV 097	REPLACED BY KV 194 / SUSTITUIDO POR EL KV 194		
KF 098	F 16054		AUDI (A4 * A6 * V8 * A8 * COUPE * 80 * 90)
KF 099	F 16041		HONDA (ACCORD), MG (MG-ZR), ROVER (25 * 200 * 400 * CABRIO * COUPE)
KV 100	F 16008		HONDA (CIVIC * CRX * LOGO), ROVER (200)
KF 101	F 16052		MG (ZS), ROVER (45 * 400)
KF 102	F 16053		HONDA (CIVIC * CRX * HR-V)
KV 103	F 16015		BMW (SERIE 3 * СЕРИЯ 3)
KF 104	F 16036		BMW (316 * 318 * 320 * 324 * 325)
A KV 105	F 16060		BMW (518 * 520 * 525 * 524 * 530 * 535 * 750 * 850)
KF 106	F 16046		BMW (316 * 318 * 320 * 324 * 325 * M3 * TOURING * CABRIO)
KF 107	F 16032		BMW (518 * 520 * 525 * 524 * 530 * 535)
P KV 108	F 16033		BMW (518 * 520 * 525 * 524 * 530 * 535 * 730 * 735 * 740 * 750 * 840 * 850)
KF 109	F 16036		BMW (316 * 318 * 320 * 324 * 325 * M3 * TOURING * CABRIO)
KF 110	F 16046		BMW (316 * 318 * 320 * 324 * 325 * M3 * TOURING * CABRIO * Z1 * Z4)
KF 111	F 16022		CITROËN (AX * SAXO), PEUGEOT (106)
KF 112	F 16004		CITROËN (AX * SAXO), PEUGEOT (106)
KF 113	F 16056		CITROËN (EVASION * JUMPY), FIAT (SCUDO * ULYSSE), LANCIA (ZETA), PEUGEOT (806 * EXPERT)
KV 114	F 16016		CITROËN (BERLINGO * XANTIA), PEUGEOT (406 * PARTNER)
KF 115	F 16036		FORD (ESCORT * FIESTA * ORION * PUMA)
KF 116	F 16055		FORD (COUGAR * MONDEO)
KD 117	F 18009		FORD (TRANSIT)
KD 118	F 18009		FORD (MONDEO)
KF 119	F 16091		MITSUBISHI (CARISMA * COLT * LANCER * MONTERO)
KV 120	F 16006		MITSUBISHI (LANCER, COLT, CARISMA. MONTERO)
KF 121	F 16090		MITSUBISHI (GALANT * ECLIPSE * SPACE WAGON * SPACE RUNNER)

12\ Passenger car wheel bearing kits

Kits de rueda para turismos



KA



KB



KC



KD

Fersa				
KV 122	F 16014		MITSUBISHI (SPACE-. WAGON)	▪
KV 123	F 16014		MITSUBISHI (SPACE-. WAGON)	▪
KF 124	F 16059		MERCEDES (124 * 190 * CLASE C * CLK * CLASE E * SL * SLK)	▪
KB 125	F 15167		MERCEDES (KOMBI * CLASE E)	▪
KA 126	U 497/U 460 L + COLLAR		MERCEDES (CLASE G * HENSCHEL * T1)	▪
KF 127	F 16059		MERCEDES (CLASE V * VITO)	▪
KF 128	F 16081		NISSAN (PRIMERA * PRAIRIE * MAXIMA)	▪
KF 129	F 16058		NISSAN (SUNNY)	▪
KF 130	F 16034		NISSAN (SUNNY * ALMERA)	▪
KA 131	32209 F	32209 F	NISSAN (PATROL)	▪
KC 132			NISSAN (BLUEBIRD * VANETTE * LAUREL * SILVIA)	▪
KF 133	F 16019		DAEWOO (NEXIA * CIELO)	▪
KF 134	F 16036		DAEWOO (NEXIA * CIELO * ESPERO)	▪
P KV 135	F 16028		OPEL (OMEGA * SENATOR) VAUXHALL (CARLTON * SENATOR * OMEGA)	▪
KF 136	F 16032		OPEL (CALIBRA * OMEGA * SENATOR * VECTRA)	▪
KF 137	F 16020		OPEL (ASTRA * COMBO * CORSA * KADETT * TIGRA * VECTRA)	▪
KF 138	F 16037		OPEL (ASTRA * CALIBRA * OMEGA * VECTRA)	▪
KF 139	F 16042		PEUGEOT (204 * 304 * 305)	▪
KF 140	F 16049		PEUGEOT (504 * 505)	▪
KF 141	F 16050		PEUGEOT (504 * 505)	▪
KF 142	F 16026		CITROËN (AX * C15)	▪
KF 143	F 16048		CITROËN (BERLINGO)	▪
KV 144	F 16017		CITROËN (BX)	▪
KF 145	F 16029		CITROËN (C2 * C3 * SAXO * XSARA), PEUGEOT (106 * 206 * 306)	▪
KC 146			RENAULT (4 * 6)	▪
KC 147			RENAULT (5 * 12)	▪
KC 148			RENAULT (4 * 5)	▪
KC 149			DACIA (1300), RENAULT (12 * 15 * 18)	▪
KF 150	F 16025		RENAULT (14)	▪
KF 151	F 16021		CITROËN (XANTIA)	▪
KV 152	F 16044		RENAULT (SPACE)	▪
KF 153	F 16051		RENAULT (20 * 30 * TRAFFIC)	▪



KF

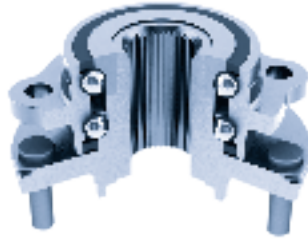

KV

- KA Single row tapered roller bearings / Rodamientos de rodillos cónicos
- KB Double row tapered roller bearings / Rodamientos cónicos de doble hilera
- KC Ball bearings / Rodamientos de bolas
- KD Double row ball bearings / Rodamientos de bolas de doble hilera
- KF Double row angular contact ball bearings / Rodamientos de bolas de doble hilera de contacto angular
- KV 2nd and 3rd generation wheel hub units / Rodamientos de rueda con brida de 2ª y 3ª generación

Fersa				
KV 154	F 16005		RENAULT (SPACE * LAGUNA * FUEGO)	▪
KF 155	F 16030		RENAULT (LAGUNA I * MEGANIE * SCENIC * SAFRANE)	▪
P KV 156	F 16061		RENAULT (SPACE)	▪
P KV 157	F 16007		RENAULT (21)	▪
KF 158	F 16031		DACIA (LOGAN), RENAULT (CLIO * SPACE * KANGOO * LAGUNA * MEGANE * SCENIC * EXPRESS * THALIA * 19 * 21)	▪
KF 159	F 16024		SKODA (FAVORIT * FELICIA), WV (CADDY)	▪
KF 160	F 16002		FIAT (DUNA * FIORINO)	▪
KF 161	F 16001		FIAT (UNO)	▪
KV 162	F 16062		FIAT (DUNA * REGATA * FIORINO)	▪
KV 163	F 16003		FIAT (PANDA)	▪
KV 164	F 16010		ALFA ROMEO (145 * 146)	▪
KF 165	F 16027		FIAT (LINEA * TEMPRA)	▪
KF 166	F 16031		ALFA ROMEO (145)	▪
KF 167	F 16031		FIAT (DOBLO * FIORINO)	▪
KF 168	F 16027		FIAT (LINEA * TEMPRA), LANCIA (DELTHA)	▪
KA 169	30305 F	32208 F	IVECO (DAILY)	▪
KA 170	32011 XF	32011 XF	IVECO (DAILY)	▪
KA 171	18690/18620	368 A/362 A	IVECO (DAILY)	▪
KF 172	F 16043		TALBOT (HORIZON * 1300)	▪
KF 173	F 16009		TOYOTA (CAMRY * CARINA)	▪
KC 174			TOYOTA (LITEACE)	▪
KF 175	F 16024		VOLVO (440 * 460)	▪
KF 176	F 16024		VOLVO (440)	▪
KV 177	F 16012		VOLVO (440)	▪
P KV 178	F 16013		VOLVO (440)	▪
KF 179	F 16019		WV (CADDY * GOLF)	▪
KF 180	F 16018		AUDI (50), WV (DERBY)	▪
KF 181	F 16023		SEAT (AROSA), WV (GOLF)	▪
KF 182	F 16039		SEAT (CORDOBA)	▪
KF 183	F 16039		SEAT (TOLEDO), WV (CORRADO * GOLF * PASSAT)	▪
KF 184	F 16040		AUDI (A3 * TT), SEAT (LEON * TOLEDO) SKODA (OCTAVIA * ROOMSTER), WV (BORA * GOLF * NEW BEETTLÉ)	▪
KF 185	F 16035		AUDI (COUPE * 80 * 90), WV (GOLF * JETTA * PASSAT * SANTANA)	▪

12\ Passenger car wheel bearing kits

Kits de rueda para turismos



KA



KB



KC



KD

Fersa				
KA 186	30208 F		MITSUBISHI (L-200 * L-300 * MONTERO)	▪
KA 187	L 45449/10	L 45449/10	MITSUBISHI (COLT * LANCER * MIRAGE)	▪
KC 188			MITSUBISHI (COLT * CELESTE * GALANT * SAPPORO)	▪
KA 189	LM 12749/10	L 68149/11	MERCEDES (CLASE C * CLK * SEDAN * CABRIO * CLASE E * SLK)	▪
KA 190	LM 102949/10	LM 102949/10	HYUNDAI (GALLOPER), MITSUBISHI (L-200 * L-300 * MONTERO)	▪
KB 191	F 15067		FORD (FIESTA * FOCUS * FUSION), MAZDA (2)	▪
KB 192	F 15044		RENAULT (CLIO * EXPRESS * THALIA * TWINGO * SUPER 5 * 9 * 11 * 19)	▪
KB 193	F 15041		DACIA (LOGAN), NISSAN (MICRA * NOTE), RENAULT (CLIO * LOGAN * MEGANE * MODUS * THALIA * TWINGO * 19 * CHAMADE)	▪
P KV 194	F 16065		AUDI (A3 * TT), SEAT (LEON * TOLEDO) SKODA (OCTAVIA * ROOMSTER), VW (BORA * GOLF * NEW BEETLE)	▪
KF 195	F 16066		RENAULT (LAGUNA * MEGANE * SAFRANE)	▪
KV 196	F 16067		OPEL (ASTRA * ZAFIRA)	▪
KF 197	F 16068		TOYOTA (COROLLA)	▪
A KV 198	F 16069		OPEL (ASTRA)	▪
A KV 199	F 16070		OPEL (ASTRA * ZAFIRA)	▪
KA 200	33108 F	32206 F	CITROËN (C25), FIAT (DUCATO), PEUGEOT (J5)	▪
KF 201	F 16036		FORD (FIESTA * FOCUS * FUSION), MAZDA (2)	▪
A KV 202	F 16073		OPEL (ASTRA * VECTRA)	▪
KF 203	F 16024		SEAT (IBIZA * MALAGA * RONDA)	▪
KV 204	F 16072		FIAT (PANDA), SEAT (MARBELLA)	▪
KC 205	6306 2RS		FSO (125 * POLONEZ), LADA (NIVA)	▪
KA 206	30304 F	30206 F	ARO TV * MOSKVICH	
KA 207	30208 F	30208 F	ARO TV * MOSKVICH	
KA 208	30209 F	30209 F	ARO TV * MOSKVICH	
KC 209	6306 2RS	6306 2RS	ARO TV * MOSKVICH	
KA 210	L 44645/ L 44613	L 44645/ L 44613	FIAT (126 * 500 * 600), FSO (126), SEAT (600)	▪
KA 211	U 399/U 360 L+ COLLAR		VOLVO (140 * 164 * 240 * 260 * 740 * 760 * P-1800)	▪
KA 212	U 399/U 360 L+ COLLAR		VOLVO (740 * 760 * 780 * 940 * 960)	▪
KA 213	05-02-4911	01-03-4016	FIAT (126 * 500 * 600), FSO (126), SEAT (600)	▪



KF

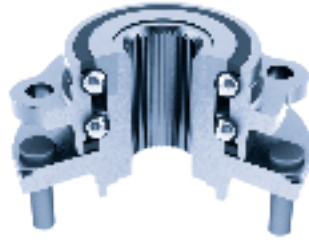

KV

- KA Single row tapered roller bearings / Rodamientos de rodillos cónicos
- KB Double row tapered roller bearings / Rodamientos cónicos de doble hilera
- KC Ball bearings / Rodamientos de bolas
- KD Double row ball bearings / Rodamientos de bolas de doble hilera
- KF Double row angular contact ball bearings / Rodamientos de bolas de doble hilera de contacto angular
- KV 2nd and 3rd generation wheel hub units / Rodamientos de rueda con brida de 2ª y 3ª generación

Fersa			
KA 214	JL 69349/ JL 69310	JL 69349/ JL 69310	MAZDA (121 * 323) ■
KV 215	F 16136		CITROËN (BX), PEUGEOT (405) ■
KF 216	REPLACED BY KF 182 / SUSTITUIDO POR EL KF 182		
KB 217	F 15137		NISSAN (SUNNY) ■
P KV 218	F 16137		ALFA ROMEO (145 * 146 * 155) ■
P KV 219	F 16138		CITROËN (XSARA * ZX), PEUGEOT (205 * 306) ■
KV 220	F 16139		FORD (FIESTA * COUGAR * MONDEO) ■
P KV 221	F 16140		FORD (FIESTA * COUGAR * MONDEO) ■
P KV 222	F 16141		FORD (MONDEO) ■
KC 223	6007 2RS/C3	6007 2RS/C3	SUZUKI (ALTO * SWIFT) ■
KC 224	6204 2RS/C3	6205 2RS/C3	SUZUKI (ALTO * SWIFT), DAEWOO (TICO) ■
KF 225	F 16088		KIA (CARENS * SHUMA * SEPHIA), MAZDA (323 * 626 * 6 * MVP * MX-5 * MX-6 * XEDOS 6 * XEDOS 9) ■
KV 226	F 16142		MAZDA (323 * 626) ■
KF 227	F 16089		KIA (SHUMA * SEPHIA), MAZDA (323 * MX-5 * MX-6) ■
KV 228	F 16143		MITSUBISHI (GALANT) ■
KV 229	F 16144		HONDA (ACCORD), ROVER (600) ■
KV 230	F 16145		HYUNDAI (ACCENT) ■
KV 231	F 16146		HYUNDAI (ACCENT) ■
KV 232	F 16147		MAZDA (323 * MX-3) ■
KF 233	F 16085		WV (TRANSPORTER) ■
KV 234	F 16148		VOLVO (S70 * V70 * C70 * 850) ■
KV 235	F 16149		OPEL (ASTRA * MERIVA * VECTRA) ■
P KV 236	F 16150		CITROËN (EVASION * JUMPY), FIAT (SCUDO * ULYSSE), LANCIA (ZETA), PEUGEOT (806 * EXPERT) ■
P KV 237	F 16151		ALFA ROMEO (145 * 146), FIAT (BRAVA * BRAVO * BARCETTA * MAREA) ■
P KV 238	F 16152		BMW (SERIE 5 * СЕРИЯ 5 * Z8) ■
P KV 239	F 16153		BMW (SERIE 5 * СЕРИЯ 5) ■
KF 240	F 16086		FORD (GALAXY), SEAT (ALHAMBRA), WV (SHARAN) ■
KF 241	F 16086		FORD (GALAXY), SEAT (ALHAMBRA), WV (SHARAN) ■
KV 242	F 16154		VOLVO (S40 * V40) ■
P KV 243	F 16155		RENAULT (LAGUNA) ■
KV 244	F 16156		RENAULT (LAGUNA) ■
KV 245	F 16188		VOLVO (S70 * V70 * C70 * 850) ■

12\ Passenger car wheel bearing kits

Kits de rueda para turismos



KA



KB



KC



KD

Fersa				
P KV 246	F 16157		RENAULT (MEGANE * SCENIC)	▪
KV 247	F 16158		OPEL (ASTRA * ZAFIRA)	▪
KA 248	LM 11949/10	L 45449/10	AUDI (A4 * CABRIO), SEAT (INCA), WV (CADDY)	▪
KV 249	F 16159		VOLVO (S70 * V70 * C70)	▪
KV 250	F 16160		AUDI (A4 * A6 * A8), SEAT (EXEO), WV (PASSAT)	▪
A KV 251	F 16161		ALFA ROMEO (146 * 145 * MITO), CITROËN (NEMO), FORD (KA), LANCIA (DELTA * LYBRA * MUSSA * Y * YPSILON), FIAT (BARCHETTA * BRAVA * BRAVO * FIORINO * MAREA * MULTIPLA * PALIO * PANDA * PUNTO * ESTILO * 500)	▪
P KV 252	F 16162		OPEL (ASTRA * COMBO * ZAFIRA * MERIVA * VECTRA), SAAB (9-3 * 9-5 * 900)	▪
KC 253			FIAT (ARGENTA * 124 * 125 * 131 * 132), FSO (125P)	▪
KA 254	LM 67049/14	LM 67049/14	AUSTIN (MINI), ROVER (MINI)	▪
KA 255	JLM 104945/10	JLM 104945/10	RENAULT (MASTER)	▪
KC 256	6207 C3	F 19074	WV (TRANSPORTER)	▪
KA 257	F 15164	F 15164	FORD (SCORPIO * MONDEO * SIERRA)	▪
KV 258	F 16163		RENAULT (SPACE * FUEGO * MEGANE * SCENIC * EXPRESS * SAFRANE * 18 * 21 * 25 * 30)	▪
KF 259	F 16034		TOYOTA (CAMRY * CARINA * CELICA * MR2 * RAV4)	▪
KV 260	F 16164		HONDA (ACCORD * CIVIC)	▪
KF 261	F 16031		ALFA ROMEO (164), FIAT (CROMA * TEMPRA), LANCIA (DEDRA * DELTA * PRISMA * THEMA)	▪
KB 262	REPLACED BY KB 192 / SUSTITUIDO POR EL KB 192			
KB 263	F 15068		FORD (TRANSIT)	▪
KF 264	F 16107		ALFA ROMEO (145 * 146 * 155 * 164 * GTV * SPIDER), FIAT (BRAVO * COUPE * CROMA * MAREA), LANCIA (DELTA * KAPPA * THEMA)	▪
KC 265			SUZUKI (JIMNY * SAMURAI * SJ)	▪
KA 266	30208 F		NISSAN (PICK UP * TERRANO * URBAN)	▪
KV 267	F 16165		NISSAN (MICRA)	▪
KA 268	32209 F		NISSAN (PATROL)	▪
KA 269	32205 BF	32007 XF	RENAULT (TRAFFIC)	▪
KF 270	F 16093		FIAT (PUNTO)	▪
KV 271	F 16166		VOLVO (S70 * V70 * C70 * 850)	▪
KA 272	32011 XF	32011 XF	CITROËN (JUMPER), FIAT (DUCATO), PEUGEOT (BOXER)	▪
KA 273	33205 F	LM 501349/10	MERCEDES (T1, * SPRINTER), WV (LT)	▪
KF 274	F 16132		BMW (3 * 5)	▪



KF

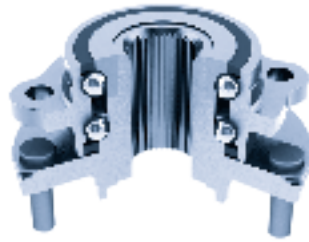

KV

- KA Single row tapered roller bearings / Rodamientos de rodillos cónicos
- KB Double row tapered roller bearings / Rodamientos cónicos de doble hilera
- KC Ball bearings / Rodamientos de bolas
- KD Double row ball bearings / Rodamientos de bolas de doble hilera
- KF Double row angular contact ball bearings / Rodamientos de bolas de doble hilera de contacto angular
- KV 2nd and 3rd generation wheel hub units / Rodamientos de rueda con brida de 2ª y 3ª generación

Fersa			
KV 275	F 16167		CITROËN (SAXO), PEUGEOT (106) ■
P KV276	F 16168		AUDI (A6), SKODA (SUPERB), WV (PASSAT * SANTANA) ■
P KV277	F 16108		RENAULT (LAGUNA) ■
KB 278	F 15168		OPEL (MOVANO), RENAULT (MASTER) ■
KV 279	F 16169		OPEL (ASTRA, ZAFIRA) ■
KF 280	F 16109		MERCEDES (CLASE M) ■ ■
KF 281	F 16002		FIAT (PALIO * SIENA * STRADA) ■
A KF 282	F 16110		FORD (FIESTA * FUSION * FOCUS) ■
P KV 283	F 16111		ALFA ROMEO (146 * 145 * MITO), CITROËN (NEMO), FORD (KA), LANCIA (DELTHA * LYBRA * MUSSA * Y * YPSILON) FIAT (BARCHETTA * BRAVA * BRAVO * FIORINO * MAREA * MULTIPLA * PALIO * PANDA * PUNTO * ESTILO * 500) ■
P KV 284	F 16170		SEAT (AROSA * CORDOBA * IBIZA), WV (LUPO * POLO) ■
P KV 285	F 16171		AUDI (A2), WV (LUPO) ■
A KV 286	F 16172		AUDI (A2), SEAT (CORDOBA * IBIZA), SKODA (FABIA), WV (FOX * POLO) ■
P KV 287	F 16173		AUDI (A2), SEAT (CORDOBA * IBIZA), SKODA (FABIA), WV (FOX * POLO) ■
P KV 288	F 16112		FIAT (PANDA * SEICENTO * 500), FORD (KA) ■
P KV 289	F 16113		CITROËN (BERLINGO * C3 * C4 * C5), PEUGEOT (207 * 307 * 308 * 3008 * PARTNER) ■
P KV 290	F 16174		CITROËN (C4), PEUGEOT (307) ■
KV 291	F 15154		FORD (TRANSIT) ■
KF 292	F 16083		OPEL (COMBO * CORSA * MERIVA * TIGRA) ■
KB 293	F 15168		OPEL (MOVANO), RENAULT (MASTER) ■
P KV294	F 16175		CITROËN (C8), FIAT (ULYSSE), LANCIA (PHEDRA), PEUGEOT (807) ■
KB 295	F 15168		CITROËN (JUMPER), FIAT (DUCATO), PEUGEOT (BOXER) ■
KB 296	F 15121		CITROËN (JUMPER), FIAT (DUCATO), PEUGEOT (BOXER) ■
P KV 297	F 16176		BMW (SERIE 3 * СЕРИЯ 3 * Z3 * Z4) ■
KF 298	F 16068		TOYOTA (COROLLA) ■
KF 299	F 16057		HYUNDAI (ACCENT * ATOS * COUPE * GETZ * LANTRA), KIA (RIO) ■
KF 300	F 16114		FORD (TRANSIT) ■
KF 301	F 16115		SUZUKI (SWIFT) ■
KF 302	F 16116		VOLVO (S40) ■
KF 303	F 16046		BMW (Z1 * Z3) ■

12\ Passenger car wheel bearing kits

Kits de rueda para turismos



KA



KB



KC



KD

Fersa				
KF 304	F 16117		HONDA (CIVIC IV-V, CR-V, LOGO)	▪
KV 305	F 16177		CITROËN (XSARA), PEUGEOT (306)	▪
KF 306	F 16054		AUDI (A4,A8,ALLROAD, V8, A8, COUPE, CABRIO, 80, 100, 200) SKODA (SUPERB), WV (PASSAT)	▪
KF 307	F 16054		AUDI (A4,A8,ALLROAD, V8, A8, COUPE, CABRIO, 80, 100, 200) SKODA (SUPERB), WV (PASSAT)	▪
KF 308	F 16118		AUDI (A4,A8)	▪
KF 309	F 16119		RENAULT (LAGUNA * MEGANE * SAFRANE)	▪
KF 310	F 16120		TOYOTA (PASEO)	▪
KF 311	F 16105		LEXUS (RX), TOYOTA (AVENSIS)	▪
KF 312	F 16121		RENAULT (AVANTTIME, ESPACE III)	▪
KF 313	F 16122		CITROËN (XM), PEUGEOT (605, 607)	▪
KF 314	F 16051		RENAULT (TRAFFIC)	▪
KF 315	F 16123		NISSAN (PRIMASTAR), OPEL (VIVARO)	▪
KF 316	F 16119		TOYOTA (CAMRY, MR2, PICNIC)	▪
KF 317	F 16090		HYUNDAI (SONATA), MITSUBISHI (SPACE WAGON, TREDIA)	▪
KB 318	F 15172		NISSAN (SERENA * VANETTE * 300Z)	▪
KF 319	F 16191		OPEL (AGILA)	▪
KF 320	F 16124		HONDA (CIVIC I-II-III), ROVER (200)	▪
KF 321	F 16125		NISSAN (MICRA)	▪
P KV 322	F 16178		FORD (FOCUS, C-MAX)	▪
KV 323	F 15177		FORD (TRANSIT)	▪
P KV 324	F 15178		FORD (TRANSIT)	▪
KV 325	F 15179		FORD (TRANSIT)	▪
P KV 326	F 15180		FORD (TRANSIT)	▪
KF 327	F 16036		FORD (ESCORT, FIESTA, PUMA, ORION)	▪
P KV 328	F 16179		FORD (MONDEO), JAGUAR (X-TYPE),	▪
P KV 329	F 16126		FORD (MONDEO), JAGUAR (X-TYPE),	▪
P KV 330	F 16180		OPEL (ASTRA)	▪
P KV 331	F 16181		OPEL (ASTRA, ZAFIRA)	▪
P KV 332	F 16182		OPEL (ASTRA, ZAFIRA)	▪
P KV 333	F 16183		OPEL (ASTRA)	▪
KF 334	F 16127		NISSAN (PRIMASTAR), OPEL (VIVARO), RENAULT (SPACE, VEL SATIS, TRAFFIC)	▪
P KV 335	F 16184		OPEL (SIGNUM, VECTRA)	▪
P KV 336	F 16185		FIAT (CROMA), OPEL (SIGNUM, VECTRA), SAAB (9-3)	▪



KF

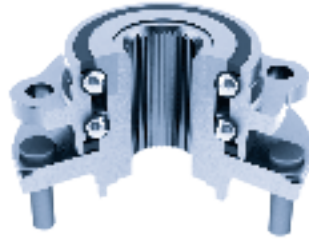

KV

- KA Single row tapered roller bearings / Rodamientos de rodillos cónicos
- KB Double row tapered roller bearings / Rodamientos cónicos de doble hilera
- KC Ball bearings / Rodamientos de bolas
- KD Double row ball bearings / Rodamientos de bolas de doble hilera
- KF Double row angular contact ball bearings / Rodamientos de bolas de doble hilera de contacto angular
- KV 2nd and 3rd generation wheel hub units / Rodamientos de rueda con brida de 2ª y 3ª generación

Fersa			
KV 337	F 16186		OPEL (CORSA, TIGRA) ■
KB 338	F 15128		OPEL (CORSA, TIGRA) ■
KB 339	F 15173		NISSAN (PRIMASTAR), OPEL (VIVARO), RENAULT (SPACE, TRAFFIC) ■
P KV 340	F 16128		NISSAN (PRIMASTAR), OPEL (VIVARO), RENAULT (SPACE) ■
KF 341	F 16129		OPEL (AGILA) ■
KF 342	F 16130		OPEL (AGILA) ■
P KV 343	F 16187		FIAT (CROMA), OPEL (SIGNUM, VECTRA), SAAB (9-3) ■
KB 344	F 15174		RENAULT (MASTER), OPEL (MOVANO) ■
KB 345	F 15043		MERCEDES (CLASE A), ■
P KV 346	F 16131		CITROËN (NEMO), FIAT (BRAVO, FIORINO, IDEA) ■
KA 347	F 15164	F 15164	FORD (SCORPIO, ESCORT, SIERRA) ■
KF 348	F 16132		BMW (3 * 7 * 850 * X3 * Z3 * Z4) ■
KA 349	30304 F	30206 F	SKODA (105, 130, RAPID) ■
KB 350	F 15175		RENAULT (CLIO, MEGANE, MODUS) ■
P KV 351	F 16133		DACIA (LOGAN, SANDERO), NISSAN (MICRA), RENAULT (CLIO) ■
KF 352	F 16134		TOYOTA (COROLLA) ■
KV 353	F 16192		TOYOTA (YARIS) ■
P KV 354	F 16135		CITROËN (C2, C3, DS3), PEUGEOT (207, 1007) ■
KB 356	F 15187		IVECO (DAILY I) ■
KB 357			CITROËN (C4), PEUGEOT (307) ■
P KV 358			AUDI (A3), SEAT (ALTEA, LEON), SKODA (OCTAVIA) ■
P KV 359			AUDI (A3), SKODA (OCTAVIA) ■
P KV 360			AUDI (A3), SEAT (ALTEA * LEON), SKODA (OCTAVIA * YETI), VW (CADDY III * GOLF V * TOURAN) ■
P KV 361			AUDI (A3 * TT), SEAT (ALHAMBRA * ALTEA * TOLEDO), SKODA (OCTAVIA * SUPERB), VW (EOS * GOLF * JETTA * PASSAT * SCIROCCO * SHARAN * TIGUAN * TOURAN) ■
KB 362	F 15121		IVECO (DAILY I * II) ■
P KV 363			JEEP (GRAND CHEROKEE II) ■
KB 364			RENAULT (MEGANE II, SCENIC, GRAND SCENIC) ■
KB 365			KIA (CARNIVAL) ■
P KV 366			RENAULT (CLIO III * MEGANE * MODUS * SCENIC * GRAND SCENIC * TWINGO) ■
P KV 367			AUDI (A3 * TT), SEAT (ALTEA * ALHAMBRA * TOLEDO), SKODA (OCTAVIA * SUPER-B * YETI), VW (EOS * GOLF * JETTA * PASSAT/SCIROCCO * TIGUAN * TOURAN) ■

12\ Passenger car wheel bearing kits

Kits de rueda para turismos



KA



KB



KC



KD

Fersa				
KB 368	F 15041		CITROËN (C2 * C3 *), PEUGEOT (1007)	▪
KB 369			CITROËN (C3 * C4 * DS3), PEUGEOT (207 * 307)	▪
KF 370	F 16079		TOYOTA (AVENSIS * COROLLA)	▪
KF 371			RENAULT (CLIO * KANGOO * SCENIC * MEGANE)	▪
KB 372	F 15121		CITROËN (JUMPER), FIAT (DUCATO), PEUGEOT (BOXER)	▪
P KV 373			FIAT (BRAVO * STYLO), LANCIA (DELTA III)	▪
KV 374			MINI	▪
P KV 375			RENAULT (LAGUNA)	▪
KF 376	F 16019		CHEVROLET-DAEWOO (LANOS * KALOS)	▪
P KV 377			ALFA ROMEO (147 * 156 * GT)	▪
P KV 378			BMW (SERIE 3 * 5 * СЕРИЯ 3 * 5 * X3 * X5)	▪
KF 380			NISSAN (ALMERA TINO * MAXIMA * PRIMERA * X-TRAIL)	▪
KF 381			NISSAN (ALMERA * MICRA)	▪
KF 382	F 16079		TOYOTA (ALVIS * AVENSIS * CELICA * COROLLA * MR2 * WISH LIMUSNIA)	▪
KA 383	F 15029	F 15029	FORD (ESCORT, FIESTA * KA * PUMA * STREET KA)	▪
KB 384	F 15067		FORD (FIESTA V * FOCUS * FUSION)	▪
			FORD (TOURNEO CONNECT)	▪
KV 386			FORD (FOCUS C-MAX * C-MAX * FOCUS II)	▪
KV 387			FORD (TRANSIT TOURNEO * TRANSIT AUTOBUS)	▪
KF 388			HYUNDAI (COUPE * ELANTRA * MATRIX), KIA (CERATO)	▪
KA 389	L 44649/10	LM 11949/10	KIA (RIO), MAZDA (626 II Hatchback)	▪
KB 390			FIAT (DUCATO)	▪
KF 391			CITROËN (JUMPER), FIAT (DUCATO), PEUGEOT (BOXER)	▪
KA 392	LM 300849/11	LM 603049/11	NISSAN (PATHFINDER * TERRANO I-II * PICK UP)	▪
KA 393	JL 69349/10	JL 69349/10	KIA (PRIDE * RIO), MAZDA (121 * DEMIO)	▪
P KV 394			WV (MULTIVAN, TUAREG * TRANSPORTER *)	▪
P KV 395			AUDI (A4) SEAT (EXEO)	▪
KF 396			BMW (5 * 6 * 7)	▪
KA 397	JL 69349/10	LM 102949/10	KIA (SPORTAGE)	▪
P KV 398			ALFA ROMEO (147)	▪
P KV 399			CITROËN (C5 * C6), PEUGEOT (308 * 407 * 508 * 607)	▪
KB 400			NISSAN (VANETTE * SERENA * TERRANO)	▪
KV 401			VOLVO (XC-90)	▪
KB 402	F 15174		OPEL (MOVANO), RENAULT (MASTER)	▪



KF

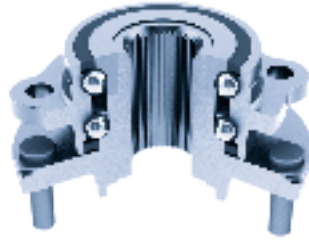

KV

- KA Single row tapered roller bearings / Rodamientos de rodillos cónicos
- KB Double row tapered roller bearings / Rodamientos cónicos de doble hilera
- KC Ball bearings / Rodamientos de bolas
- KD Double row ball bearings / Rodamientos de bolas de doble hilera
- KF Double row angular contact ball bearings / Rodamientos de bolas de doble hilera de contacto angular
- KV 2nd and 3rd generation wheel hub units / Rodamientos de rueda con brida de 2ª y 3ª generación

Fersa				
KV 403			CITROËN (XANTIA), PEUGEOT (406)	▪
KA 404			ISUZU (TROOPER * D-MAX), OPEL (CAMPO * FRONTERA * MONTERREY)	▪
KA 405	L 68149/11	L 68149/11	CHEVROLET-DAEWOO (MATIZ * SPARK)	▪
KA 406			MERCEDES (CLS * CLASE E * SL)	▪
KA 407			KIA (CARNIVAL)	▪
P KV 408			MITSUBISHI (COLT), SMART (FORFOUR)	▪
P KV 409			FIAT (DOBLO * FIORINO * STYLO)	▪
P KV 410			CITROËN (C5 * C6), PEUGEOT (407 * 607)	▪
P KV 411			ALFA ROMEO (147 * 156 * GT), LANCIA (THESIS)	▪
KV 412			HYUNDAI (ACCENT * LANTRA * COUPE)	▪
KA 413	30205 F	30204 F	CHEVROLET-DAEWOO (MATIZ * SPARK)	▪
KA 414			MERCEDES (CLASE C * CLC * CLK * SLK * CLASE E)	▪
KA 415	LM 11749/10	L 44649/10	HYUNDAI (ATOS * PONY), MITSUBISHI (CELESTE * COLT * CORDIA * GALANT * LANCER * APSCEWAGON * TREDIA)	▪
KB 416			SUBARU (IMPREZA * FORESTER * LEGACY I-II)	▪
KF 417			SUZUKI (JIMNY)	▪
KF 418			BMW (1 * 3 * Z4)	▪
KC 419			SUZUKI (VITARA * X-90)	▪
P KV 420			SEAT (INCA), VW (CADDY)	▪
P KV 421			AUDI (Q7), PORSCHE (CAYENNE) VW (TOUAREG)	▪
KB 422			MERCEDES (G * SPRINTER) VW (LT)	▪
KA 423			MITSUBISHI (STORM * STRADA * L200 * L300 * L400)	▪
KB 424			CITROËN (JUMPER), FIAT (DUCATO), PEUGEOT (BOXER)	▪
P KV 425			AUDI (A6 * A8), VW (TOUAREG)	▪
KF 426			HONDA (ACCORD * CIVIC * CR-V * PRELUDE * STREAM * S2000)	▪
KV 427			TOYOTA (LAND CRUISER)	▪
KF 428			CHEVROLET (NUBIRA * LACETTI * OPTRA * TACUMA * VIVANT)	▪
KF 429			TOYOTA (ECHO * BIOS * YARIS * VITZ * YARIS VERSO)	▪
KA 430			NISSAN (PATROL)	▪
KV 431			BMW (5 * 6)	▪
KV 432			BMW (1 * 3 * Z4)	▪
KF 433			SAAB (9-3 * 9-5)	▪

12\ Passenger car wheel bearing kits

Kits de rueda para turismos



KA



KB



KC



KD

Fersa				
P KV 434			CITROËN (C8), FIAT (ULYSSE), LANCIA (PHEDRA), PEUGEOT (807)	▪
P KV 435			CITROËN (C2 * C3), PEUGEOT (206 * 1007)	▪
KB 436			MERCEDES (CLASE E RANCHERA FAMILIAR)	▪
P KV 437			OPEL (CORSA)	▪
KV 438			HIUNDAI (ELANTRA * MATRIX)	▪
KV 439			CHRYSLER (VOYAGER), DODGE (CARAVAN)	▪
P KV 440			RENAULT (AVANTIME * SPACE II-III)	▪
KF 441			LANDROVER (FREELANDER)	▪
KF 442			NISSAN (X-TRAIL)	▪
KB 443				▪
KC 444			SUZUKI (CARRY * SJ)	▪
P KV 445			CITROËN (C5)	▪
KF 446	F 16040		AUDI (A3 * TT), SEAT (LEON), VW (GOLF)	▪
P KV 447			ALFA ROMEO (147 * 156 * GT)	▪
KF 448	F 16036		DAEWOO (LANOS * NUBIRA)	▪
P KV 449			MG, ROVER (45 * 25 * 400 * 200)	▪
KF 450			MERCEDES (CLASE A * Vaneo)	▪
KV 451			TOYOTA (AVENSIS 2.0 TD 97-03)	▪
P KV 452			MG ROVER (75)	▪
KF 453	F 16063		FORD (TRANSIT)	▪
P KV 454			VOLVO (C30 * S40 * V50 * C70)	▪
KA 455	LM 300849/11	LM 12749/10	WV (TRANSPORTER)	▪
KF 456	F 16034		TOYOTA (CARINA * CELICA * COROLLA)	▪
KV 457			MG, ROVER (45 * 25 * 400 * 200)	▪
P KV 458			CITROËN (BERLINGO * XSARA), PEUGEOT (PARTNER)	▪
P KV 459			CITROËN (XSARA), PEUGEOT (306)	▪
P KV 460			CITROËN (BERLINGO * XSARA), PEUGEOT (PARTNER)	▪
P KV 461			OPEL (CORSA)	▪
P KV 462			MINI	▪
KC 463			SUZUKI (VITARA)	▪
KB 464			CITROËN (BERLINGO * C4), PEUGEOT (308 * 3008 * 5008 * PARTNER)	▪
KF 465	F 16027		FIAT (TIPO)	▪
KF 466	F 16034		TOYOTA (CARINA * CELICA * RAV4)	▪
KV 467			VOLVO (S60 * V70 * XC70 * S80)	▪



KF

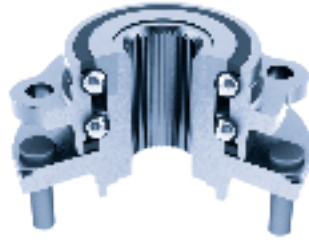

KV

- KA Single row tapered roller bearings / Rodamientos de rodillos cónicos
- KB Double row tapered roller bearings / Rodamientos cónicos de doble hilera
- KC Ball bearings / Rodamientos de bolas
- KD Double row ball bearings / Rodamientos de bolas de doble hilera
- KF Double row angular contact ball bearings / Rodamientos de bolas de doble hilera de contacto angular
- KV 2nd and 3rd generation wheel hub units / Rodamientos de rueda con brida de 2ª y 3ª generación

Fersa			
KF 468	F 16093		FIAT (PANDA * SEICENTO * TIPO * CINQUECENTO) ■
KB 469			MERCEDES (CLASE E) ■
KF 470	F 16036		BMW (3 * Z3) ■
P KV 471			ALFA ROMEO (156), FIAT (BRAVO * STYLO), LANCIA (DELTA) ■
P KV 472			BMW (5 * 6 * 7 * X5) ■
P KV 473			CITROËN (JUMPY), FIAT (SCUDO), PEUGEOT (EXPERT) ■
P KV 474			FIAT (PUNTO) ■
KF 475			HIUNDAI (i10), KIA (PICANTO) ■
KA 476	32207 F	32205 BF	RENAULT (TRAFFIC * MASTER) ■
KC 477			LADA (NIVA) ■
KV 478			VOLVO (S60 * V70 * S80) ■
KF 479	F 16038		AUDI (A6) ■
P KV 480			VOLVO (S60 * V70 * XC70 * S80) ■
KV 481			DAEWOO (LEGANZA) ■
KV 482			TOYOTA (VIOS * YARIS * VITZ * YARIS VERSO) ■
KA 483	JL 69349/310	LM 102949/10	MAZDA (B-SERIE * B-СЕРИЯ * E-SERIE * E-СЕРИЯ) ■
P KV 484			FORD (TOURNEO * TRAFFIC) ■
KV 485			HYUNDAI (COUPE) ■
KV 486			AUDI (A3 * TT), SEAT (ALTEA * ALHAMBRA * LEON), SKODA (OCTAVIA * SUPERB * YETI), VW (CADDY * GOLF * PASSAT * SHARAN * TUGUAN) ■
KF 487			HYUNDAI (SANTA FÉ * ix35 * SONATA V * TRAJET * TUCSON * XG), KIA (SPORTAGE) ■
KC 488			TOYOTA (HILUX * LAND CRUISER * HICAE * 4 RUNNER), VW (TARO) ■
KV 489			KIA (SEPHIA * SHUMA) ■
KV 490			MITSUBISHI (GALANT) ■
KB 491			MITSUBISHI (MONTERO) ■
P KV 492			RENAULT (LAGUNA) ■
P KV 493			JAGUAR (S-TYPE) ■
KF 494			JAGUAR (XJ * S-TYPE) ■
KF 495			SUZUKI (BALENO) ■
KB 496	F 15015		SUZUKI (GRAND VITARA * VITARA * X-90) ■
KV 497			MAZDA (323 * 626 * 6 * MPV * PREMACY * XEDOS 90) ■
KF 498			TOYOTA (COROLLA * PRIUS) ■
KA 499	1988/1922	LM 11949/10	FORD (CAPRI * CORSAIR * CORTINA * ESCORT * ZEPHIR * ZODIAC * ZODIAC) ■

12\ Passenger car wheel bearing kits

Kits de rueda para turismos



KA



KB



KC



KD

Fersa				
KF 500			CITROËN (2CV * DYANE * MEHARI)	▪
KV 501			HONDA (CITY * JAZZ)	▪
KA 502	LM 67048/10	LM 11949/10	PORSCHE (911 * 924 * 944)	▪
KV 503			NISSAN (PRIMERA)	▪
KF 504			SAAB (9-3 * 9-5 * 900)	▪
P KV 505			MG ROVER (45 * 25 * 400 * 200 * COUPE * GT)	▪
KV 506			SAAB (9-5)	▪
P KV 507			CITROËN (C1), PEUGEOT (107), TOYOTA (AYGO)	▪
KF 508			HYUNDAI (ELANTRA * SONATA), KIA (MAGENTIS)	▪
KF 509			SUZUKI (ALTO * IGNIS * SWIFT * WAGON)	▪
P KV 510			ALFA ROMEO (MITO), FIAT (PUNTO * 500)	▪
P KV 511			AUDI (A6)	▪
P KV 512			BMW (1 * 3 * 3 TOURING)	▪
KV 513			HYUNDAI (ACCENT)	▪
KV 514			VOLVO (850)	▪
KA 515	LM 503349 A/10	32206 F	MERCEDES (100)	▪
KF 516			VOLVO (540 * V40)	▪
KA 517	LM 501349/10	LM 503349 A/10	JAGUAR (XJ)	▪
P KV 518			SKODA (FABIA; VW (POLO)	▪
KF 519	F 16054		AUDI (A4 * AVANT * CABRIO)	▪
P KV 520			NISSAN (KUBISTAR), RENAULT (KANGOO)	▪
KV 521			KIA (CLARENS * CLARUS)	▪
KC 522			SUZUKI (JIMNY)	▪
P KV 523			FIAT (STYLO)	▪
KV 524			OPEL (CORSA)	▪
P KV 525			HONDA (CITY * JAZZ * CR-V)	▪
KV 526			HYUNDAI (MATRIX * ELANTRA)	▪
KV 527			SUZUKI (GRAND VITARA)	▪
KV 528			TOYOTA (RAV 4 III * AURISAVENSIS * COROLLA)	▪
KF 529			MITSUBISHI (CARISMA * SPACE STAR)	▪
KV 530			NISSAN (SUNNY * ALMERA)	▪
KV 531			CHEVROLET DAEWOO (TACUMA * VIVANT)	▪
KV 532			BMW (7)	▪
KA 533			JAGUAR (XJ)	▪
P KV 534			ALFA ROMEO (166)	▪

Fersa Accessories







Accesorios Fersa

13.1\	Fersa tools / Herramientas Fersa	178
13.2\	Grease / Grasa	180
13.3\	Maintenance bearings Kit / Kit de mantenimiento de rodamientos	182

13



13.1 \ Fersa tools Herramientas Fersa

Fersa	PICTURE	BRAND	REMARKS
PRESS TOOL KITS / KIT DE HERRAMIENTAS PARA PRENSA			
BTA 001		VOLVO	F 200013 \ F 200014 \ F 200015
BTA 003		BPW	32310 F \ 33116 F
BTA 005		DAF	F 200016 \ F 200017 \ F 200018 \ F 200019
BTA 006		Universal	For complete disassembly and assembly with press \ Para el desmontaje y montaje de rodamientos con prensa
BTA 007		SCANIA	F 15097 \ HM 218248/10
N BTC 038		SCANIA	Disassembly and Assembly F 15097 / Desmontaje y Montaje F15097

Fersa	PICTURE	BRAND	REMARKS
N BTC 032		Mercedes Benz	Disassembly F 15100 / Desmontaje F 15100
N BTC 041		Mercedes Benz	Assembly F 15100 / Montaje F 15100
N BTC 047		SAF	ABS Assembler SAF 148mm
N BTC 081		SAF	ABS Assembler SAF 156mm

HYDRAULIC BUSHINGS EXTRACTOR \ EXTRACTOR HIDRÁULICO DE BUJES

N BTA 009		Universal	<p>The Hydraulic Bushings Extractor is a set that includes the plate extractor and Fersa links. These, together with the cylinder and the manual hydraulic pump, facilitate the quick and safe removal up to a maximum of 23 tons. \</p> <p>El Extractor Hidráulico de Bujes es un conjunto que incluye la placa extractora y los acoplamientos de Fersa. Estos, unidos al cilindro y la bomba hidráulica manual, facilitan una extracción rápida y segura, hasta un máximo de 23 toneladas.</p>
-----------	---	-----------	--

INNER RING EXTRACTOR / EXTRACTOR DE CONOS

By Part Number/ Por referencia		Universal	Make to order, designs adapted to each part number / Fabricación bajo encargo, diseños adaptados a cada referencia.
-----------------------------------	---	-----------	---

13.3 Maintenance bearings Kit Kit de mantenimiento de rodamientos



Fersa
KRBC F 200013
KRBC F 200014
KRBC F 200015
KRBC F 200032



A series of horizontal dotted lines for writing notes, corresponding to the pencil icon above.



A series of horizontal dotted lines for writing notes, corresponding to the pencil icon above.



A series of horizontal dotted lines for writing, filling the left column of the page.

A series of horizontal dotted lines for writing, filling the right column of the page.

Lists & Cross part number

Listados y cruces de referencias

14.1\	Fersa special part number numerical list / Lista numérica de referencias especiales de Fersa	186
14.2\	Fersa dimensional list / Lista dimensional Fersa	192
14.3\	Cross part number / Cruces de referencias	212

Nomenclatures / Nomenclaturas		
AIR	Air conditioning	Aire acondicionado
BB	Standard ball bearing	Rodamientos de bolas estándar
BB4PAC	Four point angular contact ball bearing	Rodamiento de bolas de cuatro puntos de contacto angular
BBC	Clutch release bearing	Rodamiento de embrague
BBDRAC	Standard double row angular contact ball bearing	Rodamientos de bolas de doble hilera de contacto angular estándar
BBDRACS	Special double row angular contact ball bearing /	Rodamiento de doble hilera de bolas de contacto angular especial
BBS	Special ball bearing	Rodamiento de bolas especial
BBT	Thrust ball bearing	Rodamiento axial de bolas
CONE	Inner rings	Conjuntos interiores
CRB	Standard cylindrical bearing	Rodamiento cilíndrico estándar
CRBS	Special cylindrical bearing	Rodamiento cilíndrico especial
FBOX	F-Box Rebuild Kit	Kit de reparación F-box
IB	Insert Bearings	Rodamiento autoalineables
KIT	Passenger car wheel bearing kit	Kit de rueda de turismo
NRBS	Special needle roller bearing	Rodamientos de agujas especiales
PHA	Preset hub assembly	Rodamientos integrales
PM	Pinion Module	Módulo de Piñón
TRBDR	Double row tapered roller bearing	Rodamientos cónicos de doble hilera
TRBF	Flange side bearing	Rodamiento con valona
TRBI	Inch series	Series pulgadas
TRBM	Metric series	Series métricas
TRBS	Special tapered roller bearing	Rodamiento de rodillos cónicos especial
TRBSt	Steering bearing	Rodamiento de dirección
TRBT	Thrust tapered roller bearing	Rodamiento axiales cónicos
U Series	U type bearing	Rodamiento de tipo U
WH	Wheel end Hub	Hub de rueda de camión
WK	Wheel end Kit	Kit de rueda de camión
WM	Wheel end module	Modulo de rueda de camión

14





14.1 \ Fersa special part number numerical list

Lista numérica de referencias especiales de Fersa

Fersa		PG.
F 15000 SERIE		
F 15001	TRBS	32
F 15002	TRBS	32
F 15003	TRBS	32
F 15004	BBT	104
F 15005	BBC	106
F 15014	TRBS	32
F 15015	TRBDR	52
F 15028	TRBS	32
F 15029	TRBS	32
F 15031	BBT	104
F 15034	BBT	104
F 15036	TRBS	32
F 15040	TRBS	32
F 15041	TRBDR	52
F 15042	TRBDR	52
F 15043	TRBDR	52
F 15044	TRBDR	52
F 15045	TRBDR	52
F 15046	TRBS	32
F 15047	TRBS	32
F 15048	TRBS	32
F 15050	TRBDR	52
F 15051 C	TRBS	32
F 15051 R	TRBS	32
F 15052	BBC	106
F 15054/3720	TRBS	32
F 15055/LM 29710	TRBS	32
F 15056	TRBS	32
F 15057	BBT	104
F 15058	BBT	104
F 15059	BBT	104
F 15060	BBT	104
F 15063	TRBS	32
F 15064	BBT	104
F 15067	TRBDR	52
F 15068	TRBDR	52
F 15071	TRBS	32
F 15075	TRBS	34
F 15076	TRBS	34
F 15080	TRBS	34
F 15082	TRBS	34
F 15083	TRBS	34
CONE F 15084	CONE	48
F 15088	TRBS	34
F 15089	TRBS	34
F 15090	TRBF	42
F 15091	BBT	104
F 15097	WH	136
F 15100	WH	136
CONE F 15101	CONE	48
F 15104	TRBS	34
F 15108	TRBF	42
F 15109	TRBS	34
CONE F 15110	CONE	48

Fersa		PG.
CONE F 15111	CONE	48
F 15112	TRBS	34
CONE F 15113	CONE	48
F 15114	TRBS	34
F 15115	TRBS	34
F 15116	TRBS	34
F 15117	TRBS	34
F 15118	BBC	106
F 15119	TRBS	34
F 15120	WH	136
F 15121	WH	136
F 15122	WH	136
F 15125	WH	136
F 15126	WH	136
F 15127	WH	136
F 15128	TRBDR	52
F 15129	TRBDR	52
F 15130	TRBDR	52
CONE F 15131	CONE	48
CONE F 15132	CONE	48
F 15133	TRBS	34
CONE F 15134	CONE	48
F 15139	BBC	106
F 15140	BBC	106
F 15141	BBC	106
F 15146	TRBDR	52
F 15149	TRBDR	52
CONE F 15150 A	CONE	48
F 15151	TRBDR	52
F 15154	TRBDR	52
F 15156	TRBS	34
F 15157	TRBS	34
F 15158	TRBS	34
F 15159	TRBS	34
F 15160	TRBDR	52
F 15161	TRBF	42
F 15165	TRBS	34
F 15168	TRBDR	54
F 15173	TRBDR	54
F 15174	TRBDR	54
F 15175	TRBDR	54
F 15183	TRBS	34
F 15184	TRBS	34
F 15187	TRBDR	54
F 15190	TRBS	34
F 15191	TRBF	42
F 15192	TRBF	42
F 15193	TRBS	36
F 15196	TRBF	42
F 15197	TRBS	36
F 15198	TRBF	42
F 15199	TRBS	36
F 15200	TRBS	36
F 15201	TRBS	36
F 15202	TRBS	36

Fersa		PG.
F 15203	TRBS	36
F 15208	TRBS	36
F 15209	BBC	106
F 15210	BBC	106
F 15211	BBC	106
F 15212	TRBF	42
CONE F 15213	CONE	48
F 15218	TRBDR	54
F 15224	BBC	106
F 15239	TRBS	36
CONE F 15244	CONE	48
F 15245	TRBS	36
F 15246	TRBF	42
CONE F 15249	CONE	48
F 15252	TRBS	36
F 15253	TRBS	36
F 15254	TRBS	36
F 15255	TRBS	36
F 15256	TRBS	36
F 15257	TRBS	36
F 15258	TRBS	36
F 15265	TRBF	42
F 15267	TRBS	36
F 15268	TRBDR	54
CONE F 15269	CONE	48
F 15270	TRBS	36
F 15271	TRBS	36
F 15272	TRBS	38
F 15273	TRBS	38
F 15278	TRBS	38
F 15279	TRBS	38
F 15280	TRBS	38
F 15291	TRBS	38
CONE F 15292	CONE	48
F 15295	TRBS	38
F 15298	TRBS	38
F 15300	WH	136
F 15302	TRBDR	54
F 15304	TRBS	38
F 15308	TRBS	38
F 15309	TRBS	38
F 15310	TRBF	42
F 15311	TRBF	42
F 15312	TRBF	42
F 15313	TRBS	38
F 15314	TRBS	38
F 15315	TRBS	38
F 15316	TRBS	38
F 15317	TRBS	54
F 15321	PM	38
F 15322	TRBS	38
F 15323	TRBS	38
F 15324	TRBDR	54
F 15326	TRBS	38
CONE F 15327	CONE	48

Fersa		PG.
CONE F 15328	CONE	48
F 15329	TRBS	38
F 15330	TRBDR	38
F 15332	TRBS	38
CONE F 15333	CONE	48
F 15334	TRBS	38
F 15336	TRBS	38
F 15337	TRBS	40
F 15338	TRBS	40
F 15339	TRBS	40
F 15340	TRBS	40
F 15341	TRBS	40
F 15342	TRBS	40
F 15345	TRBS	40
F 15346	TRBS	40
F 15347	TRBS	40
F 15348	TRBS	40
CONE F 15356	CONE	48
F 15357	TRBS	106
F 15360	TRBS	54
F 15361	TRBS	40
CONE F 15362	CONE	48
F 15365	FBOX	153
F 15366	TRBS	40
F 15367	TRBS	40
F 15371	PM	40
F 15376	TRBS	40
F 15377	TRBS	40
F 15380	TRBDR	40
F 15381	TRBDR	40
F 15382	TRBS	40
F 15383	TRBS	40
F 15384	TRBS	40
F 15385	TRBS	40
F 15386	TRBS	40
F 15387	FBOX	153
F 15388	TRBS	40

F 16000 SERIE		
F 16001	BBDRACS	82
F 16002	BBDRACS	82
F 16004	BBDRACS	82
F 16010	BBDRACS	82
F 16018	BBDRACS	82
F 16019	BBDRACS	82
F 16020	BBDRACS	82
F 16021	BBDRACS	82
F 16022	BBDRACS	82
F 16023	BBDRACS	82
F 16026	BBDRACS	82
F 16027	BBDRACS	82
F 16029	BBDRACS	82
F 16030	BBDRACS	84
F 16031	BBDRACS	84
F 16032	BBDRACS	84

14.1 \ Fersa special part number numerical list

Lista numérica de referencias especiales de Fersa

Fersa		PG.
F 16033	BBDRACS	84
F 16034	BBDRACS	84
F 16035	BBDRACS	84
F 16036	BBDRACS	84
F 16037	BBDRACS	84
F 16038	BBDRACS	84
F 16039	BBDRACS	84
F 16040	BBDRACS	86
F 16041	BBDRACS	86
F 16042	BBDRACS	86
F 16043	BBDRACS	86
F 16044	BBDRACS	86
F 16045	BBDRACS	86
F 16046	BBDRACS	86
F 16048	BBDRACS	86
F 16051	BBDRACS	86
F 16052	BBDRACS	86
F 16054	BBDRACS	86
F 16055	BBDRACS	86
F 16056	BBDRACS	88
F 16057	BBDRACS	88
F 16058	BBDRACS	88
F 16059	BBDRACS	88
F 16063	BBDRACS	88
F 16066	BBDRACS	88
F 16068	BBDRACS	88
F 16076	BBDRACS	88
F 16077	BBDRACS	88
F 16078	BBDRACS	88
F 16079	BBDRACS	88
F 16080	BBDRACS	88
F 16081	BBDRACS	88
F 16082	BBDRACS	88
F 16083	BBDRACS	88
F 16084	BBDRACS	90
F 16085	BBDRACS	90
F 16086	BBDRACS	90
F 16088	BBDRACS	90
F 16089	BBDRACS	90
F 16090	BBDRACS	90
F 16091	BBDRACS	90
F 16093	BBDRACS	90
F 16094	BBDRACS	90
F 16095	BBDRACS	90
F 16097	AIR	100
F 16098	AIR	100
F 16099	AIR	100
F 16100	AIR	100
F 16101	AIR	100
F 16102	AIR	100
F 16103	AIR	100
F 16104	AIR	100
F 16107	BBDRACS	90
F 16108	BBDRACS	90
F 16109	BBDRACS	90

Fersa		PG.
F 16110	BBDRACS	90
F 16115	BBDRACS	90
F 16117	BBDRACS	92
F 16118	BBDRACS	92
F 16120	BBDRACS	92
F 16121	BBDRACS	92
F 16123	BBDRACS	92
F 16124	BBDRACS	92
F 16128	BBDRACS	92
F 16129	BBDRACS	92
F 16189	AIR	100
F 16190	AIR	100
F 16193	BBDRACS	92
F 16194	BBDRACS	92
F 16195	BBDRACS	92
F 16196	BBDRACS	92
F 16197	BBDRACS	92
F 16198	BBDRACS	92
F 16199	BBDRACS	92
F 16200	BBDRACS	92
F 16201	BBDRACS	92
F 16202	BBDRACS	94
F 16203	BBDRACS	94
F 16204	BBDRACS	94
F 16205	BBDRACS	94
F 16207	BBDRACS	94
F 16208	BBDRACS	94
F 16209	BBDRACS	94
F 16210	BBDRACS	94
F 16211	BBDRACS	94
F 16213	BBDRACS	94
F 16214	BBDRACS	94
F 16215	BBDRACS	94
F 16216	BBDRACS	94
F 16217	BBDRACS	94
F 16218	BBDRACS	94

F 17000 K SERIE		
F 17003 K	NRBS	128
F 17031 K	NRBS	128
F 17032 K	NRBS	128
F 17033 K	NRBS	128
F 17034 K	NRBS	128
F 17035 K	NRBS	128
F 17038 K	NRBS	128
F 17039 K	NRBS	128
F 17040 K	NRBS	128
F 17041 K	NRBS	128
F 17043 K	NRBS	128
F 17044 K	NRBS	128
F 17045 K	NRBS	128
F 17046 K	NRBS	128
F 17051 K	NRBS	128
F 17052 K	NRBS	128
F 17053 K	NRBS	128

Fersa		PG.
F 17054 K	NRBS	128
F 17056 K	NRBS	128
F 17057 K	NRBS	130
F 17058 K	NRBS	130
F 17059 K	NRBS	130
F 17060 K	NRBS	130
F 17061 K	NRBS	130
F 17062 K	NRBS	130
F 17063 K	NRBS	130
F 17064 K	NRBS	130
F 17076 K	NRBS	130
F 17077 K	NRBS	130
F 17078 K	NRBS	130
F 17079 K	NRBS	130
F 17080 K	NRBS	130
F 17089 K	NRBS	130
F 17090 K	NRBS	130
F 17091 K	NRBS	130
F 17092 K	NRBS	130
F 17093 K	NRBS	130
F 17094 K	NRBS	130
F 17095 K	NRBS	130
F 17096 K	NRBS	130
F 17097 K	NRBS	130
F 17098 K	NRBS	130
F 17099 K	NRBS	130
F 17100 K	NRBS	132
F 17101 K	NRBS	132
F 17102 K	NRBS	132
F 17103 K	NRBS	132
F 17104 K	NRBS	132
F 17105 K	NRBS	132
F 17106 K	NRBS	132
F 17107 K	NRBS	132
F 17108 K	NRBS	132
F 17109 K	NRBS	132
F 17110 K	NRBS	132
F 17111 K	NRBS	132
F 17112 K	NRBS	132
F 17113 K	NRBS	132
F 17114 K	NRBS	132

F 18000 SERIE

F 18009	BBS	76
F 18011	BBS	76
F 18012	BBC	106
F 18013	BBC	106
F 18015	BBS	76
F 18018	BBS	76
F 18019	BBS	76
F 18020	BBS	76
F 18021	BBS	76
F 18022	BBS	76
F 18023	BBS	76
F 18024	BBS	76

Fersa		PG.
F 18031	BBC	106
F 18032	BBS	76
F 18033	BBS	76
F 18036	BBS	76
F 18037	BBS	76
F 18038	BBS	76
F 18039	BBS	76
F 18040	BBC	106
F 18041	BBS	76
F 18042	BBS	76
F 18043	BBS	76
F 18046 2RS	BBS	76
F 18046 ZZ	BBS	78
F 18047	BBS	78
F 18048	BBS	78
F 18049	BBS	78
F 18050	BBS	78
F 18051	BBS	78
F 18052	BBS	78
F 18053	BBS	78
F 18054	BBS	78
F 18055	BBS	78
F 18056	BBS	78
F 18058	BBS	78
F 18059	BBS	78
F 18060	BBS	78
F 18062	BBS	78
F 18066	BBS	78
F 18067	BBS	78

F 19000 SERIE

F 19001	CRBS	118
F 19002	CRBS	118
F 19003	CRBS	118
F 19004	CRBS	118
F 19005	CRBS	118
F 19006	CRBS	118
F 19008	CRBS	118
F 19009	CRBS	118
F 19010	CRBS	118
F 19011	CRBS	118
F 19012	CRBS	118
F 19013	CRBS	118
F 19014	CRBS	118
F 19015	CRBS	118
F 19016	CRBS	118
F 19019	CRBS	118
F 19020	CRBS	118
F 19022	CRBS	118
F 19023	CRBS	118
F 19024	CRBS	118
F 19025	CRBS	118
F 19026	CRBS	118
F 19029	CRBS	118
F 19030	CRBS	120

14.1 \ Fersa special part number numerical list

Lista numérica de referencias especiales de Fersa

Fersa		PG.
F 19031	CRBS	120
F 19032	CRBS	120
F 19033	CRBS	120
F 19034	CRBS	120
F 19035	CRBS	120
F 19037	CRBS	120
F 19038	CRBS	120
F 19039	CRBS	120
F 19040	CRBS	120
F 19042	CRBS	120
F 19043	CRBS	120
F 19044	CRBS	120
F 19045	CRBS	120
F 19046	CRBS	120
F 19047	CRBS	120
F 19048	CRBS	120
F 19055	CRBS	120
F 19061	CRBS	120
F 19062	CRBS	120
F 19063	CRBS	120
F 19064	CRBS	120
F 19065	CRBS	120
F 19066	CRBS	120
F 19067	CRBS	120
F 19068	CRBS	120
F 19069	CRBS	120
F 19070	CRBS	122
F 19071	CRBS	122
F 19075	CRBS	122
F 19076	CRBS	122
F 19077	CRBS	122
F 19078	CRBS	122
F 19079	CRBS	122
F 19080	CRBS	122
F 19081	CRBS	122
F 19083	CRBS	122
F 19084	CRBS	122
F 19085	CRBS	122
F 19086	CRBS	122
F 19087	CRBS	122
F 19088	CRBS	122
F 19089	CRBS	122
F 19090	CRBS	122
F 19091	CRBS	122
F 19093	CRBS	122
F 19094	CRBS	122
F 19095	CRBS	122
F 19096	CRBS	122
F 19097	CRBS	122
F 19099	CRBS	122
F 19100	CRBS	122
F 19101	CRBS	122
F 19105	CRBS	124
F 19106	CRBS	124
F 19107	CRBS	124

Fersa		PG.
F 19108	CRBS	124
F 19111	CRBS	124
F 19112	CRBS	124
F 19116	CRBS	124
F 19117	CRBS	124
F 19118	CRBS	124
F 19119	CRBS	124
F 19120	CRBS	124
F 19121	CRBS	124

F 200000 SERIE		
F 200004	WK	138
F 200005	WK	138
F 200013	WK	138
F 200014	WK	138
F 200015	WK	138
F 200016	WK	138
F 200017	WK	140
F 200018	WK	140
F 200019	WK	140
F 200025	WK	140
F 200028	WK	140
F 200029	WK	140
F 200031	WK	140
F 200032	WK	140

F 300000 SERIE		
F 300001	WM	142
F 300003	WM	142
F 300005	WM	142
F 300006	WM	142
F 300007	WM	142
F 300010	WM	142

F 400000 SERIE		
F 400001	PHA	144
F 400002	PHA	144
F 400003	PHA	144
F 400004	PHA	144
F 400006	PHA	144
F 400007	PHA	144
F 400008	PHA	144
F 400009	PHA	144
F 400010	PHA	144
F 400011	PHA	144
F 400013	PHA	144
F 400014	PHA	144
F 400015	PHA	144
F 400016	PHA	146
F 400018	PHA	146
F 400019	PHA	146
F 400021	PHA	146
F 400022	PHA	146
F 400023	PHA	146
F 400029	PHA	146

Fersa		PG.
F 400030	PHA	146
F 400031	PHA	146
F 400032	PHA	146
F 400034	PHA	146



Handwriting practice area consisting of multiple horizontal dotted lines for text entry.

14.2\ Fersa dimensional list

Lista dimensional Fersa

d	D	T	FERSA		PG.
-	44,450	9,525	6	TRBSt	46
-	49,146	19,050	6 CE	TRBSt	46
-	49,225	11,509	13 C	TRBSt	46
-	54,600	22,000	F 19005	CRBS	118
-	55,000	20,000	F 19079	CRBS	122
-	57,092	17,094	14 XS	TRBSt	46
-	62,000	16,000	F 19068	CRBS	120
-	80,000	26,500	F 19069	CRBS	120
-	100,000	25,000	F 19117	CRBS	124
6,000	19,000	6,000	626	BB	64
7,000	19,000	6,000	607	BB	64
8,000	22,000	7,000	608	BB	64
8,000	24,000	8,000	628	BB	64
9,000	24,000	7,000	609	BB	64
9,000	26,000	8,000	629	BB	64
10,000	26,000	8,000	6000	BB	64
10,000	30,000	9,000	6200	BB	67
10,000	35,000	11,000	6300	BB	70
12,000	28,000	8,000	6001	BB	64
12,000	32,000	10,000	6201	BB	67
12,000	32,000	14,000	62201	BB	70
12,000	32,000	10,000 / 15,350	F 18046 2RS	BBS	76
12,000	32,000	10,000 / 15,350	F 18046 ZZ	BBS	78
12,000	37,000	12,000	6301	BB	70
12,000	40,000	12,000	6203/12	BB	67
12,200	36,600	11,000	F 15034	BBT	104
15,000	32,000	9,000	6002	BB	64
15,000	35,000	11,000	6202	BB	67
15,000	35,000	11,000	NU 202 FM/C3	CRB	114
15,000	35,000	11,750	30202 F	TRBM	8
15,000	35,000	13,000	F 18015	BBS	76
15,000	35,000	14,000	62202	BB	70
15,000	42,000	13,000	6302	BB	70
15,000	42,000	14,250	30302 F	TRBM	8
15,000	47,000	14,000	6303/15	BB	71
15,875	42,862	14,288	11590/11520	TRBI	20
15,875	47,000	14,000	F 19055	CRBS	120
15,987	46,975	21,000	HM 81649/ HM 81610	TRBI	27
16,300	56,000	9,000	F 15052	BBC	106
16,993	47,000	14,382	05066/05185	TRBI	19
17,000	35,000	10,000	6003	BB	64
17,000	40,000	12,000	6203	BB	67
17,000	40,000	13,250	30203 F	TRBM	8

d	D	T	FERSA		PG.
17,000	47,000	14,000	6303	BB	71
17,000	47,000	15,250	30303 F	TRBM	8
17,000	47,000	15,250	31303 F	TRBM	9
17,000	52,000	15,000	6304/17	BB	71
17,000	52,000	16,000	6304/17 B16	BB	71
17,000	52,000	17,000	6304/17 B17	BB	71
17,000	62,000	17,000	6403	BB	73
17,000	62,000	17,000 / 17,600	F 18020	BBS	76
17,462	39,878	13,843	LM 11749/ LM 11710	TRBI	20
19,050	39,992	12,014	A 6075/A 6157	TRBI	19
19,050	44,450	12,700	4 A/6	TRBI	14
19,050	45,237	15,494	LM 11949 RS/ LM 11910	TRBI	20
19,050	45,237	15,494	LM 11949/ LM 11910	TRBI	20
19,050	49,225	18,034	09067/09195	TRBI	20
19,050	49,225	19,845	09074/09195	TRBI	20
19,050	49,225	21,209	09067/09196	TRBI	20
19,050	49,225	23,020	09074/09194	TRBI	20
19,050	49,225	23,020	09074/09196	TRBI	20
19,050	53,975	22,225	21075/21212	TRBI	22
20,000	37,000	9,000	61904	BB	66
20,000	42,000	12,000	6004	BB	65
20,000	42,000	15,000	32004 XF	TRBM	9
20,000	42,000	15,000	32004 XR	TRBM	9
20,000	47,000	14,000	6204	BB	67
20,000	47,000	15,250	30204 F	TRBM	8
20,000	47,000	18,000	62204	BB	70
20,000	47,000	19,250	32204 F	TRBM	10
20,000	47,000	19,250	32204 FR	TRBM	10
20,000	52,000	12,000	6304 B12	BB	71
20,000	52,000	15,000	6304	BB	71
20,000	52,000	15,000	NUP 304 FM/ C3	CRB	115
20,000	52,000	16,250	30304 F	TRBM	8
20,000	52,000	19,250	F 15199	TRBS	36
20,000	52,000	21,000	62304	BB	70
20,000	52,000	22,250	32304 F	TRBM	11
20,000	56,000	12,000	6304 B12 D56	BB	71
20,000	72,000	19,000	6404	BB	73
20,625	49,225	19,845	09081/09195	TRBI	20
20,625	49,225	23,020	09081/09196	TRBI	20
21,430	45,237	15,494	LM 12748/ LM 12710	TRBI	20
21,430	50,005	17,026	M 12649 F/ M 12610 F	TRBI	20

d	D	T	FERSA		PG.
21,430	50,005	17,526	M 12649/ M 12610	TRBI	20
21,986	45,000	6,500	F 15108	TRBF	42
21,986	45,237	15,494	LM 12749/ LM 12710	TRBI	20
21,986	45,974	15,494	LM 12749/ LM 12711	TRBI	20
22,000	41,000	14,500	F 15028	TRBS	32
22,000	44,000	15,000	320/22 XF	TRBM	9
22,000	47,000	20,750	F 15063	TRBS	32
22,000	47,000	20,750	F 15089	TRBS	34
22,000	50,000	14,000	62/22	BB	67
22,000	56,000	16,000	63/22	BB	70
22,000	62,000	21,000	F 18067	BBS	78
22,225	50,800	15,011	07087 X/ 07210 X	TRBI	20
22,225	50,800	15,011	07087/ 07210 X	TRBI	19
22,225	51,994	15,011	07087/07204	TRBI	19
22,225	52,388	19,368	1380/1328	TRBI	17
22,225	57,150	22,225	1280/1220	TRBI	17
23,812	56,896	19,368	1779/1729 X	TRBI	17
24,000	-	17,000	F 19032	CRBS	120
24,000	-	28,500	CONE F 15084	CONE	48
24,054	48,021	15,088	T 94	TRBT	60
25,000	47,000	12,000	6005	BB	65
25,000	47,000	15,000	32005 XF	TRBM	9
25,000	47,000	15,000	32005 XR	TRBM	9
25,000	51,400	13,200	F 15339	TRBS	40
25,000	51,994	15,011	07097/07204	TRBI	20
25,000	52,000	15,000	6205	BB	67
25,000	52,000	16,250	30205 F	TRBM	8
25,000	52,000	16,250	30205 FR	TRBM	8
25,000	52,000	16,300	F 15337	TRBS	40
25,000	52,000	18,000	62205	BB	70
25,000	52,000	18,000	F 19023	CRBS	118
25,000	52,000	18,000	NJ 2205 FM/ C3	CRB	114
25,000	52,000	18,000	NUP 2205 FM/ C3	CRB	116
25,000	52,000	19,250	32205 BF	TRBM	10
25,000	52,000	19,250	32205 F	TRBM	10
25,000	52,000	21,000	F 19029	CRBS	118
25,000	52,000	22,000	33205 F	TRBM	13
25,000	52,000	31,000	GRAE 25 NPPB	IB	110
25,000	52,000	37,000	F 15041	TRBDR	52
25,000	52,000	37,000	F 15050	TRBDR	52
25,000	52,000	42,000	F 16129	BBDRACS	92

d	D	T	FERSA		PG.
25,000	52,000	43,000	F 15042	TRBDR	52
25,000	52,000	44,500	GE 25 KRRB	IB	110
25,000	52,000	18,000 / 20,600	F 19004	CRBS	118
25,000	54,000	9,250	F 15196	TRBF	42
25,000	55,000	13,750	F 15315	TRBS	38
25,000	55,000	13,750	F 15336	TRBS	38
25,000	55,000	15,000	F 18058	BBS	78
25,000	55,000	43,000	F 15043	TRBDR	52
25,000	55,000	45,000	F 15175	TRBDR	54
25,000	56,000	12,000	6205 B12 D56	BB	67
25,000	56,000	32,000	F 16004	BBDRACS	82
25,000	57,000	18,000	F 19093	CRBS	122
25,000	59,000	4,100	F 15090	TRBF	42
25,000	59,000	17,500	F 18019	BBS	76
25,000	62,000	17,000	6305	BB	71
25,000	62,000	17,000	NJ 305 F	CRB	114
25,000	62,000	17,250	F 15313	TRBS	38
25,000	62,000	18,250	30305 F	TRBM	8
25,000	62,000	18,250	31305 F	TRBM	9
25,000	62,000	18,250	F 15001	TRBS	32
25,000	62,000	19,000	F 18062	BBS	78
25,000	62,000	24,000	62305	BB	70
25,000	62,000	25,250	32305 F	TRBM	11
25,000	62,000	17,000 / 19,000	F 19040	CRBS	120
25,000	62,020	17,500	F 18018	BBS	76
25,000	66,000	22,050	F 15316	TRBS	38
25,000	69,000	20,000	F 18022	BBS	76
25,000	72,000	19,000	6306/25	BB	71
25,000	80,000	21,000	6405	BB	73
25,400	33,338	25,400	F 17114 K	NRBS	132
25,400	50,005	13,495	07100 S/07196	TRBI	20
25,400	50,005	13,495	07100/07196	TRBI	20
25,400	50,292	14,224	L 44643 RS/ L 44610	TRBI	25
25,400	50,292	14,224	L 44643/ L 44610	TRBI	25
25,400	50,800	15,011	07100 S/ 07210 X	TRBI	20
25,400	51,994	15,011	07100/07204	TRBI	20
25,400	56,896	19,368	1780/1729	TRBI	17
25,400	57,150	17,462	15578/15520	TRBI	22
25,400	57,150	19,431	M 84548/ M 84510	TRBI	27
25,400	58,738	19,050	1986/1932	TRBI	17
25,400	59,530	23,368	M 84249/ M 84210	TRBI	27

14.2\ Fersa dimensional list

Lista dimensional Fersa

d	D	T	FERSA		PG.
25,400	60,325	19,845	1986/1931	TRBI	17
25,400	62,000	19,050	15100/15245	TRBI	21
25,400	62,000	19,050	15101/15245	TRBI	21
25,400	63,500	20,638	15100/15250	TRBI	21
25,400	63,500	20,638	15100/15250 X	TRBI	21
25,400	63,500	20,638	15101/15250	TRBI	21
25,400	63,500	20,638	15101/15250 X	TRBI	21
25,654	50,800	15,875	T 101	TRBT	60
25,987	51,986	15,011	L 44645/ L 44613	TRBI	25
25,987	57,150	17,462	15579 X/15520	TRBI	22
25,995	68,000	14,500 / 21,550	F 18024	BBS	76
26,000	61,000	19,000	15103/15243	TRBI	21
26,162	61,912	19,050	15103 S/15243	TRBI	21
26,162	62,000	19,050	15103 S/15245	TRBI	21
26,988	50,292	14,224	F 15308	TRBS	38
26,988	50,292	14,224	L 44649/ L 44610	TRBI	25
26,988	57,150	17,462	15580/15520	TRBI	22
26,988	62,000	19,050	15106/15245	TRBI	21
26,988	63,500	20,638	15106/15250	TRBI	21
26,988	63,500	20,638	15106/15250 X	TRBI	22
27,000	51,400	13,200	F 15342	TRBS	40
27,000	52,000	45,000 / 50,000	F 15151	TRBDR	52
27,000	53,000	43,000	F 15128	TRBDR	52
27,000	66,000	6,700	F 15312	TRBF	42
27,000	134,000	67,600 / 50,000	F 16094	BBDRACS	90
28,000	-	32,000	CONE F 15101	CONE	48
28,000	52,000	15,750	F 15056	TRBS	32
28,000	52,000	16,000	320/28 XF	TRBM	9
28,000	55,000	13,750	F 15338	TRBS	40
28,000	57,150	17,462	J 15585/15520	TRBI	22
28,000	61,000	42,000	F 16077	BBDRACS	88
28,000	66,000	18,000	F 18021	BBS	76
28,000	68,000	18,000	63/28	BB	70
28,000	68,000	19,750	303/28 F	TRBM	8
28,000	75,000	21,000	F 18043	BBS	76
28,000	119,000	52,000 / 42,000	F 16095	BBDRACS	90
28,000	120,000	63,500	F 16210	BBDRACS	94
28,313	-	-	5 BC	TRBSt	46
28,500	47,600	32,000	F 19095	CRBS	122
28,575	56,896	19,845	1985/1930	TRBI	17
28,575	57,150	19,845	1985/1922	TRBI	17

d	D	T	FERSA		PG.
28,575	57,150	19,845	1988/1922	TRBI	17
28,575	58,738	19,050	1985/1932	TRBI	17
28,575	60,325	19,845	1985/1931	TRBI	17
28,575	60,325	19,845	1988/1931	TRBI	17
28,575	62,000	19,050	15112/15245	TRBI	22
28,575	63,500	20,638	15112/15250	TRBI	22
28,575	63,500	20,638	15112/15250 X	TRBI	22
28,575	64,292	21,432	M 86647/ M 86610	TRBI	27
28,575	66,421	23,812	2689/2631	TRBI	17
28,575	68,262	22,225	02474/02420	TRBI	19
28,575	71,438	20,638	RMS 9	BB	75
28,575	72,626	24,608	41125/41286	TRBI	25
28,575	73,025	22,225	02872/02820	TRBI	19
28,575	79,375	25,400	43112/43312	TRBI	25
28,829	55,562	15,875	T 113	TRBT	60
29,000	50,292	14,224	F 15029	TRBS	32
29,000	50,292	14,224	L 45449/ L 45410	TRBI	25
29,000	53,000	37,000	F 15067	TRBDR	52
29,987	62,000	19,050	15117/15245	TRBI	22
30,000	-	23,000	F 19075	CRBS	122
30,000	-	23,812	F 19118	CRBS	124
30,000	-	26,000	F 19019	CRBS	118
30,000	52,000	22,000	F 16097	AIR	100
30,000	55,000	13,000	6006	BB	65
30,000	55,000	17,000	32006 XF	TRBM	9
30,000	55,000	20,000	33006 F	TRBM	12
30,000	55,000	23,000	F 16098	AIR	100
30,000	55,500	7,000	F 15311	TRBF	42
30,000	59,000	13,000 / 15,000	F 19024	CRBS	118
30,000	60,030	37,000	F 16001	BBDRACS	82
30,000	61,935	19,050	F 19031	CRBS	120
30,000	61,935	23,813	F 19045	CRBS	120
30,000	62,000	16,000	6206	BB	68
30,000	62,000	16,000	N 206 FM	CRB	114
30,000	62,000	16,000	NU 206 FM	CRB	114
30,000	62,000	16,000	NUP 206 FM	CRB	115
30,000	62,000	17,250	30206 F	TRBM	8
30,000	62,000	18,000	32007 X 30/32007 XF	TRBM	9
30,000	62,000	20,000	62206	BB	70
30,000	62,000	20,000	F 15309	TRBS	38
30,000	62,000	20,000	F 19025	CRBS	118
30,000	62,000	21,250	32206 F	TRBM	10
30,000	62,000	23,800	3206 B 2RS/C3	BBDRAC	96

d	D	T	FERSA		PG.
30,000	62,000	24,000	F 19096	CRBS	122
30,000	62,000	25,000	33206 F	TRBM	13
30,000	62,000	27,000	F 16104	AIR	100
30,000	62,000	35,800	GRAE 30 NPPB	IB	110
30,000	62,000	48,000	F 15360	TRBS	54
30,000	62,000	48,500	GE 30 KRRB	IB	110
30,000	65,000	21,000	F 18011	BBS	76
30,000	69,012	19,845	14118/14274	TRBI	21
30,000	72,000	19,000	6306	BB	71
30,000	72,000	19,000	F 19091	CRBS	122
30,000	72,000	19,000	NJ 306 FM	CRB	114
30,000	72,000	20,750	30306 F	TRBM	8
30,000	72,000	20,750	31306 F	TRBM	9
30,000	72,000	20,750	F 15002	TRBS	32
30,000	72,000	24,000	F 15203	TRBS	36
30,000	72,000	27,000	62306	BB	70
30,000	72,000	27,000	NU 2306 F	CRB	115
30,000	72,000	27,000	NU 2306 F/C3	CRB	115
30,000	72,000	27,000	NU 2306 FM/C3	CRB	115
30,000	72,000	28,750	32306 BF	TRBM	11
30,000	72,000	28,750	32306 C	TRBM	11
30,000	72,000	28,750	32306 F	TRBM	11
30,000	72,000	29,370	JHM 88540/ JHM 88513	TRBI	27
30,000	72,085	22,385	14118/14283	TRBI	21
30,000	75,000	21,000	F 18047	BBS	78
30,000	80,000	21,000	F 19078	CRBS	122
30,000	80,000	21,000	F 19083	CRBS	122
30,000	80,000	26,000	F 19120	CRBS	124
30,000	90,000	23,000	6406	BB	73
30,000	90,000	23,000	NJ 406 FM/C3	CRB	114
30,000	117,000	61,300 / 37,000	F 16010	BBDRACS	82
30,000	120,000	63,500	F 16209	BBDRACS	94
30,162	64,292	21,432	M 86649/ M 86610	TRBI	27
30,162	68,262	8,730	M 88043/ M 88010 B	TRBF	42
30,162	68,262	22,225	M 88043/ M 88010	TRBI	27
30,162	68,262	22,225	M 88043/ M 88011	TRBI	27
30,213	62,000	19,050	15118/15245	TRBI	22
30,213	63,500	20,638	15118/15250	TRBI	22
30,213	63,500	20,638	15118/15250 X	TRBI	22
30,226	69,012	19,845	14116/14276	TRBI	20
30,416	55,562	15,875	T 119	TRBT	60

d	D	T	FERSA		PG.
30,955	64,292	21,432	M 86648 A/ M 86610	TRBI	27
31,750	58,877	15,875	LM 67048/ LM 67010 BA	TRBF	26
31,750	59,131	6,375	LM 67048/ LM 67010 BCE	TRBF	42
31,750	59,131	15,875	LM 67048 RS/ LM 67010	TRBI	26
31,750	59,131	15,875	LM 67048/ LM 67010	TRBI	26
31,750	59,131	15,875	LM 67049 A/ LM 67010	TRBI	26
31,750	61,986	15,875	LM 67048/ LM 67014	TRBI	26
31,750	61,986	15,875	LM 67048/ LM 67014 X	TRBI	26
31,750	61,986	15,875	LM 67049 A/ LM 67014	TRBI	27
31,750	62,000	7,938	F 15198	TRBF	42
31,750	62,000	18,161	15123/15245	TRBI	22
31,750	62,000	19,050	15126/15245	TRBI	22
31,750	62,000	19,749	15123/15244	TRBI	22
31,750	63,500	19,749	15123/15250 X	TRBI	22
31,750	63,500	20,638	15126/15250 X	TRBI	22
31,750	66,421	25,400	2580/2520	TRBI	17
31,750	68,262	22,225	02475/02420	TRBI	19
31,750	68,262	22,225	M 88046/ M 88010	TRBI	27
31,750	69,012	19,845	14125 A/14274	TRBI	21
31,750	69,012	19,845	14125 A/14276	TRBI	21
31,750	69,012	26,983	14123 AA/ 14274	TRBI	21
31,750	69,012	26,983	14123 AA/ 14276	TRBI	21
31,750	69,850	23,812	2580/2523	TRBI	17
31,750	72,085	22,385	14125 A/14283	TRBI	21
31,750	73,025	29,370	HM 88542/ HM 88510	TRBI	27
32,000	-	29,500	CONE F 15110	CONE	48
32,000	-	33,000	CONE F 15213	CONE	48
32,000	40,000	49,200	F 17078 K	NRBS	130
32,000	53,000	14,500	JL 26749 F/ JL 26710	TRBI	23
32,000	55,000	13,000	6006/32	BB	65
32,000	58,000	17,000	320/32 XF	TRBM	9
32,000	58,000	17,000	320/32 XR	TRBM	9
32,000	75,000	20,000	63/32	BB	70
32,000	80,000	23,000	F 18048	BBS	78
32,004	55,562	15,875	T 126	TRBT	60
33,000	72,000	17,000	6207/33	BB	68

14.2\ Fersa dimensional list

Lista dimensional Fersa

d	D	T	FERSA		PG.
33,297	-	-	11 BC	TRBSt	46
33,337	88,500	25,400	44131/44348	TRBI	25
33,338	66,675	20,638	1680/1620	TRBI	17
33,338	68,262	22,225	M 88048/ M 88010	TRBI	27
33,338	69,012	19,845	14130/14274	TRBI	21
33,338	69,012	19,845	14130/14276	TRBI	21
33,338	69,012	19,845	14131/14274	TRBI	21
33,338	69,012	19,845	14131/14276	TRBI	21
33,338	69,850	23,812	2585/2523	TRBI	17
33,338	73,025	29,370	HM 88547/ HM 88510	TRBI	28
33,338	76,200	29,370	HM 89443/ HM 89410	TRBI	28
33,338	76,200	29,370	HM 89443/ HM 89411	TRBI	28
33,338	79,375	29,370	3477/3420	TRBI	18
34,000	62,000	18,000	32007 X 34/32007 XF	TRBM	10
34,000	62,000	37,000	F 16018	BBDRACS	82
34,000	64,000	37,000	F 16019	BBDRACS	82
34,000	66,000	37,000	F 16020	BBDRACS	82
34,000	67,000	37,000	F 16083	BBDRACS	88
34,925	65,088	18,034	LM 48548 RS/ LM 48510	TRBI	26
34,925	65,088	18,034	LM 48548/ LM 48510	TRBI	26
34,925	68,262	18,034	LM 48548/ LM 48514 XP	TRBI	26
34,925	68,262	20,638	14585/14525	TRBI	21
34,925	69,012	19,845	14137 A/14274	TRBI	21
34,925	69,012	19,845	14137 A/14276	TRBI	21
34,925	69,012	19,845	14137 AS/ 14276	TRBI	21
34,925	69,012	19,845	14138 A/14274	TRBI	21
34,925	69,012	19,845	14138 A/14276	TRBI	21
34,925	69,012	26,983	14136 A/14276	TRBI	21
34,925	72,085	22,385	14138 A/14283	TRBI	21
34,925	72,233	25,400	HM 88649/ HM 88610	TRBI	28
34,925	73,025	23,812	25877/25820	TRBI	23
34,925	73,025	23,812	25877/25821	TRBI	23
34,925	73,025	23,812	25878/25820	TRBI	23
34,925	73,025	23,812	F 15384	TRBS	40
34,925	73,025	26,988	23690/23620	TRBI	22
34,925	73,025	26,988	F 15080	TRBS	34
34,925	76,200	29,370	31593/31520	TRBI	24
34,925	76,200	29,370	31594/31520	TRBI	24

d	D	T	FERSA		PG.
34,925	76,200	29,370	HM 89446/ HM 89410	TRBI	28
34,925	79,375	29,370	3478/3420	TRBI	18
34,925	80,035	21,433	28137/28317	TRBI	23
34,925	85,725	30,162	3872/3820	TRBI	18
34,987	59,131	15,875	L 68149 R/ L 68110	TRBI	27
34,987	59,131	15,875	L 68149/ L 68110	TRBI	27
34,987	59,975	15,875	L 68149/ L 68111	TRBI	27
34,987	61,975	16,700	LM 78349/ LM 78310 A	TRBI	27
34,987	64,975	18,100	U 298/U 261 L	U Series	44
34,987	65,088	15,875	L 68149/ L 68116	TRBI	27
34,993	80,000	23,000	F 19043	CRBS	120
35,000	-	25,000	F 19037	CRBS	120
35,000	50,000	20,000	F 16099	AIR	100
35,000	52,000	22,000	F 16101	AIR	100
35,000	55,000	20,000	F 16100	AIR	100
35,000	60,000	13,000	F 15040	TRBS	32
35,000	60,000	15,875	F 15036	TRBS	32
35,000	60,000	15,875	JL 68145/ JL 68111 Z	TRBI	27
35,000	62,000	14,000	6007	BB	65
35,000	62,000	18,000	32007 XF	TRBM	10
35,000	62,000	18,000	32007 XR	TRBM	10
35,000	62,000	16,700 / 19,000	F 19066	CRBS	120
35,000	64,000	37,000	F 16200	BBDRACS	92
35,000	65,000	35,000	F 15044	TRBDR	52
35,000	65,000	35,000	F 16021	BBDRACS	82
35,000	65,000	35,000	F 15381	TRBS	40
35,000	66,000	32,000	F 16022	BBDRACS	82
35,000	66,000	33,000	F 16093	BBDRACS	90
35,000	66,000	37,000	F 16023	BBDRACS	82
35,000	68,000	37,000	F 16002	BBDRACS	82
35,000	68,000	48,000	F 15173	TRBDR	54
35,000	72,000	17,000	6207	BB	68
35,000	72,000	18,250	30207 F	TRBM	8
35,000	72,000	20,600	F 19035	CRBS	120
35,000	72,000	23,000	62207	BB	70
35,000	72,000	23,000	NU 2207 FM	CRB	115
35,000	72,000	24,000	F 15197	TRBS	36
35,000	72,000	24,250	32207 F	TRBM	10
35,000	72,000	26,988	F 19086	CRBS	122
35,000	72,000	27,000	3207 B 2RS/C3	BBDRAC	96

d	D	T	FERSA		PG.
35,000	72,000	28,000	33207 F	TRBM	13
35,000	72,000	33,000	F 16026	BBDRACS	82
35,000	72,000	33,000	F 16204	BBDRACS	94
35,000	72,000	34,000	F 16201	BBDRACS	92
35,000	72,000	39,000	GRAE 35 NPPB	IB	110
35,000	72,000	51,300	GE 35 KRRB	IB	110
35,000	72,040	33,000	F 16027	BBDRACS	82
35,000	75,000	20,000	F 18023	BBS	76
35,000	75,000	60,000	F 15317	TRBS	54
35,000	80,000	18,250	30207/80 F	TRBM	8
35,000	80,000	21,000	6307	BB	71
35,000	80,000	21,000	F 19077	CRBS	122
35,000	80,000	21,000	F 19100	CRBS	122
35,000	80,000	21,000	N 307 FM	CRB	114
35,000	80,000	21,000	NUP 307 FP/ C3	CRB	115
35,000	80,000	22,000	F 19020	CRBS	118
35,000	80,000	22,750	30307 F	TRBM	8
35,000	80,000	22,750	31307 F	TRBM	9
35,000	80,000	22,750	F 15014	TRBS	32
35,000	80,000	23,000	6307 B23	BB	71
35,000	80,000	23,000	F 19012	CRBS	118
35,000	80,000	26,000	F 19099	CRBS	122
35,000	80,000	31,000	NU 2307 F	CRB	115
35,000	80,000	31,000	NU 2307 F/C3	CRB	115
35,000	80,000	31,000	NU 2307 FM/ C3	CRB	115
35,000	80,000	32,750	32307 F	TRBM	11
35,000	80,000	34,900	3307 B 2RS/C3	BBDRAC	96
35,000	89,000	38,000	F 15202	TRBS	36
35,000	90,000	23,000	F 19084	CRBS	122
35,000	100,000	25,000	6407	BB	74
35,179	58,738	15,875	T 139	TRBT	60
35,179	66,675	19,446	T 138	TRBT	60
35,717	72,233	25,400	HM 88648/ HM 88610	TRBI	28
36,000	-	20,000	F 19048	CRBS	120
36,000	66,000	35,000	F 16211	BBDRACS	94
36,000	68,000	33,000	F 16115	BBDRACS	90
36,487	68,000	15,000	F 18038	BBS	76
36,487	73,025	23,812	25880/25820	TRBI	23
36,487	73,025	23,812	25880/25821	TRBI	23
36,487	76,200	23,812	2780/2720	TRBI	17
36,487	76,200	23,812	2780/2729	TRBI	17
36,512	76,200	29,370	HM 89448/ HM 89410	TRBI	28

d	D	T	FERSA		PG.
36,512	76,200	29,370	HM 89449/ HM 89410	TRBI	28
36,512	85,725	30,162	3878/3820	TRBI	18
36,513	68,000	15,000	F 18039	BBS	76
36,754	66,675	19,446	T 144	TRBT	60
37,000	57,000	31,000	F 19090	CRBS	122
37,000	72,000	18,250	30207/37 F	TRBM	8
37,000	72,000	33,000	F 16029	BBDRACS	82
37,000	72,000	37,000	F 16030	BBDRACS	84
37,000	72,040	37,000	F 16031	BBDRACS	84
37,000	74,000	45,000	F 16032	BBDRACS	84
37,000	80,000	26,500	F 19116	CRBS	124
37,000	139,000	64,000 / 45,000	F 16033	BBDRACS	84
37,990	74,020	33,000 / 36,000	F 16034	BBDRACS	84
38,000	46,000	32,000	F 17105 K	NRBS	132
38,000	63,000	17,000	JL 69345/ JL 69310 Z	TRBI	27
38,000	63,000	17,000	JL 69349/ JL 69310	TRBI	27
38,000	69,000	39,000	F 16218	BBDRACS	94
38,000	70,000	38,000	F 16215	BBDRACS	94
38,000	71,020	33,000/ 33,000	F 16120	BBDRACS	92
38,000	72,000	40,000	F 16124	BBDRACS	92
38,000	72,020	33,000 / 36,000	F 16068	BBDRACS	88
38,000	73,000	40,000	F 16117	BBDRACS	92
38,000	74,000	50,000	F 16058	BBDRACS	88
38,000	83,000	25,400	F 19067	CRBS	120
38,000	89,600	25,400	F 19094	CRBS	122
38,000	90,000	35,250	323/38 F	TRBM	11
38,000	90,000	23,000 / 22,000	F 19014	CRBS	118
38,000	94,000	33,000 / 31,500	F 19076	CRBS	122
38,090	67,300 / 72,500	18,200	F 15091	BBT	104
38,100	-	29,771	CONE F 15131	CONE	48
38,100	65,088	18,034	F 15055/ LM 29710	TRBS	32
38,100	65,088	18,034	LM 29748/ LM 29710	TRBI	24
38,100	65,088	18,034	LM 29749/ LM 29710	TRBI	24
38,100	65,088	19,812	LM 29748/ LM 29711	TRBI	24
38,100	65,088	19,812	LM 29749/ LM 29711	TRBI	24

14.2\ Fersa dimensional list

Lista dimensional Fersa

d	D	T	FERSA		PG.
38,100	68,262	15,875	19150/19268	TRBI	22
38,100	69,010	26,190	13686/13621	TRBI	20
38,100	69,012	19,050	13685/13621	TRBI	20
38,100	69,012	19,050	13687/13620	TRBI	20
38,100	69,012	19,050	13687/13621	TRBI	20
38,100	70,000	37,000	F 16057	BBDRACS	88
38,100	72,238	20,638	16150/16284	TRBI	22
38,100	76,200	23,812	2788/2720	TRBI	17
38,100	76,200	23,812	2788/2729	TRBI	17
38,100	76,200	25,400	26878/26823	TRBI	23
38,100	79,375	29,370	3490/3420	TRBI	18
38,100	80,167	29,370	3381/3320	TRBI	18
38,100	82,550	29,370	HM 801346 X/ HM 801310	TRBI	30
38,100	82,550	29,370	HM 801346/ HM 801310	TRBI	30
38,100	88,500	26,988	418/414	TRBI	15
38,100	90,000	35,250	F 15157	TRBS	34
38,303	65,883	19,431	T 149	TRBT	60
38,354	72,619	20,638	T 152	TRBT	60
38,354	72,619	21,433	T 151	TRBT	60
39,000	68,000	37,000	F 15045	TRBDR	52
39,000	68,000	37,000	F 16035	BBDRACS	84
39,000	72,000	37,000	F 16036	BBDRACS	84
39,000	72,000	37,000	F 16110	BBDRACS	90
39,000	74,000	39,000	F 16037	BBDRACS	84
39,000 / 41,000	75,000	37,000	F 16038	BBDRACS	84
39,100	74,000	34,000	F 16205	BBDRACS	94
39,688	-	40,386	CONE 4367 X	CONE	48
39,688	-	40,386	CONE F 15249	CONE	48
39,688	-	43,050	CONE F 15292	CONE	48
39,688	73,025	19,395	U 399/U 360 L	U Series	44
39,688	76,200	23,812	2789/2720	TRBI	17
39,688	76,200	23,812	2789/2729	TRBI	18
39,688	79,967	19,395	U 399/U 365 L	U Series	44
39,688	79,975	29,370	3386/3325	TRBI	18
39,688	80,167	29,370	3382/3320	TRBI	18
39,688	80,167	29,370	3386/3320	TRBI	18
39,688	80,167	29,370	F 15109	TRBS	34
39,688	90,488	39,688	4367 X/4335	TRBI	19
39,980	108,000	17,000 / 32,000	F 16044	BBDRACS	86
39,987	90,975	32,000	HM 204043/ HM 204010	TRBI	28
40,000	-	29,000	F 19065	CRBS	120
40,000	-	35,000	CONE F 15356	CONE	48

d	D	T	FERSA		PG.
40,000	-	38,000	CONE F 15150 A	CONE	48
40,000	48,000	20,000	F 17106 K	NRBS	132
40,000	57,000	24,000	F 16189	AIR	100
40,000	60,000	3,000	F 17003 K	NRBS	128
40,000	60,000	26,000	F 19111	CRBS	124
40,000	62,000	20,625	F 16103	AIR	100
40,000	62,000	24,000	F 16102	AIR	100
40,000	62,000	20,600 / 24,000	F 16190	AIR	100
40,000	68,000	15,000	6008	BB	65
40,000	68,000	15,000	NU 1008 FM	CRB	115
40,000	68,000	19,000	32008 XF	TRBM	10
40,000	72,000	37,000	F 16039	BBDRACS	84
40,000	73,000	55,000	F 15187	TRBDR	54
40,000	74,000	36,000	F 16080	BBDRACS	88
40,000	74,000	40,000	F 16040	BBDRACS	86
40,000	74,000	40,000	F 16089	BBDRACS	90
40,000	74,000	42,000	F 16079	BBDRACS	88
40,000	74,000	34,000 / 36,000	F 16091	BBDRACS	90
40,000	75,000	8,000	F 15310	TRBF	42
40,000	75,000	26,000	33108 F	TRBM	12
40,000	75,000	37,000	F 16055	BBDRACS	86
40,000	75,000	39,000	F 16217	BBDRACS	94
40,000	75,000	50,000	F 15129	TRBDR	52
40,000	76,000	33,000	F 16198	BBDRACS	92
40,000	76,040	38,000 / 41,000	F 16041	BBDRACS	86
40,000	80,000	7,750	30208 BF	TRBF	42
40,000	80,000	18,000	6208	BB	68
40,000	80,000	18,000	NU 208 FN	CRB	114
40,000	80,000	18,000	NU 208 FMN	CRB	114
40,000	80,000	18,000	NU 208 FMN/C3	CRB	114
40,000	80,000	18,000	QJ 208 FM	BB4PAC	98
40,000	80,000	18,000	QJ 208 FM/C3	BB4PAC	98
40,000	80,000	19,750	30208 F	TRBM	8
40,000	80,000	21,000	344/332	TRBI	14
40,000	80,000	23,000	62208	BB	70
40,000	80,000	24,750	32208 F	TRBM	10
40,000	80,000	30,200	3208 B 2RS/C3	BBDRAC	96
40,000	80,000	30,200	F 16042	BBDRACS	86
40,000	80,000	32,000	33208 F	TRBM	13
40,000	80,000	38,000	F 15149	TRBDR	52
40,000	80,000	38,100	F 16043	BBDRACS	86
40,000	80,000	43,800	GRAE 40 NPPB	IB	110
40,000	80,000	56,500	GE 40 KRRB	IB	110

d	D	T	FERSA		PG.
40,000	80,000	34,000 / 36,000	F 16090	BBDRACS	90
40,000	84,020	38,000	F 16066	BBDRACS	88
40,000	84,060	39,700 / 38,800	F 16108	BBDRACS	90
40,000	85,000	33,000	JF 4049/JF 4010	TRBI	19
40,000	90,000	23,000	6308	BB	72
40,000	90,000	23,000	F 18051	BBS	78
40,000	90,000	23,000	F 19006	CRBS	118
40,000	90,000	23,000	F 19034	CRBS	120
40,000	90,000	23,000	NJ 308 FM	CRB	114
40,000	90,000	23,000	NU 308 FM	CRB	114
40,000	90,000	23,000	NUP 308 FM	CRB	115
40,000	90,000	23,000	NUP 308 FM/C3	CRB	115
40,000	90,000	23,000	NUP 308 FMNR/C3	CRB	115
40,000	90,000	23,000	NUP 308 FP	CRB	115
40,000	90,000	23,000	F 19119	CRBS	124
40,000	90,000	23,000	F 19112	CRBS	124
40,000	90,000	25,000	F 19033	CRBS	120
40,000	90,000	25,250	30308 F	TRBM	9
40,000	90,000	25,250	31308 F	TRBM	9
40,000	90,000	28,750	F 15117	TRBS	34
40,000	90,000	35,250	32308 C	TRBM	11
40,000	90,000	35,250	32308 F	TRBM	11
40,000	90,000	36,500	3308 DP	BBDRAC	96
40,000	90,000	27,000 / 24,900	F 19013	CRBS	118
40,000	94,000	26,000	F 18050	BBS	78
40,000	94,000	30,000	F 19089	CRBS	122
40,000	110,000	27,000	6408	BB	74
40,987	67,975	17,500	F 15003	TRBS	32
40,987	67,975	17,500	LM 300849/LM 300811	TRBI	28
41,000	68,000	35,000 / 40,000	F 15015	TRBDR	52
41,000	73,000	21,000	F 15340	TRBS	40
41,275	73,025	16,667	18590/18520	TRBI	22
41,275	73,431	19,558	LM 501349/LM 501310	TRBI	29
41,275	73,431	21,430	LM 501349/LM 501314	TRBI	29
41,275	76,200	7,292	11163/11300 B	TRBF	42
41,275	76,200	18,009	11162/11300	TRBI	20
41,275	76,200	18,009	11163/11300	TRBI	20
41,275	76,200	22,225	24780/24720	TRBI	22
41,275	76,200	22,225	24781/24720	TRBI	22
41,275	76,200	25,400	24780/24721	TRBI	22

d	D	T	FERSA		PG.
41,275	76,200	25,400	24781/24721	TRBI	22
41,275	79,375	23,812	26882/26822	TRBI	23
41,275	80,000	21,000	336/332	TRBI	14
41,275	80,000	28,574	342 A/332	TRBI	14
41,275	80,167	25,400	26882/26820	TRBI	23
41,275	80,167	29,370	3384/3320	TRBI	18
41,275	82,550	26,543	M 802048/M 802011	TRBI	30
41,275	84,138	30,162	3577/3520	TRBI	18
41,275	85,725	30,162	3877/3820	TRBI	18
41,275	87,312	30,162	3577/3525	TRBI	18
41,275	87,312	30,162	3585/3525	TRBI	18
41,275	88,500	25,400	44162/44348	TRBI	25
41,275	88,500	26,988	419/414	TRBI	15
41,275	88,900	30,162	HM 803146/HM 803110	TRBI	30
41,275	88,900	30,162	HM 803145/HM 803110	TRBI	30
41,275	90,488	39,688	4388/4335	TRBI	19
41,275	93,662	31,750	49162/49368	TRBI	26
41,275	95,250	30,162	HM 804840/HM 804810	TRBI	30
41,275	95,250	30,958	HM 903245/HM 903210	TRBI	31
41,275	104,775	36,512	59162/59412	TRBI	26
41,500	66,000	16,000	F 15004	BBT	104
41,529	72,619	21,433	T 163	TRBT	60
41,530	72,200	21,400	F 15064	BBT	104
42,000	50,000	30,000	F 17093 K	NRBS	130
42,000	50,000	51,000	F 17033 K	NRBS	128
42,000	75,000	37,000	F 16045	BBDRACS	86
42,000	75,000	37,000	F 16046	BBDRACS	86
42,000	76,000	23,812	F 15112	TRBS	34
42,000	76,000	33,000	F 16197	BBDRACS	92
42,000	76,000	39,000	F 16194	BBDRACS	92
42,000	76,000	35,000 / 38,000	F 16081	BBDRACS	88
42,000	76,000	37,000 / 40,000	F 16195	BBDRACS	92
42,000	78,000	45,000	F 16203	BBDRACS	94
42,000	80,000	36,000	F 16207	BBDRACS	94
42,000	80,000	37,000	F 16107	BBDRACS	90
42,000	80,000	38,000	F 15130	TRBDR	52
42,000	80,000	39,000	F 16213	BBDRACS	94
42,000	80,000	45,000	F 16088	BBDRACS	90
42,000	80,000	45,000	F 16214	BBDRACS	94
42,000	82,000	36,000	F 16048	BBDRACS	86

14.2\ Fersa dimensional list

Lista dimensional Fersa

d	D	T	FERSA		PG.
42,000	82,000	40,000	F 15218	TRBDR	54
42,000	84,000	39,000	F 16051	BBDRACS	86
42,000	92,075	24,607	F 15278	TRBS	38
42,070	-	40,386	CONE 4395	CONE	48
42,862	82,931	23,812	25576/25520	TRBI	22
42,862	82,931	23,812	25578/25520	TRBI	23
42,862	82,931	26,988	25578/25523	TRBI	23
42,862	83,058	23,812	25578/25521	TRBI	23
42,862	83,058	23,876	25578/25522	TRBI	23
42,875	76,200	25,400	26884/26823	TRBI	23
42,875	82,931	23,812	25577/25520	TRBI	22
42,875	82,931	26,988	25577/25523	TRBI	22
42,875	83,058	23,812	25577/25521	TRBI	22
42,875	83,058	23,876	25577/25522	TRBI	22
43,000	76,000	43,000	F 16196	BBDRACS	92
43,000	77,000	41,500 / 45,500	F 15160	TRBDR	52
43,000	78,000	44,000	F 16193	BBDRACS	92
43,000	79,000	38,000 / 41,000	F 16052	BBDRACS	86
43,000	80,000	38,000	F 16086	BBDRACS	90
43,000 / 45,000	82,000	37,000	F 16054	BBDRACS	86
43,000	82,000	45,000	F 16078	BBDRACS	88
43,000 / 45,000	85,000	37,000	F 16118	BBDRACS	92
43,655	-	-	35 BC	TRBSt	46
44,000	82,500	37,000	F 16056	BBDRACS	88
44,450	82,931	23,812	25580/25520	TRBI	23
44,450	82,931	23,813	25581/25520	TRBI	23
44,450	82,931	26,988	25580/25523	TRBI	23
44,450	83,058	23,812	25580/25521	TRBI	23
44,450	83,058	23,876	25580/25522	TRBI	23
44,450	84,138	30,162	3578/3520	TRBI	18
44,450	87,312	30,162	3578/3525	TRBI	18
44,450	88,900	30,162	HM 803149/ HM 803110	TRBI	30
44,450	90,119	23,000	355 X/352	TRBI	14
44,450	93,264	30,162	3782/3720	TRBI	18
44,450	93,662	31,750	49175/49368	TRBI	26
44,450	95,250	27,783	33885/33822	TRBI	24
44,450	95,250	30,162	HM 804843/ HM 804810	TRBI	30
44,450	95,250	30,958	53176/53375	TRBI	26
44,450	95,250	30,958	53177/53375	TRBI	26
44,450	95,250	30,958	53178/53375	TRBI	26
44,450	95,250	30,958	53178/53377	TRBI	26

d	D	T	FERSA		PG.
44,450	95,250	30,958	HM 903249/ HM 903210	TRBI	31
44,450	101,600	34,925	527/522	TRBI	15
44,450	104,775	30,162	45280/45220	TRBI	25
44,450	104,775	36,512	59175/59412	TRBI	26
44,450	104,775	36,512	HM 807040/ HM 807010	TRBI	30
44,450	111,125	30,162	55175 C/55437	TRBI	26
44,983	82,931	23,812	25584/25520	TRBI	23
44,983	83,058	23,813	25584/25521	TRBI	23
44,983	93,264	30,162	3776/3720	TRBI	18
44,983	99,995	25,400	25584/ 25547 RB	TRBI	23
44,983	101,600	34,925	527 S/522	TRBI	15
44,983	112,712	34,512	F 15280	TRBS	38
44,987	79,975	24,000	U 497/U 460 L	U Series	44
44,987	82,931	23,812	25584 A/25520	TRBI	23
44,987	104,986	32,512	HM 905843/ HM 905810	TRBI	31
44,990	84,070	39,000	F 16084	BBDRACS	90
45,000	-	30,045	CONE F 15132	CONE	48
45,000	53,000	21,000	F 17054 K	NRBS	128
45,000	57,000	21,000	F 17041 K	NRBS	128
45,000	68,000	12,000	61909	BB	66
45,000	73,000	20,000	T 177	TRBT	60
45,000	75,000	16,000	6009	BB	65
45,000	75,000	20,000	32009 XF	TRBM	10
45,000	75,000	20,000	32009 XR	TRBM	10
45,000	80,000	26,000	33109 F	TRBM	12
45,000	80,000	45,000	F 16085	BBDRACS	90
45,000	84,000	39,000	F 16059	BBDRACS	88
45,000	84,000	39,000	F 16082	BBDRACS	88
45,000	84,000	45,000	F 16216	BBDRACS	94
45,000	85,000	19,000	6209	BB	68
45,000	85,000	19,000	NU 209 FMN	CRB	114
45,000	85,000	19,000	NU 209 FN/C3	CRB	114
45,000	85,000	19,000	NU 209 FMN/C3	CRB	114
45,000	85,000	19,000	NUP 209 FM	CRB	115
45,000	85,000	19,000	QJ 209 FM	BB4PAC	98
45,000	85,000	19,000	QJ 209 FM/C3	BB4PAC	98
45,000	85,000	19,000	F 19121	CRBS	124
45,000	85,000	20,750	30209 F	TRBM	8
45,000	85,000	23,000	F 18009	BBS	76
45,000	85,000	24,750	32209 F	TRBM	10
45,000	85,000	30,200	F 16063	BBDRACS	88
45,000	85,000	32,000	33209 F	TRBM	13
45,000	85,000	43,800	GRAE 45 NPPB	IB	110

d	D	T	FERSA		PG.
45,000	85,000	56,500	GE 45 KRRB	IB	110
45,000	86,000	39,000	F 16123	BBDRACS	92
45,000	86,000	39,000	F 16128	BBDRACS	92
45,000	88,000	16,750	F 15314	TRBS	38
45,000	88,000	17,500	F 15382	TRBS	40
45,000	88,020	39,000	F 16121	BBDRACS	92
45,000	90,000	9,000	JHM 803148/ JHM 803113 B	TRBF	42
45,000	95,000	29,000	JW 4549/ JW 4510	TRBI	19
45,000	95,000	36,000	JF 4549/ JF 4510	TRBI	19
45,000	95,000	28,000 / 32,000	F 19015	CRBS	118
45,000	100,000	25,000	6309	BB	72
45,000	100,000	25,000	F 19002	CRBS	118
45,000	100,000	25,000	F 19003	CRBS	118
45,000	100,000	25,000	F 19044	CRBS	120
45,000	100,000	25,000	F 19085	CRBS	122
45,000	100,000	25,000	NJ 309 FM	CRB	114
45,000	100,000	25,000	NU 309 FM	CRB	114
45,000	100,000	25,000	NU 309 FMN	CRB	114
45,000	100,000	25,000	NU 309 FMNR/ C3	CRB	114
45,000	100,000	25,000	NUP 309 FM	CRB	115
45,000	100,000	25,000	NUP 309 FM/C3	CRB	115
45,000	100,000	25,000	NUP 309 FMN	CRB	115
45,000	100,000	25,000	NUP 309 FN/C3	CRB	115
45,000	100,000	25,000	NUP 309 FP	CRB	115
45,000	100,000	25,000	QJ 309 FM	BB4PAC	98
45,000	100,000	25,000	QJ 309 FM/C3	BB4PAC	98
45,000	100,000	25,000	F 19107	CRBS	124
45,000	100,000	27,250	30309 F	TRBM	9
45,000	100,000	27,250	31309 F	TRBM	9
45,000	100,000	31,000	F 19063	CRBS	120
45,000	100,000	31,000	F 19081	CRBS	122
45,000	100,000	36,000	F 19001	CRBS	118
45,000	100,000	36,000	F 19080	CRBS	122
45,000	100,000	38,250	32309 BF	TRBM	11
45,000	100,000	38,250	32309 F	TRBM	11
45,000	110,000	12,000	F 15161	TRBF	42
45,000	115,000	53,000	F 15154	TRBDR	52
45,000	120,000	29,000	6409	BB	74
45,000	120,000	84,900	F 300006	WM	142
45,230	79,985	19,842	17887/17831	TRBI	22
45,237	79,975	30,162	3586/3525	TRBI	18

d	D	T	FERSA		PG.
45,242	73,431	19,558	LM 102949/ LM 102910	TRBI	28
45,242	77,788	19,842	LM 603049/ LM 603011	TRBI	29
45,242	77,788	21,430	LM 603049/ LM 603012	TRBI	29
45,242	79,975	19,842	LM 603049/ LM 603014	TRBI	29
45,300	80,000	48,000	F 15174	TRBDR	54
45,618	82,931	23,812	25590/25520	TRBI	23
45,618	82,931	23,812	F 15383	TRBS	40
45,618	82,931	26,988	25590/25523	TRBI	23
45,618	83,058	23,812	25590/25521	TRBI	23
45,618	83,058	23,876	25590/25522	TRBI	23
45,987	74,976	18,000	LM 503349 A/ LM 503310	TRBI	29
45,987	74,976	18,000	LM 503349/ LM 503310	TRBI	29
46,030	73,660	15,875	F 18012	BBC	106
46,030	73,660	18,000	F 18013	BBC	106
46,038	79,375	17,462	18690/18620	TRBI	22
46,038	85,000	20,638	359 A/354 X	TRBI	14
46,038	85,000	20,638	359 S/354 X	TRBI	14
46,279	82,956	23,812	T 182	TRBT	60
47,000	53,000	25,000	F 17111 K	NRBS	132
47,000	81,000	53,000	F 16199	BBDRACS	92
47,000	88,000	55,000	F 15268	TRBDR	54
47,625	88,900	20,638	369 A/362 A	TRBI	14
47,625	88,900	20,638	369 S/362 A	TRBI	14
47,625	88,900	25,400	M 804048/ M 804010	TRBI	30
47,625	88,900	25,400	M 804049/ M 804010	TRBI	30
47,625	90,000	20,000	369 A/363	TRBI	14
47,625	90,000	20,000	369 S/362	TRBI	14
47,625	90,000	20,000	369 S/363	TRBI	14
47,625	93,264	30,162	3778/3720	TRBI	18
47,625	95,250	30,162	HM 804846/ HM 804810	TRBI	30
47,625	96,838	21,000	386 A/382 A	TRBI	14
47,625	101,600	34,925	528/522	TRBI	15
47,625	107,950	36,512	536/532 X	TRBI	16
47,625	111,125	30,162	55187 C/55437	TRBI	26
47,625	123,825	36,512	72187/72487	TRBI	27
47,625	123,825	36,512	72187 C/72487	TRBI	27
47,879	82,956	23,812	T 188	TRBT	60
49,000	84,000	48,000	F 15068	TRBDR	52
49,000	84,000	48,000	F 15168	TRBDR	54

14.2\ Fersa dimensional list

Lista dimensional Fersa

d	D	T	FERSA		PG.
49,000	88,000	46,000	F 16109	BBDRACS	90
49,000	88,000	48,000	F 16208	BBDRACS	94
49,212	103,188	43,658	5395/5335	TRBI	19
49,212	104,775	36,512	HM 807044/ HM 807010	TRBI	30
49,930	80,000	15,000	F 19030	CRBS	120
49,987	89,980	24,750	28579/28520	TRBI	23
50,000	-	41,000	CONE F 15244	CONE	48
50,000	-	41,275	CONE F 15113	CONE	48
50,000	55,000	20,000	F 17045 K	NRBS	128
50,000	56,010	43,700	F 17079 K	NRBS	130
50,000	78,000	22,000	T 1004	TRBT	60
50,000	80,000	16,000	6010	BB	65
50,000	80,000	20,000	32010 XF	TRBM	10
50,000	80,000	20,000	32010 XR	TRBM	10
50,000	80,000	23,000	63010	BB	73
50,000	80,000	24,000	33010 F	TRBM	12
50,000	82,000	21,500	JLM 104945/ JLM 104910	TRBI	28
50,000	82,000	21,500	JLM 104946/ JLM 104910	TRBI	28
50,000	82,000	21,500	JLM 104948/ JLM 104910	TRBI	28
50,000	82,550	21,500	JLM 104948/ LM 104911	TRBI	28
50,000	83,000	20,500	F 15201	TRBS	36
50,000	84,000	22,000	JLM 704649/ JLM 704610	TRBI	29
50,000	85,000	26,000	33110 F	TRBM	12
50,000	90,000	8,750	30210 BF	TRBF	42
50,000	90,000	20,000	6210	BB	68
50,000	90,000	20,000	365/362	TRBI	14
50,000	90,000	20,000	F 18032	BBS	76
50,000	90,000	20,000	F 18033	BBS	76
50,000	90,000	20,000	F 18041	BBS	76
50,000	90,000	20,000	NJ 210 FM/C3	CRB	114
50,000	90,000	21,750	30210 F	TRBM	8
50,000	90,000	23,000	F 19026	CRBS	118
50,000	90,000	24,750	32210 F	TRBM	10
50,000	90,000	28,000	JM 205149/ JM 205110	TRBI	28
50,000	90,000	30,200	3210 B 2RS/C3	BBDRAC	96
50,000	90,000	32,000	33210 F	TRBM	13
50,000	90,000	40,000	F 16202	BBDRACS	94
50,000	90,000	62,800	GE 50 KRRB	IB	110
50,000	90,000	16,000 / 22,000	F 18049	BBS	78
50,000	93,264	30,162	F 15054/3720	TRBS	32

d	D	T	FERSA		PG.
50,000	100,000	25,000	F 19046	CRBS	120
50,000	100,000	36,000	JF 5049/JF 5010	TRBI	19
50,000	105,000	32,000	JW 5049/JW 5010	TRBI	19
50,000	105,000	37,000	JHM 807045/ JHM 807012	TRBI	30
50,000	110,000	27,000	6310	BB	72
50,000	110,000	27,000	NJ 310 FM	CRB	114
50,000	110,000	27,000	NU 310 FM	CRB	115
50,000	110,000	27,000	NU 310 FM/C3	CRB	115
50,000	110,000	27,000	NU 310 FMN/C3	CRB	115
50,000	110,000	27,000	NUP 310 FM/C3	CRB	115
50,000	110,000	27,000	NUP 310 FNR/ C3	CRB	115
50,000	110,000	27,000	NUP 310 FP	CRB	115
50,000	110,000	29,250	30310 F	TRBM	9
50,000	110,000	29,250	31310 F	TRBM	9
50,000	110,000	42,250	32310 F	TRBM	11
50,000	110,000	32,300 / 27,000	F 19070	CRBS	122
50,000	110,000	32,300 / 27,000	F 19071	CRBS	122
50,000	130,000	31,000	6410	BB	74
50,800	60,325	25,400	F 17060 K	NRBS	130
50,800	82,000	21,976	LM 104949/ JLM 104910	TRBI	28
50,800	82,550	21,590	LM 104949/ LM 104911	TRBI	28
50,800	82,931	21,590	LM 104949/ LM 104912	TRBI	28
50,800	85,000	17,462	18790/18720	TRBI	22
50,800	88,900	20,638	368 A/362 A	TRBI	14
50,800	89,980	24,750	28580/28520	TRBI	23
50,800	90,000	25,000	368 A/362 X	TRBI	14
50,800	92,075	24,608	28580/28521	TRBI	23
50,800	93,264	30,162	3775/3720	TRBI	18
50,800	93,264	30,162	3780/3720	TRBI	18
50,800	93,264	30,162	3784/3720	TRBI	18
50,800	93,662	30,162	3780/3727	TRBI	18
50,800	93,662	30,162	3784/3727	TRBI	18
50,800	95,250	27,783	33889/33821	TRBI	24
50,800	95,250	27,783	33889/33822	TRBI	24
50,800	96,838	21,000	385 A/382 A	TRBI	14
50,800	98,425	21,000	385 A/382	TRBI	14
50,800	99,995	24,607	28580/ 28527 RB	TRBI	23
50,800	100,000	34,925	529/520 X1	TRBI	15
50,800	100,000	35,000	F 15047	TRBS	32

d	D	T	FERSA		PG.
50,800	101,600	31,750	49585/49520	TRBI	26
50,800	101,600	34,925	529 X/522	TRBI	16
50,800	101,600	34,925	529/522	TRBI	16
50,800	104,775	12,000	F 15212	TRBF	42
50,800	104,775	12,000	HM 807046/ HM 807010 BT	TRBF	42
50,800	104,775	30,162	45284/45220	TRBI	25
50,800	104,775	30,162	45285 A/45220	TRBI	25
50,800	104,775	30,162	45285 A/45221	TRBI	25
50,800	104,775	30,162	455/453 X	TRBI	15
50,800	104,775	36,512	HM 807046/ HM 807010	TRBI	30
50,800	104,775	39,687	4580/4535	TRBI	19
50,800	107,950	36,512	537/532 X	TRBI	16
50,800	109,538	22,225	T 200	TRBT	60
50,800	109,538	22,225	T 200 A	TRBT	60
50,800	110,230	11,907	45285 A/ 45220 B	TRBF	42
50,800	111,125	30,162	55200 C/55437	TRBI	26
50,800	120,650	41,275	619/612	TRBI	16
50,800	123,825	36,512	72200 C/72487	TRBI	27
51,000	91,000	44,000	F 16076	BBDRACS	88
51,054	74,612	15,875	T 199	TRBT	60
51,592	88,900	20,638	368 S/362 A	TRBI	14
51,592	90,000	20,000	368 S/362	TRBI	14
52,000	-	24,000	CONE F 15333	CONE	48
52,388	92,075	24,608	28584/28521	TRBI	24
52,388	93,264	30,162	3767/3720	TRBI	18
52,388	95,250	27,783	33891/33821	TRBI	24
52,388	111,125	30,162	55206 C/55437	TRBI	26
52,400	83,800 / 89,000	20,300	F 15057	BBT	104
52,400	86,000 / 91,000	20,550	F 15031	BBT	104
53,870	123,820	38,100	557 S/552 A	TRBI	16
53,975	88,900	19,050	LM 806649/ LM 806610	TRBI	30
53,975	95,200	34,400	F 15295	TRBS	38
53,975	95,250	27,783	33895/33821	TRBI	24
53,975	95,250	27,783	33895/33822	TRBI	24
53,975	96,838	21,000	389 A/382 A	TRBI	14
53,975	98,425	21,000	389 A5/382	TRBI	15
53,975	100,000	21,000	389 A/383 A	TRBI	15
53,975	104,775	36,512	HM 807049/ HM 807010	TRBI	30
53,975	107,950	36,512	539/532 X	TRBI	16
53,975	111,125	30,162	55212 C/55437	TRBI	26
53,975	111,125	38,100	539/532 A	TRBI	16

d	D	T	FERSA		PG.
53,975	120,650	41,275	621/612	TRBI	16
53,975	123,825	36,512	72212 C/72487	TRBI	27
53,975	123,825	36,512	72212/72487	TRBI	27
53,975	127,000	50,800	6280/6220	TRBI	19
53,975	140,030	36,513	78215 C/78551	TRBI	27
53,980	82,000	14,650	F 15376	TRBS	40
54,000	142,000	62,000	F 15146	TRBDR	52
54,000	158,000	51,000	F 15324	TRBDR	54
54,487	104,775	36,512	HM 807048/ HM 807010	TRBI	30
54,988	111,125	38,100	538/532	TRBI	16
55,000	-	29,800	CONE F 15111	CONE	48
55,000	-	29,800	CONE F 15269	CONE	48
55,000	60,000	20,000	F 17046 K	NRBS	128
55,000	60,000	30,000	F 17109 K	NRBS	132
55,000	63,000	20,000	F 17112 K	NRBS	132
55,000	80,000	17,000	32911 F	TRBM	12
55,000	90,000	18,000	6011	BB	66
55,000	90,000	18,000	NU 1011 FM	CRB	115
55,000	90,000	23,000	32011 XF	TRBM	10
55,000	90,000	23,000	JLM 506849/ JLM 506810	TRBI	29
55,000	90,000	25,000	JLM 506849 A/ JLM 506811	TRBI	29
55,000	90,000	27,000	33011 F	TRBM	12
55,000	90,000	55,000	F 15302	TRBDR	54
55,000	90,000	60,000	F 15121	WH	136
55,000	91,500	25,000	F 15141	BBC	106
55,000	95,000	29,000	JM 207049 A/ JM 207010	TRBI	28
55,000	95,000	29,000	JM 207049/ JM 207010	TRBI	28
55,000	95,000	30,000	33111 F	TRBM	12
55,000	95,000	30,000	F 15323	TRBS	38
55,000	96,838	21,000	385/382 A	TRBI	14
55,000	98,425	21,000	385/382	TRBI	14
55,000	100,000	21,000	6211	BB	68
55,000	100,000	21,000	F 19101	CRBS	122
55,000	100,000	21,000	N 211 FMNR/C4	CRB	114
55,000	100,000	21,000	NUP 211 FM/C3	CRB	115
55,000	100,000	21,000	QJ 211 FM	BB4PAC	98
55,000	100,000	21,000	QJ 211 FM/C3	BB4PAC	98
55,000	100,000	21,000	F 19108	CRBS	124
55,000	100,000	22,750	30211 F	TRBM	8
55,000	100,000	26,750	32211 F	TRBM	10
55,000	100,000	35,000	33211 F	TRBM	13
55,000	104,000	27,000	F 19097	CRBS	122

14.2\ Fersa dimensional list

Lista dimensional Fersa

d	D	T	FERSA		PG.
55,000	110,000	42,250	32310/55	TRBM	11
55,000	115,000	34,000	JW 5549/JW 5510	TRBI	19
55,000	116,000	28,000	F 18054	BBS	78
55,000	117,000	38,000	F 15332	TRBS	38
55,000	120,000	29,000	6311	BB	72
55,000	120,000	29,000	F 18042	BBS	76
55,000	120,000	29,000	F 18056	BBS	78
55,000	120,000	29,000	NUP 311 FMNR/ C3	CRB	116
55,000	120,000	31,500	30311 F	TRBM	9
55,000	120,000	31,500	31311 F	TRBM	9
55,000	120,000	45,500	32311 F	TRBM	11
55,000	140,000	33,000	6411	BB	74
55,000	140,000	45,000	F 15256	TRBS	36
55,560	97,630	24,600	28680/28622	TRBI	24
55,562	122,238	43,658	5566/5535	TRBI	19
55,562	123,825	36,512	72218 C/72487	TRBI	27
55,562	127,000	36,512	HM 813840/ HM 813811	TRBI	30
57,000	63,000	37,000	F 17103 K	NRBS	132
57,150	96,838	21,000	387 A/382 A	TRBI	14
57,150	96,838	21,000	387 A5/382 A	TRBI	14
57,150	96,838	21,000	387/382 A	TRBI	14
57,150	96,838	24,608	28682/28621	TRBI	24
57,150	96,838	25,400	387 A/382 S	TRBI	14
57,150	96,838	25,400	387 A5/382 S	TRBI	14
57,150	96,838	25,400	387 S/382 S	TRBI	14
57,150	96,838	25,400	387/382 S	TRBI	14
57,150	97,630	24,608	28682/28622	TRBI	24
57,150	98,425	21,000	387 A/382	TRBI	14
57,150	98,425	21,000	387 S/382	TRBI	14
57,150	98,425	21,000	387/382	TRBI	14
57,150	100,000	21,000	387 A/383 A	TRBI	14
57,150	100,000	21,000	387 S/383 A	TRBI	14
57,150	104,775	30,162	45289/45220	TRBI	25
57,150	104,775	30,162	45291/45220	TRBI	25
57,150	104,775	30,162	462 A/453 X	TRBI	15
57,150	104,775	30,162	462/453 X	TRBI	15
57,150	104,775	30,162	469/453 X	TRBI	15
57,150	110,000	22,000	390/394 A	TRBI	15
57,150	110,000	29,147	3979/ JM 511910	TRBI	18
57,150	112,712	30,162	39580/39520	TRBI	25
57,150	112,712	30,162	39581/39520	TRBI	25
57,150	119,985	32,750	39580/39528	TRBI	25
57,150	123,825	36,512	72225 C/72487	TRBI	27

d	D	T	FERSA		PG.
57,150	123,825	38,100	555 S/552 A	TRBI	16
57,150	140,030	36,513	78225 C/78551	TRBI	27
57,165	140,000	28,250	F 15133	TRBS	34
57,531	98,425	21,000	388 A/382	TRBI	14
57,800 / 58,000	110,000	115,000	F 200015	WK	138
59,972	122,238	33,338	66589/66520	TRBI	26
59,987	130,175	34,100	HM 911244/ HM 911210	TRBI	31
59,987	134,983	33,449	HM 911244/ HM 911216	TRBI	31
60,000	68,000	23,000	F 17108 K	NRBS	132
60,000	68,000	25,000	F 17107 K	NRBS	132
60,000	68,000	32,000	F 17056 K	NRBS	128
60,000	68,000	39,000	F 17061 K	NRBS	130
60,000	68,000	40,000	F 17090 K	NRBS	130
60,000	68,000	41,700	F 17059 K	NRBS	130
60,000	89,000	15,200	F 15377	TRBS	40
60,000	95,000	18,000	6012	BB	66
60,000	95,000	23,000	32012 XF	TRBM	10
60,000	95,000	24,000	JLM 508748/ JLM 508710	TRBI	29
60,000	95,000	26,500	F 15329	TRBS	38
60,000	95,000	27,000	F 15088	TRBS	34
60,000	96,500	25,600	F 15140	BBC	106
60,000	96,500	29,600	F 15139	BBC	106
60,000	96,600	30,800	F 15357	BBC	106
60,000	100,000	30,000	33112 F	TRBM	12
60,000	100,000	30,000	F 15258	TRBS	36
60,000	108,000	75,000	F 15120	WH	136
60,000	110,000	22,000	6212	BB	69
60,000	110,000	22,000	F 19011	CRBS	118
60,000	110,000	22,000	F 19088	CRBS	122
60,000	110,000	22,000	NUP 212 FM	CRB	115
60,000	110,000	22,000	QJ 212 FM	BB4PAC	98
60,000	110,000	22,000	QJ 212 FM/C3	BB4PAC	98
60,000	110,000	23,750	30212 F	TRBM	8
60,000	110,000	28,000	62212	BB	70
60,000	110,000	28,000	F 19042	CRBS	120
60,000	110,000	28,000	NUP 2212 FM/ C3	CRB	116
60,000	110,000	28,000	NUP 2212 FMNR/C3	CRB	116
60,000	110,000	28,000	NUP 2212 FP/ C3	CRB	116
60,000	110,000	29,750	32212 F	TRBM	10
60,000	110,000	29,750	F 15347	TRBS	40
60,000	110,000	34,000	F 15334	TRBS	38

d	D	T	FERSA		PG.
60,000	110,000	36,500	3212 B 2RS/C3	BBDRAC	96
60,000	110,000	38,000	33212 F	TRBM	13
60,000	110,000	38,000	F 15348	TRBS	40
60,000	112,000	33,000	F 15005	BBC	106
60,000	115,000	39,000	F 15273	TRBS	38
60,000	115,000	40,000	F 15346	TRBS	40
60,000	115,000	40,000	JF 6049/ JF 6010	TRBI	19
60,000	116,000	28,000	F 19047	CRBS	120
60,000	120,000	29,795	476/472	TRBI	15
60,000	125,000	37,000	F 15270	TRBS	36
60,000	125,000	37,000	JW 6049/ JW 6010	TRBI	19
60,000	125,000	37,000	F 15386	TRBS	40
60,000	130,000	12,250	F 15192	TRBF	42
60,000	130,000	31,000	6312	BB	72
60,000	130,000	31,000	F 18055	BBS	78
60,000	130,000	31,000	F 19009	CRBS	118
60,000	130,000	31,000	NUP 312 FMNR/ C3	CRB	116
60,000	130,000	33,500	30312 F	TRBM	9
60,000	130,000	33,500	31312 F	TRBM	9
60,000	130,000	33,800	F 15245	TRBS	36
60,000	130,000	35,250	F 15298	TRBS	38
60,000	130,000	39,000	F 15046	TRBS	32
60,000	130,000	48,500	32312 BF	TRBM	11
60,000	130,000	48,500	32312 F	TRBM	11
60,000	135,000	37,000	F 15158	TRBS	34
60,000	150,000	35,000	6412	BB	74
60,000	150,000	51,000	F 15255	TRBS	36
60,000	168,000	100,000	F 300010	WM	142
60,000	168,000	102,000	F 300007	WM	142
60,325	100,000	25,400	28985/28921	TRBI	24
60,325	101,600	25,400	28985/28920	TRBI	24
60,325	112,712	30,162	3980/3920	TRBI	18
60,325	122,238	38,100	HM 212044/ HM 212011	TRBI	28
60,325	127,000	16,670	65237/65500 B	TRBF	42
60,325	127,000	36,512	HM 813841/ HM 813810	TRBI	30
60,325	127,000	36,512	HM 813841/ HM 813811	TRBI	30
60,325	127,000	44,450	65237/65500	TRBI	26
60,325	130,175	36,512	HM 911245/ HM 911210	TRBI	31
60,325	136,525	46,038	H 715332/ H 715311	TRBI	29
61,912	110,000	22,000	392/394 A	TRBI	15

d	D	T	FERSA		PG.
61,912	127,000	36,512	HM 813843/ HM 813810	TRBI	30
61,912	136,525	46,038	H 715334/ H 715311	TRBI	29
61,912	146,050	41,275	H 913842/ H 913810	TRBI	31
61,912	146,050	41,275	H 913843/ H 913810	TRBI	31
62,000	70,000	37,000	F 17052 K	NRBS	128
62,000	70,000	40,000	F 17099 K	NRBS	130
62,000	147,000	50,000	F 15184	TRBS	34
62,000	260,000	107,000	F 15321	PM	38
63,000	-	34,800	F 19016	CRBS	118
63,000	-	37,500	F 19038	CRBS	120
63,000	71,000	50,800	F 17089 K	NRBS	130
63,485	94,975	17,000	L 910349/ L 910310	TRBI	31
63,500	100,000	23,000	F 18040	BBC	106
63,500	102,000	20,570	F 18031	BBC	106
63,500	103,000	21,400	F 15118	BBC	106
63,500	104,775	21,433	39250/39412	TRBI	25
63,500	107,950	25,400	29585/29520	TRBI	24
63,500	107,950	25,400	29586/29520	TRBI	24
63,500	107,950	25,400	29586/29522	TRBI	24
63,500	107,950	25,400	F 15304	TRBS	38
63,500	110,000	22,000	395/394 A	TRBI	15
63,500	110,000	30,162	3982/3927 X	TRBI	18
63,500	112,712	30,162	39585/39520	TRBI	25
63,500	112,712	30,162	3982/3920	TRBI	18
63,500	122,238	38,100	HM 212047/ HM 212011	TRBI	28
63,500	123,825	38,100	559/552 A	TRBI	16
63,500	127,000	36,512	HM 813842/ HM 813810	TRBI	30
63,500	136,525	46,038	H 715336/ H 715311	TRBI	29
63,500	99,900 / 105,000	23,000	F 15058	BBT	104
65,000	-	31,000	CONE F 15134	CONE	48
65,000	70,000	20,000	F 17043 K	NRBS	128
65,000	70,000	30,000	F 17113 K	NRBS	132
65,000	73,000	33,000	F 17102 K	NRBS	132
65,000	96,500	22,500	F 15209	BBC	106
65,000	100,000	18,000	6013	BB	66
65,000	100,000	23,000	32013 XF	TRBM	10
65,000	100,000	27,000	33013 F	TRBM	12
65,000	101,700	21,750	F 15211	BBC	106
65,000	105,000	24,000	JLM 710949 C/ JLM 710910	TRBI	29

14.2\ Fersa dimensional list

Lista dimensional Fersa

d	D	T	FERSA		PG.
65,000	110,000	13,000	33113 B	TRBF	42
65,000	110,000	28,000	JM 511945/ JM 511910	TRBI	29
65,000	110,000	28,000	JM 511946/ JM 511910	TRBI	29
65,000	110,000	31,000	JD 6549/ JD 6510	TRBI	19
65,000	110,000	34,000	33113 F	TRBM	12
65,000	112,712	29,020	JM 511945/ 3920	TRBI	29
65,000	120,000	23,000	6213	BB	69
65,000	120,000	23,000	NUP 213 FPNR/ C3	CRB	115
65,000	120,000	24,750	30213 F	TRBM	8
65,000	120,000	32,750	32213 F	TRBM	11
65,000	120,000	32,750	F 15322	TRBS	38
65,000	120,000	39,000	JH 211749/ JH 211710	TRBI	28
65,000	120,000	41,000	33213 F	TRBM	13
65,000	140,000	33,000	6313	BB	72
65,000	140,000	33,000	F 19064	CRBS	120
65,000	140,000	33,350	F 19010	CRBS	118
65,000	140,000	36,000	30313 F	TRBM	9
65,000	140,000	36,000	31313 F	TRBM	9
65,000	140,000	51,000	32313 BF	TRBM	11
65,000	140,000	51,000	32313 F	TRBM	11
65,000	145,000	36,000	F 15082	TRBS	34
65,000	145,000	39,500	F 15083	TRBS	34
65,000	147,100	13,500	F 15265	TRBF	42
65,000	150,000	38,000	F 15119	TRBS	34
65,000	152,000	48,000	F 15253	TRBS	36
65,000	160,000	37,000	6413	BB	74
65,000	160,000	37,000	F 19105	CRBS	124
65,000	160,000	37,000	F 19106	CRBS	124
65,000	165,000	36,000	F 15183	TRBS	34
65,000	165,000	40,000	F 15159	TRBS	34
65,000	111,700 / 113,600	22,100	F 15060	BBT	104
65,088	135,755	53,975	6379/6320	TRBI	19
65,088	136,525	46,038	H 715340/ H 715311	TRBI	29
65,987	123,975	41,500	H 212749/ H 212710	TRBI	28
66,675	107,950	25,400	29590/29520	TRBI	24
66,675	107,950	25,400	29590/29522	TRBI	24
66,675	110,000	22,000	395 A/394 A	TRBI	15
66,675	110,000	22,000	395 S/394 A	TRBI	15
66,675	110,000	30,162	3994/3927 X	TRBI	18

d	D	T	FERSA		PG.
66,675	112,712	30,162	39590/39520	TRBI	25
66,675	112,712	30,162	3984/3920	TRBI	18
66,675	112,712	30,162	3984/3925	TRBI	18
66,675	112,712	30,162	3994/3920	TRBI	18
66,675	117,475	30,162	33262/33462	TRBI	24
66,675	117,475	30,162	33262 A/33461	TRBI	24
66,675	122,238	38,100	HM 212049/ HM 212010	TRBI	28
66,675	122,238	38,100	HM 212049/ HM 212011	TRBI	28
66,675	127,000	36,512	HM 813844/ HM 813810	TRBI	30
66,675	130,175	41,275	641/633	TRBI	16
66,675	135,755	53,975	6386/6320	TRBI	19
66,675	136,525	41,275	641/632	TRBI	16
66,675	136,525	41,275	H 414242/ H 414210	TRBI	28
66,675	136,525	46,038	H 715341/ H 715311	TRBI	29
67,000	-	32,000	F 19061	CRBS	120
67,000	-	38,000	F 19062	CRBS	120
67,000	75,000	37,000	F 17057 K	NRBS	130
67,000	75,000	44,000	F 17058 K	NRBS	130
68,000	140,000	49,450	F 15366	TRBS	40
68,000 / 68,200	125,000	115,000	F 200013	WK	138
68,000 / 68,200	127,000 / 132,000	115,000	F 15097	WH	136
68,000	272,000	100,500	F 15371	PM	40
68,260	-	44,250	CONE F 15327	CONE	48
68,262	110,000	22,000	399 A/394 A	TRBI	15
68,262	110,000	22,000	399 AS/394 A	TRBI	15
68,262	136,525	41,275	H 414245 X/ H 414210	TRBI	29
68,262	136,525	46,038	H 715343/ H 715311	TRBI	29
68,262	152,400	47,625	F 15367	TRBS	40
68,262	161,925	49,212	9278/9220	TRBI	19
69,800 / 70,000	125,000	114,000	F 200016	WK	138
69,800 / 70,000	119,700 / 124,700	110,500	F 200019	WK	140
69,840	112,200 / 113,800	22,100	F 15059	BBT	104
69,850	-	51,750	CONE F 15328	CONE	48
69,850	101,600	19,050	L 713049/ L 713010	TRBI	29
69,850	112,712	25,400	29675/29620	TRBI	24
69,850	116,980	71,880	F 15380	TRBDR	40

d	D	T	FERSA		PG.
69,850	117,475	30,162	33275/33462	TRBI	24
69,850	120,000	29,002	482/472 A	TRBI	15
69,850	120,000	29,794	33275/33472	TRBI	24
69,850	120,000	29,795	482/472	TRBI	15
69,850	120,000	32,545	47487/47420	TRBI	25
69,850	120,000	46,751	482 E/472	TRBI	15
69,850	120,650	25,400	29675/29630	TRBI	24
69,850	123,825	30,162	482/472 X	TRBI	15
69,850	126,000	63,880	F 15330	TRBDR	38
69,850	127,000	36,512	566/563	TRBI	16
69,850	146,050	41,275	H 913849/ H 913810	TRBI	31
70,000	76,000	20,000	F 17044 K	NRBS	128
70,000	78,000	37,000	F 17053 K	NRBS	128
70,000	78,000	43,000	F 17101 K	NRBS	132
70,000	110,000	13,000	16014	BB	75
70,000	110,000	20,000	6014	BB	66
70,000	110,000	25,000	32014 XF	TRBM	10
70,000	110,000	26,000	JLM 813049/ JLM 813010	TRBI	30
70,000	110,000	31,000	33014 F	TRBM	12
70,000	115,000	29,000	JM 612949/ JM 612910	TRBI	29
70,000	120,000	29,002	484/472 A	TRBI	15
70,000	120,000	29,795	484/472	TRBI	15
70,000	120,000	37,000	33114 F	TRBM	12
70,000	125,000	24,000	6214	BB	69
70,000	125,000	26,250	30214 F	TRBM	8
70,000	125,000	33,250	32214 F	TRBM	11
70,000	125,000	41,000	33214 F	TRBM	13
70,000	130,000	43,000	JF 7049 A/ JF 7010	TRBI	19
70,000	130,000	43,000	JF 7049/JF 7010	TRBI	19
70,000	130,000	57,000	F 15051 C	TRBS	32
70,000	130,000	57,000	F 15051 R	TRBS	32
70,000	140,000	26,000	F 18053	BBS	78
70,000	140,000	39,000	JW 7049/ JW 7010	TRBI	19
70,000	150,000	35,000	6314	BB	73
70,000	150,000	35,000	NUP 314 FM/C3	CRB	116
70,000	150,000	35,000	NUP 314 FMNR/ C3	CRB	116
70,000	150,000	38,000	30314 F	TRBM	9
70,000	150,000	38,000	31314 F	TRBM	9
70,000	150,000	39,800	F 15116	TRBS	34
70,000	150,000	41,275	F 15114	TRBS	34
70,000	150,000	54,000	32314 BF	TRBM	11

d	D	T	FERSA		PG.
70,000	150,000	54,000	32314 F	TRBM	11
70,000	150,000	64,000	F 15193	TRBS	36
70,000	150,000	74,000	F 15271	TRBS	36
70,000	165,000	57,000	F 15254	TRBS	36
70,000	165,000	57,000	F 15361	TRBS	40
70,000	180,000	42,000	6414	BB	75
70,000	195,000	110,000	F 300003	WM	142
70,000	196,000	140,000	F 300005	WM	142
71,438	117,475	30,162	33281/33462	TRBI	24
71,438	120,000	29,794	33281/33472	TRBI	24
71,438	120,000	32,545	47490/47420	TRBI	25
71,438	127,000	36,512	HM 813849/ HM 813810	TRBI	31
71,438	127,000	36,512	HM 813849/ HM 813811	TRBI	31
71,438	136,525	41,275	644/632	TRBI	16
71,438	136,525	46,038	H 715345/ H 715311	TRBI	30
71,438	136,525	49,213	H 715345/ H 715313 W	TRBI	30
72,000	80,000	29,800	F 17077 K	NRBS	130
72,000	80,000	40,000	F 17076 K	NRBS	130
72,000	130,000	25,000	F 18060	BBS	78
73,000	79,000	50,000	F 17110 K	NRBS	132
73,025	112,712	25,400	29685/29620	TRBI	24
73,025	117,475	30,162	33287/33462	TRBI	24
73,025	120,000	29,794	33287/33472	TRBI	24
73,025	127,000	36,512	567 X/563	TRBI	16
73,025	127,000	36,512	567/563	TRBI	16
73,025	139,992	36,512	576/572	TRBI	16
73,817	112,712	25,400	29688/29620	TRBI	24
73,817	127,000	36,512	568/563	TRBI	16
75,000	83,000	23,000	F 17063 K	NRBS	130
75,000	83,000	33,000	F 17104 K	NRBS	132
75,000	83,000	35,000	F 17062 K	NRBS	130
75,000	83,000	40,000	F 17064 K	NRBS	130
75,000	83,000	48,000	F 17097 K	NRBS	130
75,000	83,000	55,000	F 17031 K	NRBS	128
75,000	105,000	16,000	61915	BB	66
75,000	115,000	20,000	6015	BB	66
75,000	115,000	25,000	32015 XF	TRBM	10
75,000	115,000	25,000	JLM 714149/ JLM 714110	TRBI	29
75,000	115,000	31,000	33015 F	TRBM	12
75,000	120,000	31,000	JM 714249/ JM 714210	TRBI	29
75,000	125,000	37,000	33115 F	TRBM	12

14.2\ Fersa dimensional list

Lista dimensional Fersa

d	D	T	FERSA		PG.
75,000	130,000	25,000	6215	BB	69
75,000	130,000	25,000	NJ 215 F/C3	CRB	114
75,000	130,000	25,000	NJ 215 FP/C3	CRB	114
75,000	130,000	27,250	30215 F	TRBM	8
75,000	130,000	31,000	NU 2215 FM	CRB	115
75,000	130,000	33,250	32215 F	TRBM	11
75,000	130,000	41,000	33215 F	TRBM	13
75,000	140,000	34,250	F 15190	TRBS	34
75,000	160,000	37,000	6315	BB	73
75,000	160,000	40,000	30315 F	TRBM	9
75,000	160,000	40,000	31315 F	TRBM	9
75,000	160,000	55,000	NJ 2315 FM/C4	CRB	114
75,000	160,000	58,000	32315 F	TRBM	11
75,000	160,000	58,000	F 15071	TRBS	32
75,000	180,000	63,500	F 15048	TRBS	32
75,000	190,000	45,000	6415	BB	75
75,987	131,975	39,000	HM 215249/ HM 215210	TRBI	28
76,200	109,538	19,050	L 814749/ L 814710	TRBI	31
76,200	121,442	11,907	34300/34478 B	TRBF	42
76,200	121,442	24,608	34300/34478	TRBI	25
76,200	127,000	26,988	34300/34500	TRBI	25
76,200	127,000	26,988	34301/34500	TRBI	25
76,200	127,000	30,162	42688/42620	TRBI	25
76,200	133,350	30,162	495 A/492 A	TRBI	15
76,200	133,350	33,338	47679/47620	TRBI	26
76,200	135,733	44,450	5760/5735	TRBI	19
76,200	136,525	30,162	495 A/493	TRBI	15
76,200	139,700	36,512	575/572 X	TRBI	16
76,200	139,982	35,250	575/572 A	TRBI	16
76,200	139,992	36,512	575/572	TRBI	16
76,200	146,050	41,275	659/653	TRBI	16
76,200	149,220	53,975	6461 A/6420	TRBI	19
76,200	149,225	53,975	6461/6420	TRBI	19
76,200	161,925	49,212	9285/9220	TRBI	19
76,200	171,450	49,212	F 15291	TRBS	38
76,200	171,450	49,212	9380/9321	TRBI	19
77,000	101,000	29,200	F 19087	CRBS	122
77,788	117,475	25,400	LM 814849/ LM 814810	TRBI	31
77,788	121,442	24,608	34306/34478	TRBI	25
78,000	86,000	35,000	F 17032 K	NRBS	128
78,000	110,000	8,700	F 15224	BBC	106
78,000	130,000	90,000	F 15125	WH	136
78,000	130,000	90,500	F 15127	WH	136

d	D	T	FERSA		PG.
80,000	88,000	35,000	F 17100 K	NRBS	132
80,000	110,000	16,000	F 18052	BBS	78
80,000	125,000	22,000	6016	BB	66
80,000	125,000	29,000	32016 XF	TRBM	10
80,000	125,000	36,000	33016 F	TRBM	12
80,000	130,000	5,500	F 15246	TRBF	42
80,000	130,000	35,000	JM 515649/ JM 515610	TRBI	29
80,000	130,000	37,000	33116 F	TRBM	12
80,000	139,992	14,288	F 15191	TRBF	42
80,000	140,000	26,000	6216	BB	69
80,000	140,000	26,000	F 18059	BBS	78
80,000	140,000	28,250	30216 F	TRBM	8
80,000	140,000	33,000	NU 2216 FM	CRB	115
80,000	140,000	33,500	F 19039	CRBS	120
80,000	140,000	35,250	32216 F	TRBM	11
80,000	140,000	39,250	F 15156	TRBS	34
80,000	140,000	46,000	33216 F	TRBM	13
80,000	140,000	46,000	33216 F 573810	TRBM	13
80,000	150,000	28,000	6217/80	BB	69
80,000	150,000	27,500 / 28,000	F 19008	CRBS	118
80,000	160,000	45,000	JW 8049/ JW 8010	TRBI	19
80,000	165,000	57,000	F 15257	TRBS	36
80,000	170,000	42,500	30316 F	TRBM	9
80,000	170,000	42,500	31316 F	TRBM	9
80,000	170,000	61,500	32316 F	TRBM	11
80,000	200,000	48,000	NJ 416 FM/C3	CRB	114
80,962	136,525	30,162	496/493	TRBI	15
80,962	150,089	44,450	740/742	TRBI	17
82,000	90,000	37,000	F 17051 K	NRBS	128
82,000	90,000	60,000	F 17098 K	NRBS	130
82,000	138,000	110,000	F 200029	WK	140
82,000	138,000	130,000	F 200018	WK	140
82,000	140,000	36,500	F 15252	TRBS	36
82,000	140,000	110,000	F 15126	WH	136
82,000	140,000	115,000	F 15100	WH	136
82,000	140,000	115,000	F 15300	WH	136
82,000	196,000	113,000	F 300001	WM	142
82,550	125,412	25,400	27687/27620	TRBI	23
82,550	133,350	30,162	495/492 A	TRBI	15
82,550	133,350	33,338	47686/47620	TRBI	26
82,550	133,350	39,687	HM 516449 A/ HM 516410	TRBI	29
82,550	133,350	39,688	HM 516449 C/ HM 516410	TRBI	29

d	D	T	FERSA		PG.
82,550	136,525	30,162	495/493	TRBI	15
82,550	136,525	39,687	HM 516448/ HM 516414 B	TRBI	29
82,550	136,525	44,453	47687/47623 A	TRBI	26
82,550	139,700	36,512	580/572 X	TRBI	16
82,550	139,982	35,250	580/572 A	TRBI	16
82,550	139,992	36,512	580/572	TRBI	16
82,550	139,992	36,513	582/572	TRBI	16
82,550	146,050	41,275	663/653	TRBI	17
82,550	150,089	44,450	749 A/742	TRBI	17
83,345	125,412	25,400	27690/27620	TRBI	23
84,000	90,000	39,500	F 17096 K	NRBS	130
84,138	133,350	30,162	498/492 A	TRBI	15
84,138	136,525	30,162	498/493	TRBI	15
84,970	125,410	25,400	27695/27620	TRBI	23
84,980	150,000	27,500 / 28,000	F 19022	CRBS	118
85,000	93,000	53,000	F 17035 K	NRBS	128
85,000	93,000	63,000	F 17091 K	NRBS	130
85,000	130,000	22,000	6017	BB	66
85,000	130,000	29,000	32017 XF	TRBM	10
85,000	130,000	30,000	JM 716649/ JM 716610	TRBI	30
85,000	130,000	36,000	33017 F	TRBM	12
85,000	140,000	39,000	JHM 516849/ JHM 516810	TRBI	29
85,000	140,000	41,000	33117 F	TRBM	12
85,000	150,000	28,000	6217	BB	69
85,000	150,000	28,000	F 18036	BBS	76
85,000	150,000	30,500	30217 F	TRBM	8
85,000	150,000	30,500	F 15104	TRBS	34
85,000	150,000	30,500	F 15345	TRBS	40
85,000	150,000	38,500	32217 F	TRBM	11
85,000	150,000	38,500	F 15326	TRBS	38
85,000	150,000	49,000	33217 F	TRBM	13
85,000	160,000	33,000	F 18037	BBS	76
85,000	180,000	63,500	32317 F	TRBM	11
85,026	150,089	44,450	749 S/742	TRBI	17
85,026	150,089	44,450	749/742	TRBI	17
85,725	146,050	41,275	665 A/653	TRBI	17
85,725	146,050	41,275	665/653	TRBI	17
85,725	133,350	30,162	497/492 A	TRBI	15
85,725	136,525	30,162	497/493	TRBI	15
86,000	94,000	45,000	F 17080 K	NRBS	130
88,000	138,000	120,000	F 200025	WK	140
88,000	140,000	32,000	F 15075	TRBS	34

d	D	T	FERSA		PG.
88,900	121,442	15,083	LL 217849/ LL 217810	TRBI	28
88,900	148,430	28,575	42350/42584	TRBI	25
88,900	152,400	39,688	HM 518445/ HM 518410	TRBI	29
88,900	161,925	47,625	759/752	TRBI	17
89,000	97,000	40,000	F 17034 K	NRBS	128
89,974	146,975	40,000	HM 218248/ HM 218210	TRBI	28
89,975	146,975	40,000	F 15115	TRBS	34
89,992	160,096	30,124	69354/69630	TRBI	27
90,000	98,000	40,500	F 17040 K	NRBS	128
90,000	98,000	46,000	F 17095 K	NRBS	130
90,000	130,000	14,000	16017/90	BB	75
90,000	140,000	24,000	F 18066	BBS	78
90,000	140,000	32,000	32018 XF	TRBM	10
90,000	140,000	39,000	33018 F	TRBM	12
90,000	145,000	35,000	JM 718149 A/ JM 718110	TRBI	30
90,000	145,000	35,000	JM 718149/ JM 718110	TRBI	30
90,000	150,000	45,000	33118 F	TRBM	12
90,000	155,000	44,000	JHM 318448/ JHM 318410	TRBI	28
90,000	160,000	30,000	6218	BB	69
90,000	160,000	32,500	30218 F	TRBM	8
90,000	160,000	42,500	32218 F	TRBM	11
90,000	160,000	125,000	F 15122	WH	136
90,000	190,000	46,500	31318 F	TRBM	9
92,000	100,000	27,000	F 17094 K	NRBS	130
92,000	100,000	53,000	F 17038 K	NRBS	128
92,075	146,050	33,338	47890/47820	TRBI	26
92,075	148,430	28,575	42362/42584	TRBI	25
92,075	150,000	35,992	598 A/593 X	TRBI	16
92,075	152,400	39,688	598 A/592 A	TRBI	16
92,075	152,400	39,688	598/592 A	TRBI	16
92,075	168,275	41,275	681 A/672	TRBI	17
92,075	168,275	41,275	681/672	TRBI	17
93,662	148,430	28,575	42368/42584	TRBI	25
93,800 / 94,000	148,000	135,000	F 200014	WK	138
95,000	103,000	60,000	F 17092 K	NRBS	130
95,000	126,000	18,100	F 15341	TRBS	40
95,000	135,000	20,000	JL 819349/ JL 819310	TRBI	31
95,000	145,000	32,000	32019 XF	TRBM	10
95,000	145,000	39,000	33019 F	TRBM	12

14.2\ Fersa dimensional list

Lista dimensional Fersa

d	D	T	FERSA		PG.
95,000	150,000	35,000	JM 719149/ JM 719113	TRBI	30
95,000	160,000	46,000	JF 9549/ JF 9510	TRBI	19
95,000	170,000	34,500	30219 F	TRBM	8
95,000	170,000	45,500	32219 F	TRBM	11
95,250	128,587	15,875	LL 319349/ LL 319310	TRBI	28
95,250	150,000	35,992	594 A/593 X	TRBI	16
95,250	150,000	35,992	594/593 X	TRBI	16
95,250	152,400	39,688	594 A/592 A	TRBI	16
95,250	152,400	39,688	594/592 A	TRBI	16
95,250	168,275	41,275	683/672	TRBI	17
95,250	171,450	47,625	77375/77675	TRBI	27
96,000	104,000	55,000	F 17039 K	NRBS	128
96,838	148,430	28,575	42381/42584	TRBI	25
99,800 / 100,000	148,000	135,000	F 200017	WK	140
99,975	156,975	42,000	F 15208	TRBS	36
99,975	156,975	42,000	HM 220149/ HM 220110	TRBI	28
100,000	145,000	24,000	JP 10049/ JP 10010	TRBI	20
100,000	145,000	24,000	JP 10049/ JP 10010 A	TRBI	20
100,000	148,000	141,000	F 200031	WK	140
100,000	150,000	32,000	32020 XF	TRBM	10
100,000	150,000	39,000	33020 F	TRBM	12
100,000	150,000	39,000	33020 F 561694	TRBM	12
100,000	155,000	36,000	JM 720249/ JM 720210	TRBI	30
100,000	160,000	41,000	JHM 720249/ JHM 720210	TRBI	30
100,000	160,000	42,000	F 15200	TRBS	36
100,000	160,000	44,000	F 15267	TRBS	36
100,000	165,000	47,000	JF 10049/ JF 10010	TRBI	20
100,000	180,000	37,000	30220 F	TRBM	8
100,000	180,000	49,000	32220 F	TRBM	11
100,000	180,000	49,000	32220 FR	TRBM	11
100,000	180,000	63,000	33220 F	TRBM	13
101,600	157,162	36,512	52400/52618	TRBI	26
101,600	160,000	35,000	F 15279	TRBS	38
101,600	168,275	41,275	687/672	TRBI	17
101,600	214,312	55,562	H 924033/ H 924010	TRBI	31
105,000	160,000	35,000	32021 XF	TRBM	10
105,000	160,000	43,000	33021 F	TRBM	12
105,000	160,000	43,000	33021 F 0266488	TRBM	12

d	D	T	FERSA		PG.
105,000	160,000	43,000	F 15239	TRBS	36
105,000	160,000	140,000	F 200004	WK	138
105,000	160,000	140,000	F 200032	WK	140
105,000	170,000	38,000	F 15076	TRBS	34
105,000	190,000	39,000	30221 F	TRBM	8
105,000	190,000	53,000	32221 F	TRBM	11
106,000	140,000	25,000	F 15210	BBC	106
106,000	160,000	35,000	F 15272	TRBS	38
107,950	158,750	23,020	37425/37625	TRBI	25
107,950	161,925	34,925	48190/48120	TRBI	26
107,950	165,100	36,512	56425/56650	TRBI	26
109,538	158,750	23,020	37431 A/37625	TRBI	25
109,538	158,750	23,020	37431/37625	TRBI	25
109,538	158,750	23,020	F 15165	TRBS	34
110,000	165,000	35,000	JM 822049/ JM 822010	TRBI	31
110,000	170,000	38,000	32022 XF	TRBM	10
110,000	170,000	47,000	33022 F	TRBM	12
110,000	170,000	146,000	F 200005	WK	138
110,000	180,000	47,000	JHM 522649/ JHM 522610	TRBI	29
110,000	200,000	41,000	30222 F	TRBM	8
110,000	200,000	53,000	NJ 2222 FM/C3	CRB	114
110,000	200,000	56,000	32222 F	TRBM	11
110,000	240,000	80,000	NJ 2322 FM/C3	CRB	114
114,300	152,400	21,432	L 623149/ L 623110	TRBI	29
114,300	177,800	41,275	64450/64700	TRBI	26
114,970	-	41,270	CONE 64452 A	CONE	48
114,975	177,800	41,275	F 15388	TRBS	40
117,475	180,975	34,925	68462/68712	TRBI	27
120,000	-	48,000	CONE F 15362	CONE	48
120,000	165,000	29,000	32924 F	TRBM	12
120,000	170,000	27,000	JP 12049 A/ JP 12010	TRBI	20
120,000	170,000	27,000	JP 12049/ JP 12010	TRBI	20
120,000	175,030	123,000	F 200028	WK	140
120,000	180,000	28,000	NJ 1024 FM	CRB	114
120,000	180,000	38,000	32024 XF	TRBM	10
120,000	181,000	48,000	F 15385	TRBS	40
120,000	215,000	43,500	30224 F	TRBM	8
127,000	182,562	39,689	48290/48220	TRBI	26
130,000	185,000	29,000	JP 13049/ JP 13010	TRBI	20
130,000	200,000	45,000	32026 XF	TRBM	10
130,000	230,000	43,750	30226 F	TRBM	8

d	D	T	FERSA		PG.
140,000	210,000	45,000	32028 XF	TRBM	10
142,875	200,025	41,275	48684/48620	TRBI	26
152,400	203,200	41,275	LM 330448/ LM 330410	TRBI	28
190,500	266,700	47,625	67885/67820	TRBI	27



14.3 \ Cross part number Cruces de referencias

COMPETITOR	Fersa	PG.
BOWER		
47687/47623 A	47687/47623 A	26
MA 1211 EL	F 19108	124
MA 1211 V1/M1211 V	F 19108	124
MA1211EL	F 19108	124
MU 1309 UM	F 19107	124
MU 1309 UM V1	F 19107	124

FAG		
33014	33014 F	12
201009	JM 714249/JM 714210	29
201029	JF 9549/JF 9510	19
201034	F 15100	136
201037	F 15097	136
201040	JF 4549/JF 4510	19
201043	F 300003	142
201047	JF 4549/JF 4510	19
201050	F 15120	136
201052	33209 F	13
201059	F 15122	136
201067	JM 714249/JM 714210	29
501493	F 15357	106
511134	F 19015	118
511482	HM 911244/HM 911216	31
511687	F 15080	34
512392	47487/47420	25
512533	F 19019	118
518713	F 15280	38
520550	F 19112	124
521618	F 15083	34
523361	F 15258	36
524850	JM 515649/JM 515610	29
528595	F 15272	38
528935	F 15089	34
528946	F 15076	34
528983	F 15051 R	32
529065	F 15075	34
532066	F 16019	82
534565	F 15051 C	32
535000	F 15209	106
535001	F 15210	106
538971	JF 7049 A/JF 7010	19
540106	F 19009	118
540484	F 15036	32
540669	F 15183	34
540733	F 16035	84

COMPETITOR	Fersa	PG.
540763	F 16201	92
540783	F 15071	32
543562	F 15048	32
543805	F 15157	34
543909	F 18011	76
544307	F 16023	82
545312	F 16001	82
545495	F 16046	86
546238	F 16021	82
546439	F 15361	40
546467	F 15041	52
546485	62305 2RS/C3	70
547059	F 16195	92
548083	F 16026	82
561447	F 16018	82
561481	F 16048	86
563147	F 15059	104
563809	F 19081	122
565362	F 19091	122
565636	F 16042	86
566195	F 18021	76
566646	CONE F 15084	48
566719	F 16039	84
566949	F 19063	120
567549	F 15208	36
567918	F 16002	82
568968	JF 6049/JF 6010	19
568980	F 15119	34
572428	F 15029	32
572772	F 16211	94
572813	F 15193	36
574368	F 15116	34
574885	F 15365	153
575194	F 15246	42
575867	F 19089	122
576503	CONE F 15150 A	48
579381	F 15184	34
579557	F 16037	84
580400	F 16020	82
580616	F 15190	34
580989	F 19076	122
581541	F 15273	38
584183	F 16205	94
801136	F 16040	86
801400	F 15257	36
801785	F 15271	36

COMPETITOR	Fersa	PG.
FAG		
803621	F 15104	34
803775	F 16083	88
803837	F 15043	52
804339	F 19042	120
804358	F 15156	34
805045	6217/80 C3	69
805050	F 15270	36
805096	F 15255	36
805097	F 15256	36
805189	F 15323	38
805248	HM 220149/HM 220110	28
805262	F 19001	118
805312	F 15267	36
805449	F 19010	118
805450	F 19039	120
805531	F 300007	142
805532	F 300010	142
805921	F 16057	88
808918	F 200025	140
713606040	KV 377	170
713606050	KA 004	158
713606060	KV 547	175
713606120	KA 002	158
713606140	KA 003	158
713606160	KF 094	161
713606200	KA 001	158
713606260	KF 092	160
713606290	KV 534	174
713606300	KV 398	170
713606340	KV 447	172
713606350	KV 474	173
713606400	KF 510	174
713610020	KF 184	163
713610040	KF 183	163
713610070	KF 308	168
713610100	KF 182	163
713610130	KF 180	163
713610140	KF 179	163
713610160	KF 095	161
713610160	KF 185	163
713610210	KV 284	167
713610220	KV 194	164
713610230	KA 069	160
713610240	KA 005	158
713610290	KF 096	161

COMPETITOR	Fersa	PG.
713610310	KF 181	163
713610320	KV 284	167
713610340	KF 233	165
713610350	KF 306	168
713610360	KF 479	173
713610370	KA 248	166
713610390	KV 250	166
713610420	KF 098	161
713610450	KF 240	165
713610460	KF 241	165
713610470	KV 287	167
713610480	KV 425	171
713610490	KV 286	167
713610500	KV 276	167
713610530	KV 285	167
713610580	KV 518	174
713610610	KV 359	169
713610620	KV 367	169
713610640	KF 421	171
713610660	KV 420	171
713610690	KV 358	169
713610700	KV 395	170
713610710	KF 519	174
713610730	KF 182	163
713610760	KV 394	170
713610770	KV 360	169
713610810	KV 511	174
713610830	KV 361	169
713611410	KA 455	172
713611480	KA 071	160
713611550	KC 256	166
713611570	KA 072	160
713612110	KA 502	174
713613040	KF 130	162
713613070	KA 131	162
713613080	KA 430	171
713613090	KF 129	162
713613130	KA 036	159
713613160	KA 035	159
713613210	KB 217	165
713613220	KC 132	162
713613230	KA 077	160
713613280	KA 034	159
713613340	KV 530	174
713613410	KA 266	166
713613490	KB 318	168

14.3 \ Cross part number

Cruces de referencias

COMPETITOR	Fersa	PG.
FAG		
713613590	KA 268	166
713613640	KV 267	166
713613720	KV 503	174
713613750	KA 392	170
713613780	KF 381	170
713613790	KF 321	168
713613810	KF 380	170
713613830	KF 128	162
713613870	KF 442	172
713614010	KA 349	169
713614030	KF 159	163
713614210	KA 054	159
713615030	KF 227	165
713615090	KF 225	165
713615130	KA 393	170
713615150	KA 214	165
713615210	KA 389	170
713615230	KA 542	175
713615510	KV 226	165
713615530	KV 232	165
713617030	KF 304	168
713617040	KF 102	161
713617070	KV 229	165
713617090	KF 099	161
713617160	KF 320	168
713617260	KV 100	161
713617270	KV 260	166
713617350	KV 505	174
713617360	KF 101	161
713617400	KV 457	172
713617410	KV 449	172
713617450	KF 426	171
713617840	KF 525	174
713617850	KV 501	174
713618020	KF 259	166
713618020	KF 456	172
713618040	KF 310	168
713618100	KA 065	160
713618110	KA 066	160
713618110	KA 067	160
713618170	KV 451	172
713618210	KC 174	163
713618270	KF 173	163
713618310	KF 466	172
713618370	KF 352	169

COMPETITOR	Fersa	PG.
713618400	KC 488	173
713618550	KF 298	167
713618560	KF 197	164
713618570	KV 537	175
713618630	KV 401	170
713618660	KF 429	171
713618670	KV 353	169
713618680	KV 482	173
713618740	KA 067	160
713618760	KF 309	168
713618770	KF 370	170
713618780	KF 382	170
713618860	KF 316	168
713618870	KV 507	174
713618900	KA 070	160
713618970	KV 528	174
713619010	KA 545	175
713619050	KV 230	165
713619060	KV 231	165
713619080	KV 120	161
713619090	KF 119	161
713619100	KA 086	160
713619130	KA 022	158
713619140	KA 190	164
713619170	KF 121	161
713619210	KC 188	164
713619230	KA 187	164
713619240	KA 186	164
713619280	KV 228	165
713619290	KB 491	173
713619300	KA 023	158
713619410	KV 122	162
713619420	KV 123	162
713619430	KV 490	173
713619450	KV 336	168
713619470	KV 513	174
713619480	KV 412	171
713619490	KV 412	171
713619540	KA 423	171
713620010	KA 052	159
713620020	KA 053	159
713620030	KF 441	172
713620130	KA 254	166
713620140	KA 050	159
713620310	KF 452	172
713622140	KB 443	172

COMPETITOR	Fersa	PG.
FAG		
713622150	KB 416	171
713623020	KA 061	159
713623030	KB 062	160
713623050	KC 223	165
713623060	KF 301	167
713623090	KC 265	166
713623100	KC 444	172
713623150	KC 419	171
713623300	KC 224	165
713623430	KC 522	174
713623440	KC 463	172
713623560	KF 417	171
713625120	KA 413	171
713625140	KA 405	171
713626040	KV 489	173
713626080	KV 521	174
713626090	KB 365	169
713626100	KA 407	171
713626110	KA 397	170
713626480	KA 397	170
713630030	KF 155	163
713630050	KF 195	164
713630060	KF 313	168
713630090	KV 275	167
713630100	KC 146	162
713630120	KC 147	162
713630130	KC 148	162
713630150	KC 149	162
713630160	KF 150	162
713630170	KV 152	162
713630180	KB 048	159
713630180	KB 192	164
713630200	KA 042	159
713630210	KA 043	159
713630220	KA 044	159
713630250	KB 090	160
713630260	KB 046	159
713630270	KB 047	159
713630300	KB 193	164
713630310	KV 157	163
713630330	KA 255	166
713630350	KV 156	163
713630370	KF 314	168
713630430	KA 476	173
713630440	KA 091	160
713630480	KA 049	159

COMPETITOR	Fersa	PG.
713630510	KV 546	175
713630530	KV 114	161
713630540	KV 305	168
713630550	KA 269	166
713630560	KV 258	166
713630570	KV 236	165
713630580	KF 113	161
713630630	KV 243	165
713630640	KV 244	165
713630650	KV 246	166
713630710	KF 312	168
713630730	KV 440	172
713630760	KF 289	167
713630770	KV 445	172
713630780	KB 344	169
713630790	KB 293	167
713630800	KB 278	167
713630810	KB 402	170
713630820	KV 290	167
713630830	KF 277	167
713630840	KF 351	169
713630850	KF 366	169
713630870	KV 492	173
713630880	KV 535	175
713630900	KF 375	170
713630920	KF 371	170
713630950	KB 350	169
713630970	KB 364	169
713630980	KV 520	174
713630990	KF 539	175
713640010	KV 294	167
713640030	KV 435	172
713640080	KF 543	175
713640100	KF 500	174
713640180	KF 143	162
713640190	KF 111	161
713640250	KV 219	165
713640260	KV 144	162
713640280	KF 112	161
713640310	KF 354	169
713640320	KB 368	170
713640330	KB 424	171
713640390	KB 295	167
713640400	KB 296	167
713640420	KV 460	172
713640450	KV 548	175
713640460	KV 458	172

14.3 \ Cross part number

Cruces de referencias

COMPETITOR	Fersa	PG.
FAG		
713640470	KB 357	169
713640480	KB 369	170
713640500	KF 399	170
713640510	KV 410	171
713640540	KF 473	173
713644010	KA 404	171
713644020	KV 279	167
713644030	KV 247	166
713644040	KV 196	164
713644060	KV 199	164
713644070	KV 198	164
713644080	KF 292	167
713644090	KV 343	169
713644100	KF 342	169
713644110	KF 341	169
713644120	KF 340	169
713644130	KF 315	168
713644140	KB 339	169
713644150	KF 137	162
713644160	KF 133	162
713644170	KF 134	162
713644180	KF 153	162
713644190	KF 138	162
713644220	KB 338	169
713644230	KV 337	169
713644260	KV 336	168
713644270	KV 335	168
713644290	KF 334	168
713644310	KV 333	168
713644320	KV 332	168
713644330	KV 331	168
713644340	KV 330	168
713644480	KA 040	159
713644520	KA 039	159
713644540	KV 135	162
713644550	KV 235	165
713644560	KV 202	164
713644570	KV 252	166
713644650	KF 136	162
713644660	KF 376	170
713644670	KF 448	172
713644690	KV 531	174
713644770	KV 481	173
713644830	KF 428	171
713644850	KV 524	174
713649240	KF 104	161

COMPETITOR	Fersa	PG.
713649250	KF 107	161
713649260	KF 396	170
713649270	KF 106	161
713649280	KF 348	169
713649300	KF 110	161
713649320	KF 109	161
713649330	KF 470	173
713649350	KV 374	170
713649370	KV 462	172
713649380	KV 432	171
713649390	KF 418	171
713649410	KV 239	165
713650060	KF 145	162
713650070	KB 078	160
713650140	KA 041	159
713650160	KF 142	162
713650210	KA 089	160
713650250	KV 215	165
713650260	KF 141	162
713650270	KA 073	160
713650290	KB 008	158
713650310	KA 079	160
713650330	KA 272	166
713650410	KA 058	159
713650420	KA 013	158
713650430	KA 080	160
713650520	KV 403	171
713650540	KV 459	172
713660030	KV 514	174
713660040	KV 271	166
713660050	KF 176	163
713660080	KV 234	165
713660110	KA 068	160
713660120	KV 242	165
713660130	KF 302	167
713660190	KF 175	163
713660210	KV 467	172
713660230	KA 211	164
713660260	KA 212	164
713660280	KV 177	163
713660310	KV 249	166
713660340	KV 480	173
713660370	KV 245	165
713660380	KF 516	174
713660410	KV 178	163
713661020	KV 408	171
713665020	KF 433	171

COMPETITOR	Fersa	PG.
FAG		
713665020	KF 504	174
713665300	KV 506	174
713667020	KA 515	174
713667030	KB 422	171
713667050	KF 127	162
713667060	KV 297	167
713667070	KV 431	171
713667140	KV 105	161
713667180	KV 108	161
713667190	KV 532	174
713667220	KV 238	165
713667230	KF 303	167
713667300	KA 033	159
713667310	KF 450	172
713667320	KB 345	169
713667370	KA 028	158
713667380	KA 087	160
713667400	KA 025	158
713667420	KA 029	158
713667430	KA 027	158
713667450	KA 030	159
713667470	KA 189	164
713667520	KA 026	158
713667560	KA 126	162
713667570	KA 032	159
713667580	KB 125	162
713667600	KA 273	166
713667740	KF 280	167
713667780	KV 472	173
713667790	KF 378	170
713667800	KA 406	171
713667820	KA 414	171
713667870	KF 124	162
713667890	KF 300	167
713670020	KV 439	172
713670030	KV 363	169
713678020	KA 020	158
713678030	KB 191	164
713678040	KF 115	161
713678040	KF 327	168
713678050	KF 116	161
713678080	KA 018	158
713678090	KA 019	158
713678100	KF 282	167
713678110	KF 201	164
713678120	KA 499	173

COMPETITOR	Fersa	PG.
713678140	KA 017	158
713678150	KA 075	160
713678190	KA 015	158
713678250	KA 014	158
713678280	KA 082	160
713678290	KA 257	166
713678300	KA 083	160
713678320	KA 021	158
713678340	KV 220	165
713678360	KV 222	165
713678400	KD 117	161
713678400	KD 118	161
713678410	KF 329	168
713678420	KA 084	160
713678430	KV 328	168
713678440	KF 549	175
713678500	KA 085	160
713678600	KF 453	172
713678610	KB 263	166
713678650	KV 291	167
713678660	KV 326	168
713678670	KV 325	168
713678700	KV 221	165
713678730	KV 323	168
713678730	KV 324	168
713678750	KA 081	160
713678760	KA 076	160
713678770	KA 347	169
713678790	KV 322	168
713678870	KF 385	170
713678890	KV 484	173
713678900	KV 387	170
713680110	KA 063	160
713680160	KF 172	163
713690010	KV 163	163
713690060	KF 465	172
713690070	KF 261	166
713690080	KF 468	173
713690090	KA 024	158
713690110	KA 213	164
713690120	KA 055	159
713690130	KA 056	159
713690150	KA 057	159
713690160	KF 161	163
713690170	KF 160	163
713690180	KC 477	173
713690190	KC 205	164

14.3 \ Cross part number

Cruces de referencias

COMPETITOR	Fersa	PG.
FAG		
713690200	KC 253	166
713690210	KA 210	164
713690230	KV 164	163
713690240	KV 162	163
713690260	KV 204	164
713690320	KB 011	158
713690330	KA 009	158
713690360	KV 544	175
713690380	KA 169	163
713690420	KB 012	158
713690430	KA 010	158
713690470	KA 170	163
713690490	KA 200	164
713690500	KF 165	163
713690500	KF 168	163
713690510	KF 166	163
713690540	KF 264	166
713690550	KV 237	165
713690600	KV 218	165
713690610	KF 167	163
713690670	KF 281	167
713690700	KF 536	175
713690710	KV 251	166
713690730	KV 409	171
713690750	KF 346	169
713690760	KV 411	171
713690780	KF 270	166
713690800	KF 373	170
713690810	KF 471	173
713690830	KB 356	169
713690840	KB 362	169
713690850	F 300006	142
713690860	KF 288	167
713690920	KV 523	174
713690930	KB 390	170
713690940	KB 372	170
713696100	KF 203	164
713697030	KA 517	174
713697040	KA 533	174
713697070	KF 494	173
7220688100	F 15048	32
26-1789A	F 17108 K	132
30305A	30305 F	8
32210A	32210 F	10
32314 A	32314 F	11
33020. 561694	33020 F 561694	12

COMPETITOR	Fersa	PG.
33021. 580938	F 15239	36
33024/588641	F 15385	40
4209 BTVH	F 18009	76
508204 E.TVP	F 19044	120
509333 A	F 15082	34
510148 A	F 19012	118
510148 B	F 19043	120
512099 TVP2	F 19011	118
512099TVP2	F 19011	118
518772A	L 45449/L 45410	25
521471 A	F 15046	32
522380/33211	F 15047	32
524625B.M	F 19106	124
524851A	JM 718149 A/JM 718110	30
528983 B	F 15051 R	32
530689 B	F 15141	106
536906C	F 18024	76
539090M	F 19105	124
539351A	F 19037	120
539859D	F 19010	118
540484A.H49A	F 15036	32
540669.TR1PW	F 15183	34
541153 A	F 16002	82
541521 C	F 16032	84
542186 A	F 16036	84
543359 B	F 16051	86
544872.E23	F 18062	78
547103 E	F 16082	88
547103 E	F 16084	90
548866 A	F 15165	34
558841.04.LTR1	F 15346	40
562398 A	F 16031	84
562495C	F 15108	42
562830 A	F 15158	34
562830A	F 15158	34
563007/801464	F 15298	38
563809 A	F 19081	122
564725 AB	F 16085	90
564734.H195	F 300001	142
566074.H195	F 200016	138
566193.H195	F 200018	140
566283.01.H195	F 200017	140
566283.H195	F 200017	140
566425.H195	F 200014	138
566426.H195	F 200013	138
566427.H195	F 200015	138
566616 B	F 19008	118

COMPETITOR	Fersa	PG.
FAG		
566830.H195	F 200028	140
566834.H195	F 200019	140
566847.H195	F 200031	140
567447 B	F 16038	84
568742 A	F 15191	42
569868.H195	F 200029	140
570530.H195	F 200025	140
571762.01.H195	F 15097	136
571762.H195	F 15097	136
572813 A	F 15193	36
574795A	F 16034	84
574821 A	F 15040	32
575725.F51	F 15159	34
576791.H131AB	F 15386	40
576791.H131AB + 31311 F	F 15387	153
579205.H195	F 300003	142
579943 B	F 16086	90
580616 TR1	F 15190	34
580779 A	F 15115	34
581079 C	F 200013	138
6206.2RSR.C3	6206 2RS/C3	68
6213 2RSR NR/C3	6213 2RS NR/C3	69
713 6261 40	F 16207	94
713 6308 10	F 15174	54
713 6911 10	F 15302	54
800574 A	F 18042	76
800792 D	F 200014	138
801794 B	F 15253	36
801974AE.H195	F 300005	142
803194 A	F 15125	136
803194.26	F 15125	136
803750 B	F 200004	138
804162 A	F 200005	138
805003A.H195	F 15100	136
805003CA.H195	F 15300	136
805011 C	F 15126	136
805012.06.H195	F 15122	136
805015/801400	F 15254	36
805046/801464	F 15192	42
805092 C	F 15127	136
805092.07	F 15127	136
805532.01.H195	F 300010	142
F-568895.TR1	F 15311	42
F-571090.RTR1-DY-W61	CONE 65237	26

COMPETITOR	Fersa	PG.
F-571514.RTR1-DY-W61	CONE JM 714249	29
F-571752.03.TR1-DY-H73	F 15382	40
F-580791.TR1	F 15348	40
F-580794.TR1	F 15347	40
F-585057.02	F 15388	40
F-805576.04	F 15326	38
K.33885.33822	33885/33822	24
NUP 524213 M	F 19022	118
NUP311EN-M1-C3	NUP 311 FMNR/C3	116
T2EE060	JF 6049/JF 6010	19
T2EE100	JF 10049/JF 10010	20
T5ED100.576376	F 15200	36
Z 579943.06	F 16086	90
Z-504376.02	F 15322	38
Z-512099.ZL-TVP2	F 19011	118
Z-524625.02.ZL-M	F 19106	124
Z-524625.03.ZL	F 19106	124
Z-539090.01	F 19105	124
Z-539090.ZL-M	F 19105	124
Z-539859.ZL	F 19010	118

FLT

CBK 238	F 19030	120
---------	----------------	-----

INA

31173	F 19019	118
87486	F 19075	122
553935	F 18052	78
561521	F 19044	120
722013010	F 17101 K	132
722018510	F 17098 K	130
722073010	F 15116	34
712 1572 10	F 18021	76
722 0183 10	F 19075	122
F 110487.1	F 16020	82
F 113021	F 18040	106
F 113175	F 16030	84
F 113519	F 15141	106
F 210540	F 19013	118
F 211408.5	F 19062	120
F 211413.2	F 19061	120
F 224451.04	F 19090	122
F 230271	F 17089 K	130
F 237594	F 19069	120
F 43710.1	F 19066	120

14.3 \ Cross part number

Cruces de referencias

COMPETITOR	Fersa	PG.
INA		
F 44501	F 19031	120
F 45385	F 18039	76
F 45721	F 16001	82
F 45747.2	F 16035	84
F 45814	F 19015	118
F 45815	F 15139	106
F 45815.1	F 15140	106
F 45864.1	F 19020	118
F 45920.2	F 16036	84
F 45951	F 16002	82
F 64843.1	F 15034	104
F 88545	F 19037	120
F 88816.2	F 19038	120
F 90836.1A	F 19016	118
F 93666.2	F 19048	120
F-110214.1	F 19096	122
F-202742	F 17061 K	130
F-202961.1	F 17063 K	130
F-203030	F 17095 K	130
F-203531.1	F 17108 K	132
F-203535	F 17093 K	130
F-204691	F 17076 K	130
F-205901.01	F 17056 K	128
F-207054	F 17033 K	128
F-208323	F 17110 K	132
F-208939.03	F 17094 K	130
F-209976	F 17057 K	130
F-209977	F 17058 K	130
F-210326.01	F 17059 K	130
F-211412.03	F 17038 K	128
F-212874.01	F 17039 K	128
F-212875.01	F 17040 K	128
F-217112	F 17041 K	128
F-219518	F 17034 K	128
F-221302.01	F 19097	122
F-224446	F 17077 K	130
F-224448.K-HLA	F 17078 K	130
F-225955	F 17079 K	130
F-226559.02-0010	F 19069	120
F-227124.K-HLA	F 17080 K	130
F-227348	F 17092 K	130
F-227349	F 17091 K	130
F-227511.06	F 17097 K	130
F-227638	F 17096 K	130
F-229852	F 19087	122

COMPETITOR	Fersa	PG.
F-237594 + F-226559.41	F 19116	124
F-239307	F 17105 K	132
F-44343	F 15059	104
F-45073	RMS 9	75
F-45809	F 19011	118
F-45809.01.ZL	F 19011	118
F-45809.01.ZL-AM	F 19011	118
F45818	F 19043	120
F-45818.01	F 19043	120
F45917	F 19002	118
F-53597	F 19091	122
F-53960	F 17103 K	132
F-57368.01	F 17031 K	128
F-58242	F 17051 K	128
F-58637	F 17101 K	132
F-58723	F 17052 K	128
F-59437	F 17104 K	132
F-80318	F 17090 K	130
F-84156	F 17102 K	132
F-87259	F 17053 K	128
F-87934	F 17098 K	130
F-88416	F 17100 K	132
F-89034	F 19111	124
F-92625	F 17032 K	128
F-934249.01	F 19005	118
F-95451.02	F 17035 K	128
FW404820	F 17106 K	132
K 45X53X21 A	F 17054 K	128
K 62X70X40 ZW	F 17099 K	130
K75X83X40 ZW	F 17064 K	130
V 54276	F 19045	120

IRB		
IR 108	F 15031	104
IR 128	F 15005	106
IR 164	F 18012	106
IR 2043	F 15036	32
IR 2056	365/362	14
IR 2562	F 15029	32
IR 8006	F 16042	86
IR 8014	F 18011	76
IR 8026	F 16002	82
IR 8040	F 16001	82
IR 8041	F 16019	82
IR 8042	F 16021	82
IR 8048	F 16044	86

COMPETITOR	Fersa	PG.
IRB		
IR 8051	F 16018	82
IR 8052	F 16035	84
IR 8055	F 16026	82
IR 8065	F 16023	82
IR 8066	F 16030	84
IR 8085	F 16036	84
IR 8086	F 16048	86
IR 8088	F 16031	84
IR 8091	F 16022	82
IR 8095	F 16039	84
IR 8101	F 16051	86
IR 8505	F 16010	82
IR 8509	F 16046	86
IR 8513	F 16032	84
IR 8530	F 16038	84
IR 8566	F 18009	76
IR 8583	F 16041	86
IR 8591	F 16033	84
IR 8593	F 16055	86
IR 8597	F 16063	88
IR 8603	F 16037	84
IR 8618	F 16056	88
IR 8622	F 16020	82
IR 8650	F 16081	88
IR 8655	F 16034	84
IR 8668	F 16040	86
IR 8737	F 16054	86
IR 8740	F 16029	82
IR174	F 18031	106

ISO		
T2BC055	32911 F	12
T2CC050	JLM 104948/JLM 104910	28
T2CC120	32924 F	12
T2CD025	32205 F	10
T2CE040	33108 F	12
T2CE050	33010 F	12
T2CE055	33011 F	12
T2CE065	33013 F	12
T2CE075	33015 F	12
T2CE085	33017 F	12
T2CE090	33018 F	12
T2CE095	33019 F	12
T2CE100	33020 F	12
T2CE100	33020 F 561694	12
T2DB017	30203 F	8

COMPETITOR	Fersa	PG.
T2DB020	30204 F	8
T2DD020	32204 F	10
T2DD050	JM 205149/JM 205110	28
T2DD055	JM 207049/JM 207010	28
T2DD055A	JM 207049 A/JM 207010	28
T2DD065	JD 6549/JD 6510	19
T2DE025	33205 F	13
T2DE030	33206 F	13
T2DE035	33207 F	13
T2DE040	33208 F	13
T2DE105	33021 F	12
T2DE110	33022 F	12
T2ED045	JF 4549/JF 4510	19
T2ED050	JF 5049/JF 5010	19
T2ED060	F 15273	38
T2ED065	JH 211749/JH 211710	28
T2ED070	JF 7049/JF 7010	19
T2ED070A	JF 7049 A/JF 7010	19
T2ED095	JF 9549/JF 9510	19
T2EE040	JF 4049/JF 4010	19
T2EE060	JF 6049/JF 6010	19
T2EE100	JF 10049/JF 10010	20
T2FB015	30302 F	8
T2FB017	30303 F	8
T2FB020	30304 F	8
T2FB025	30305 F	8
T2FB030	30306 F	8
T2FB035	30307 F	8
T2FB040	30308 F	9
T2FB050	30310 F	9
T2FB055	30311 F	9
T2FB060	30312 F	9
T2FD020	32304 F	11
T2FD025	32305 F	11
T2FD030	32306 F	11
T2FD040	32308 F	11
T2FD045	32309 BF	11
T2FD050	32310 F	11
T2FD055	32311 F	11
T2FD060	32312 F	11
T2FE035	32307 F	11
T2GB065	30313 F	9
T2GB070	30314 F	9
T2GB075	30315 F	9
T2GB080	30316 F	9
T2GD065	32313 F	11
T2GD070	32314 F	11

14.3 \ Cross part number

Cruces de referencias

COMPETITOR	Fersa	PG.
ISO		
T2GD075	32315 F	11
T2GD080	32316 F	11
T2GD085	32317 F	11
T3CB055	JLM 506849/JLM 506810	29
T3CC020	32004 XF	9
T3CC025	30205 F	8
T3CC045	32009 XF	10
T3CC050	32010 XF	10
T3CC055	32011 XF	10
T3CC080	32016 XF	10
T3CC090	32018 XF	10
T3CD040	32008 XF	10
T3CE045	33109 F	12
T3CE050	33110 F	12
T3CE055	33111 F	12
T3CE060	33112 F	12
T3DB030	30206 F	8
T3DB035	30207 F	8
T3DB040	30208 F	8
T3DB045	30209 F	8
T3DB050	30210 F	8
T3DB055	30211 F	8
T3DC030	32206 F	10
T3DC035	32207 F	10
T3DC040	32208 F	10
T3DC045	32209 F	10
T3DC050	32210 F	10
T3DC055	32211 F	10
T3DC065	JM 511946/JM 511910	29
T3DD080	JM 515649/JM 515610	29
T3DD085	JHM 516849/JHM 516810	29
T3DE045	33209 F	13
T3DE050	33210 F	13
T3DE055	33211 F	13
T3DE065	33113 F	12
T3DE070	33114 F	12
T3DE075	33115 F	12
T3DE080	33116 F	12
T3DE085	33117 F	12
T3DE090	33118 F	12
T3EB060	30212 F	8
T3EB065	30213 F	8
T3EB070	30214 F	8
T3EB080	30216 F	8
T3EB085	30217 F	8
T3EC060	32212 F	10

COMPETITOR	Fersa	PG.
T3EC065	32213 F	11
T3EC070	32214 F	11
T3EC080	32216 F	11
T3EC080	33216 F 573810	13
T3EC085	32217 F	11
T3EE060	33212 F	13
T3EE065	33213 F	13
T3EE070	33214 F	13
T3EE075	33215 F	13
T3EE080	33216 F	13
T3EE085	33217 F	13
T3FB090	30218 F	8
T3FB095	30219 F	8
T3FB100	30220 F	8
T3FB105	30221 F	8
T3FB110	30222 F	8
T3FC090	32218 F	11
T3FC095	32219 F	11
T3FC100	32220 F	11
T3FC105	32221 F	11
T3FC110	32222 F	11
T3FE100	33220 F	13
T4CB100	JP 10049/JP 10010	20
T4CB120	JP 12049/JP 12010	20
T4CB120A	JP 12049 A/JP 12010	20
T4CB130	JP 13049/JP 13010	20
T4CC025	32005 XF	9
T4CC028	320/28 XF	9
T4CC030	32006 XF	9
T4CC032	320/32 XF	9
T4CC035	32007 XF	10
T4CC060	32012 XF	10
T4CC065	32013 XF	10
T4CC070	32014 XF	10
T4CC075	32015 XF	10
T4CC085	32017 XF	10
T4CC095	32019 XF	10
T4CC100	32020 XF	10
T4CD065	JLM 710949 C/JLM 710910	29
T4CD070	JLM 813049/JLM 813010	30
T4CD075	JM 714249/JM 714210	29
T4DB075	30215 F	8
T4DC070	JM 612949/JM 612910	29
T4DC075	32215 F	11
T4DC090	JM 718149/JM 718110	30
T4DC090A	JM 718149 A/JM 718110	30

COMPETITOR	Fersa	PG.
ISO		
T4DC095	JM 719149/JM 719113	30
T4DC100	JM 720249/JM 720210	30
T4DC105	32021 XF	10
T4DC110	32022 XF	10
T4DC120	32024 XF	10
T4DD100	JHM 720249/JHM 720210	30
T4FB120	30224 F	8
T4FB130	30226 F	8
T4FD050	JHM 807045/JHM 807012	30
T5CD025	32205 BF	10
T5FD030	32306 BF	11
T5FD045	32309 F	11
T5FD060	32312 BF	11
T5GD065	32313 BF	11
T5GD070	32314 BF	11
T7FB025	31305 F	9
T7FB030	31306 F	9
T7FB035	31307 F	9
T7FB040	31308 F	9
T7FB045	31309 F	9
T7FB050	31310 F	9
T7FB055	31311 F	9
T7FB060	31312 F	9
T7FC045	JW 4549/JW 4510	19
T7FC050	JW 5049/JW 5010	19
T7FC055	JW 5549/JW 5510	19
T7FC060	JW 6049/JW 6010	19
T7FC070	JW 7049/JW 7010	19
T7FC080	JW 8049/JW 8010	19
T7GB065	31313 F	9
T7GB070	31314 F	9
T7GB075	31315 F	9
T7GB090	31318 F	9
TCCE080	33016 F	12
TCFB045	30309 F	9

KBC		
3780 F1	F 15054/3720	32
RCHL 38KW01C9	F 15055/LM 29710	32

KOYO		
57355	F 15199	36
57518	F 15330	38
57620	F 15109	34

COMPETITOR	Fersa	PG.
KOYO		
83549	F 18039	76
573315	F 15036	32
4304555	F 17109 K	132
05NU0618-IVH	F 19093	122
2DACF028G 6R	F 16210	94
30 BG 05 S5G - 2DST2	F 16098	100
32012 J/IB	F 15329	38
40 BD 45 T12	F 16189	100
40 BD 49 AW	F 16190	100
45CLM806649LFTL2/Z	F 15295	38
57414 / LM 300811	F 15003	32
57508 L2/28521	F 15278	38
57518/TR1312	F 15380	40
57518/TR1312/1YD	F 15330	38
6210NRZ	F 18032	76
6217 3BBNCS 9	F 18036	76
83 A 5518	F 16102	100
83C062D	F 18066	78
BD 30 - 11 A	F 16104	100
CT 1310	F 15118	106
CT1310 ARSEDCS23	F 18031	106
DAC 3869W 3CS84	F 16218	94
DAC2753	F 15128	52
DAC286142 AW	F 16077	88
DAC3052- 32 RR9 DS 10Z	F 16097	100
DAC3555 RD 3H - 83 A 694	F 16100	100
DAC3564A1	F 16200	92
DAC35720034 A	F 16201	92
DAC3871W2CS70	F 16120	92
DAC3872W 8CS81	F 16068	88
DAC3872W10CS42	F 16124	92
DAC3874W 6CS84	F 16034	84
DAC3972AWC4 CS49	F 16036	84
DAC40440036	F 16080	88
DAC4060 M1	F 16090	90
DAC40740034 / 36	F 16091	90
DAC40740036	F 16080	88
DAC40740042 B	F 16079	88
DAC4276W	F 16195	92
DAC43820045	F 16078	88
DAC4584W-1CS81	F 16216	94
DAC4781W	F 16199	92
DG 4094 W	F 18050	78
DU5496-6	F 15324	54

14.3 \ Cross part number

Cruces de referencias

COMPETITOR	Fersa	PG.
KOYO		
DU60108 8	F 15120	136
HIC 57620/3320	F 15109	34
LM 806649/57591N	F 15295	38
SB1716BBNS	F 18037	76
ST 2455	CONE F 15084	48
ST 4276 C / ST 4276 A	F 15112	34
ST 4276 C/A	CONE F 15111	48
STA 3072	F 15203	36
TR 0506 R	F 15001	32
TR 070904 1	F 15202	36
TR 100802	F 15201	36
TR0607J-1	F 15203	36
TRA 0607 R	F 15002	32

NACHI		
30 BG 055 2G - 2DS	F 16097	100
30 BG 055 5G - 2DS	F 16098	100
30 BG S 12G - 2DS	F 16104	100
31 RUKS52N C3	F 19079	122
35 BG 055 10G 2DL	F 16100	100
35 BG 055 7G 2DS	F 16099	100
35 BG 52 22 2DS	F 16101	100
38 BWV07 10G	F 16124	92
40 BG 055 2G - 2DS	F 16189	100
40 BG 620 20 - 2DL	F 16103	100
40 BG S 12G - 2DS	F 16190	100
40 BG S1 1G - 2DS	F 16102	100
NUPK 2205 S1 NR	F 19023	118
NUPK 2205 S13	F 19004	118

NATIONAL		
510002	F 16120	92
510004	F 16039	84
510006	F 16078	88
510007	F 16068	88
510008	F 16058	88
510009	F 16081	88
510010	F 16088	90
510014	F 16200	92
510015	F 16117	92
510016	F 16091	90
510019	F 16054	86
510024	F 16035	84
510028	F 16199	92
510029	F 16055	86
510030	F 16052	86

COMPETITOR	Fersa	PG.
510032	F 16198	92
510051	F 16085	90
510052	F 16037	84
510055	F 16057	88
510057	F 16197	92
510060	F 16196	92
510061	F 16080	88
510087	F 16056	88
510089	F 16193	92
511020	F 16032	84
513006	F 16195	92
513021	F 16023	82
513031	F 16077	88
513036	F 16090	90
513053	F 16041	86
513058	F 16194	92
513073	F 16048	86
513113	F 16036	84
514002	F 16034	84
516005	F 15130	52
516007	F 15067	52

NSK		
27 BWK 04D3	F 16094	90
28 BWK 12	F 16095	90
28KW0165SA	F 15056	32
29586 A / 29522	F 15304	38
30 BD 40 A - T1Z DDF1	F 16098	100
30 BD 5222 FX	F 16097	100
35 BD 219T - 1Z DDU K8	F 16100	100
35 BD 5020 DUK	F 16099	100
35 BD 52 22 DF X7	F 16101	100
35BWD01C	F 16201	92
36BWD04CA5	F 16115	90
38BWD06D A CA 01	F 16058	88
38BWD09ACA128	F 16120	92
38BWD28DCA98-01LB	F 16214	94
38KW01C9	F 15055 / LM 29710	32
40 BD 45 T12 DDU	F 16189	100
40 BD 49 AWT12 DDU	F 16190	100
40 BD 49V	F 16103	100
40 BW06CG50	F 18051	78
40 BWD 06	F 16081	88
40 BWD 12	F 16079	88
40 BWD 15 A	F 16080	88
40 BWD 17DCA116*SA01	F 16217	94
40BWD05CA60	F 16041	86

COMPETITOR	Fersa	PG.
NSK		
40KWD02	F 15129	52
41KWD01G3	F 15015	52
42 BWD 06CA98	F 16085	90
42KWD08A	F 15130	52
43 BWD 06	F 16078	88
43 BWD 12A JB 5C01	F 16196	92
43 KWD 07AU42CA	F 15160	52
43BWD08CA103	F 16052	86
47 KWD 02 AP	F 15268	54
49BWD01BCA116	F 16109	90
49BWD03CA	F 16208	94
4UA20/KWD 10	F 15218	54
50KW01	F 15054/3720	32
54KWH02	F 15146	52
AU 0501 NTN	F 16129	92
B17 126 DDWC3	F 18020	76
B17-99 D	6304/17 B17 2RS	71
B25-299DWA18	F 18058	78
BL 210 ZNR C3	F 18041	76
DF 0865	F 16102	100
R35-24	F 15202	36

NTN		
2TS2 - DF 0882 LL BCS	F 16189	100
30 BG 04 S15G - 2DST	F 16100	100
30 TM11NC3 UR UMMS	F 18047	78
32 TM11NC3 UR UMMS 806	F 18048	78
33212.1/ECO CR-1187.1	F 15332	38
40 BD 219T 12 DDU	F 16102	100
4T 45285 APX1 /4T CR 1091 PX1	F 15212	42
5206 #37	F 16104	100
5908 - 2RSWE	F 16190	100
6215/72 C3	F 18060	78
AU 0501	F 16129	92
AU 0933	F 16193	92
CR 1252	F 15088	34
DAC 4T CR1	F 15149	52
DE 08A48LLCS46PX1 / L260	F 16117	92
ECO CIR 0805.2	CONE F 15249	48
ECO CIR 0810.1	CONE F 15292	48
ECO CR 12A 06 1	F 15245	36
ECO CR-12A17.1	F 15334	38
ETA CIR 1006.1	CONE F 15244	48

COMPETITOR	Fersa	PG.
ETA CIR 1010 1	CONE F 15113	48
ETA CIR 1012	CONE F 15333	48
ETA CIR 1104	CONE F 15111	48
ETA CIR-1106	CONE F 15269	48
ETA CR 05A22STPX1	F 15196	42
TMB 311 X13 C3	F 18042	76

OPTIMAL		
100002	KA 069	160
100003	KF 421	171
100007	KV 425	171
100013	KV 394	170
100014	KF 095	161
100022	KF 182	163
100053	KV 250	166
100090	KF 096	161
100098	KF 098	161
100099	KF 306	168
100206	KF 233	165
101010	KF 179	163
101016	KF 181	163
101017	KV 359	169
101024	KF 183	163
101025	KV 518	174
101027	KV 287	167
101029	KV 285	167
101044	KF 180	163
101064	KA 071	160
101108	KA 455	172
101111	KF 308	168
101113	KF 184	163
101147	KF 185	163
101250	KA 502	174
101699	KV 360	169
102008	KA 005	158
102011	KV 276	167
102019	KV 361	169
102019	KV 367	169
102041	KF 479	173
102055	KA 248	166
102060	KA 072	160
102071	KV 395	170
102075	KV 284	167
102077	KV 286	167
102079	KV 420	171
102094	KC 256	166
102097	KF 519	174

14.3 \ Cross part number

Cruces de referencias

COMPETITOR	Fersa	PG.
OPTIMAL		
102115	KV 194	164
102213	KV 358	169
102497	KV 511	174
131129	KF 240	165
132131	KF 241	165
191272	KA 070	160
192274	KC 488	173
200020	KA 039	159
201031	KV 247	166
201032	KF 134	162
201033	KV 196	164
201035	KV 198	164
201040	KF 133	162
201043	KV 199	164
201084	KV 135	162
201085	KF 315	168
201087	KF 342	169
201089	KF 340	169
201095	KF 292	167
201210	KF 137	162
201228	KF 138	162
201262	KA 404	171
201517	KV 343	169
201621	KV 333	168
201623	KV 332	168
201691	KV 335	168
201996	KA 040	159
202021	KB 338	169
202023	KV 337	169
202059	KV 279	167
202101	KB 339	169
202140	KV 235	165
202142	KV 202	164
202168	KF 136	162
202218	KV 252	166
202224	KF 341	169
202286	KV 524	174
202519	KV 336	168
202625	KV 330	168
202627	KV 331	168
300004	KA 075	160
300052	KA 014	158
300062	KA 083	160
301006	KA 019	158
301018	KA 015	158
301034	KA 018	158

COMPETITOR	Fersa	PG.
301038	KA 081	160
301039	KF 201	164
301045	KF 282	167
301118	KA 085	160
301132	KF 115	161
301132	KF 327	168
301151	KA 499	173
301180	KA 020	158
301182	KF 116	161
301183	KF 329	168
301185	KV 291	167
301230	KA 074	160
301280	KA 017	158
301511	KF 549	175
301574	KF 385	170
301583	KV 387	170
301667	KV 322	168
302057	KB 191	164
302057	KB 384	170
302058	KA 021	158
302058	KA 383	170
302074	KA 076	160
302076	KA 082	160
302120	KA 347	169
302122	KA 257	166
302124	KA 084	160
302164	KF 453	172
302166	KB 263	166
302172	KD 117	161
302176	KD 118	161
302186	KV 220	165
302188	KV 221	165
302192	KV 222	165
302197	KV 328	168
302255	KV 325	168
302257	KV 326	168
302577	KV 484	173
302901	KV 324	168
302903	KV 323	168
400051	KF 280	167
400107	KF 127	162
401028	KA 027	158
401042	KA 028	158
401047	KF 450	172
401048	KA 030	159
401078	KA 189	164
401100	KA 087	160

COMPETITOR	Fersa	PG.
OPTIMAL		
401126	KA 029	158
401137	KA 273	166
401157	KA 414	171
401214	KA 033	159
401222	KA 025	158
401501	KA 406	171
402030	KA 026	158
402050	KA 126	162
402063	KB 345	169
402080	KB 125	162
402116	KF 124	162
402117	KB 422	171
402143	KA 515	174
402216	KA 032	159
402243	KF 300	167
402467	KV 408	171
501088	KV 105	161
501112	KV 105	161
501121	KV 238	165
501133	KV 532	174
501136	KV 108	161
501136	KV 297	167
501158	KF 378	170
501161	KV 374	170
501513	KV 432	171
501653	KV 431	171
502066	KF 107	161
502068	KF 104	161
502070	KF 396	170
502072	KF 106	161
502109	KF 303	167
502123	KV 239	165
502125	KF 470	173
502135	KF 274	166
502135	KF 348	169
502138	KF 109	161
502148	KF 110	161
502163	KV 462	172
502252	KV 472	173
502691	KF 418	171
600308	KF 143	162
600334	KF 111	161
600410	KA 063	160
601253	KF 354	169
601306	KF 142	162
601323	KF 313	168

COMPETITOR	Fersa	PG.
601348	KF 543	175
601384	KA 041	159
601440	KF 500	174
601446	KF 172	163
601495	KF 139	162
601675	KF 399	170
601916	KF 145	162
601953	KF 289	167
602251	KV 435	172
602314	KV 219	165
602320	KB 008	158
602322	KF 112	161
602337	KV 114	161
602340	KV 144	162
602345	KV 460	172
602347	KV 275	167
602386	KV 459	172
602388	KV 215	165
602390	KF 141	162
602406	KF 140	162
602414	KA 073	160
602509	KV 548	175
602645	KV 305	168
602669	KB 368	170
602681	KV 410	171
602745	KB 464	172
602746	KV 458	172
602835	KV 507	174
602858	KB 078	160
602859	KA 089	160
602883	KB 369	170
602893	KB 357	169
602955	KV 445	172
602956	KV 290	167
681303	KF 113	161
681325	KA 272	166
681375	KB 295	167
681375	KB 390	170
681471	KB 296	167
681471	KB 372	170
681504	KA 009	158
681506	KA 079	160
681640	KB 011	158
681913	KF 473	173
681923	KB 356	169
682263	KV 294	167
682305	KV 236	165

14.3 \ Cross part number

Cruces de referencias

COMPETITOR	Fersa	PG.
OPTIMAL		
682327	KA 013	158
682329	KA 080	160
682420	KA 010	158
682437	KB 424	171
682492	KA 200	164
682508	KA 058	159
682642	KB 012	158
682925	KB 362	169
700245	KF 371	170
700310	KF 155	163
701247	KF 334	168
701302	KB 048	159
701302	KB 192	164
701302	KF 151	162
701307	KF 195	164
701326	KV 152	162
701332	KC 149	162
701374	KC 148	162
701404	KF 153	162
701424	KF 314	168
701432	KF 150	162
701726	KA 255	166
701837	KF 539	175
701852	KF 312	168
701860	KB 278	167
701860	KB 293	167
701914	KF 277	167
701975	KF 375	170
701977	KF 351	169
701978	KF 366	169
702312	KB 045	159
702312	KB 193	164
702313	KV 546	175
702316	KB 046	159
702321	KV 246	166
702328	KA 044	159
702350	KA 043	159
702352	KB 090	160
702355	KV 243	165
702357	KV 244	165
702380	KV 154	163
702380	KV 258	166
702426	KB 047	159
702436	KA 476	173
702456	KA 091	160
702494	KV 157	163

COMPETITOR	Fersa	PG.
702514	KV 156	163
702586	KA 269	166
702692	KA 049	159
702815	KV 520	174
702817	KA 043	159
702846	KB 344	169
702846	KB 402	170
702866	KV 440	172
702899	KB 193	164
702957	KV 535	175
702958	KV 492	173
702982	KB 350	169
702983	KB 364	169
800304	KF 160	163
800398	KF 166	163
800400	KF 261	166
800408	KF 161	163
801267	KF 471	173
801342	KV 163	163
801354	KF 203	164
801360	KF 465	172
801362	KF 168	163
801364	KF 270	166
801376	KF 165	163
801382	KF 161	163
801402	KA 056	159
801428	KF 094	161
801438	KA 003	158
801450	KF 468	173
801500	KF 264	166
801538	KA 213	164
801543	KF 159	163
801554	KA 004	158
801618	KA 349	169
801644	KA 169	163
801656	KA 024	158
801698	KA 057	159
801730	KF 167	163
801750	KA 169	163
801836	KF 346	169
801836	KF 461	172
801838	KF 437	172
801838	KF 510	174
801880	KF 281	167
801950	KF 288	167
801961	KV 398	170
801970	KV 411	171

COMPETITOR	Fersa	PG.
OPTIMAL		
801972	KF 536	175
801974	KF 373	170
802265	KV 523	174
802302	KV 474	173
802315	KV 237	165
802318	KV 162	163
802324	KV 162	163
802330	KV 164	163
802378	KV 218	165
802394	KV 204	164
802444	KV 544	175
802454	KC 205	164
802464	KA 210	164
802480	KC 253	166
802485	KV 547	175
802542	KF 092	160
802590	KC 477	173
802612	KV 447	172
802652	KA 001	158
802732	KA 054	159
802748	KA 170	163
802839	KV 251	166
802870	KV 377	170
802888	KV 534	174
802980	KV 409	171
880419	KA 052	159
880421	KA 053	159
880812	KA 050	159
880912	KF 441	172
881237	KF 452	172
881489	KA 533	174
881592	KA 254	166
881704	KF 099	161
881725	KF 101	161
882483	KV 505	174
882487	KV 457	172
882491	KA 517	174
882896	KV 449	172
891311	KV 506	174
891477	KF 302	167
891484	KF 175	163
891486	KF 176	163
891544	KV 514	174
891628	KV 245	165
891628	KV 271	166
891630	KF 504	174

COMPETITOR	Fersa	PG.
891731	KF 516	174
891822	KA 068	160
891869	KV 249	166
891878	KV 467	172
891887	KF 433	171
892458	KA 212	164
892460	KA 211	164
892470	KV 177	163
892472	KV 178	163
892587	KV 401	170
892735	KV 234	165
892843	KV 242	165
892872	KV 478	173
892929	KV 480	173
911377	KF 304	168
911383	KF 102	161
911385	KV 229	165
911600	KF 320	168
911802	KF 426	171
912122	KV 501	174
912527	KF 525	174
912530	KV 100	161
912532	KV 260	166
920752	KA 086	160
921215	KF 508	174
921555	KA 397	170
921895	KF 487	173
921906	KF 388	170
922181	KV 521	174
922219	KV 336	168
922441	KA 545	175
922488	KV 438	172
922488	KV 526	174
922489	KV 485	173
922697	KV 513	174
922781	KV 230	165
922783	KV 231	165
922787	KV 489	173
922921	KV 412	171
940371	KF 225	165
941237	KF 540	175
941636	KA 214	165
941700	KF 227	165
941874	KA 393	170
941941	KB 365	169
942566	KA 389	170
942569	KV 226	165

14.3 \ Cross part number

Cruces de referencias

COMPETITOR	Fersa	PG.
OPTIMAL		
942770	KA 542	175
942773	KV 232	165
942942	KA 407	171
951409	KF 119	161
951604	KF 121	161
951606	KA 022	158
951708	KA 023	158
951722	KA 190	164
952405	KV 120	161
952415	KV 122	162
952417	KV 123	162
952593	KC 188	164
952608	KV 228	165
952661	KA 186	164
952710	KA 187	164
952769	KB 491	173
952936	KA 423	171
960578	KF 129	162
960638	KF 128	162
961229	KF 381	170
961411	KA 430	171
961479	KF 321	168
961503	KA 036	159
961648	KF 130	162
961753	KB 318	168
961801	KA 392	170
961904	KA 035	159
962435	KA 266	166
962548	KV 267	166
962682	KA 034	159
962684	KC 132	162
962703	KV 503	174
962712	KV 530	174
962718	KB 217	165
962776	KA 077	160
962905	KA 268	166
971391	KF 133	162
971391	KF 376	170
971393	KF 134	162
971393	KF 448	172
971451	KA 061	159
971455	KC 223	165
971575	KF 301	167
971612	KB 062	160
971612	KB 496	173

COMPETITOR	Fersa	PG.
971707	KB 443	172
971723	KF 509	174
971767	KV 541	175
971917	KA 405	171
971940	KF 428	171
972389	KA 007	158
972453	KC 224	165
972571	KC 265	166
972571	KC 522	174
972573	KC 444	172
972688	KC 419	171
972709	KB 416	171
972918	KA 413	171
981199	KF 370	170
981407	KF 466	172
981475	KF 309	168
981475	KF 316	168
981535	KA 002	158
981572	KF 456	172
981616	KF 259	166
981704	KV 528	174
981790	KA 065	160
981799	KF 311	168
981814	KA 066	160
981814	KA 067	160
981851	KF 310	168
981856	KF 298	167
981868	KF 197	164
981938	KF 429	171
982195	KV 482	173
982685	KC 174	163
982766	KF 173	163
982780	KF 352	169
982857	KV 537	175
982939	KV 353	169
982948	KV 451	172
991863	KV 363	169
991898	KV 439	172
991902	KV 490	173

QH		
QWB 1000	KF 240	165
QWB 1001	KV 236	165
QWB 1002	KF 304	168
QWB 1003	KF 102	161

COMPETITOR	Fersa	PG.
QH		
QWB 1005	KA 272	166
QWB 1039	KV 245	165
QWB 1039	KV 271	166
QWB 1049	KV 114	161
QWB 1052	KV 537	175
QWB 1055	KV 194	164
QWB 1057	KF 127	162
QWB 1068	KF 450	172
QWB 1069	KB 345	169
QWB 1070	KA 189	164
QWB 1071	KV 547	175
QWB 1076	KV 336	168
QWB 1079	KV 231	165
QWB 1081	KV 230	165
QWB 1084	KF 155	163
QWB 1085	KB 278	167
QWB 1086	KB 402	170
QWB 1088	KB 193	164
QWB 1089	KF 184	163
QWB 1096	KF 277	167
QWB 1098	KF 288	167
QWB 1099	KV 411	171
QWB 1101	KV 251	166
QWB 1102	KF 346	169
QWB 1103	KF 536	175
QWB 1106	KF 452	172
QWB 1109	KV 492	173
QWB 1112	KV 196	164
QWB 1113	KV 198	164
QWB 1114	KV 199	164
QWB 1115	KV 279	167
QWB 1116	KF 441	172
QWB 1117	KV 247	166
QWB 1118	KF 264	166
QWB 1124	KV 457	172
QWB 1126	KF 201	164
QWB 1127	KF 282	167
QWB 1128	KB 191	164
QWB 1131	KV 246	166
QWB 1132	KV 440	172
QWB 1133	KV 157	163
QWB 1136	KV 530	174
QWB 1137	KV 276	167
QWB 113C	KA 014	158
QWB 1142	KF 316	168
QWB 1146	KF 241	165

COMPETITOR	Fersa	PG.
QWB 114C	KA 499	173
QWB 1150	KF 145	162
QWB 1152	KV 275	167
QWB 1154	KF 308	168
QWB 1155	KA 248	166
QWB 115C	KA 017	158
QWB 1160	KV 286	167
QWB 1179	KB 422	171
QWB 1189	KV 221	165
QWB 1193	KV 532	174
QWB 1194	KF 348	169
QWB 1195	KF 280	167
QWB 1196	KA 273	166
QWB 1197	KA 033	159
QWB 1198	KA 515	174
QWB 1199	KA 032	159
QWB 1200	KV 238	165
QWB 1202	KV 234	165
QWB 1211	KF 292	167
QWB 1212	KB 338	169
QWB 1222	KF 470	173
QWB 1223	KF 303	167
QWB 1228	KV 290	167
QWB 1231	KF 302	167
QWB 1233	KV 242	165
QWB 1234	KV 178	163
QWB 1236	KV 328	168
QWB 1237	KV 460	172
QWB 1240	KV 177	163
QWB 1241	KV 249	166
QWB 1242	KV 472	173
QWB 1251	KF 340	169
QWB 1252	KF 315	168
QWB 1253	KB 339	169
QWB 1254	KF 351	169
QWB 1257	KV 284	167
QWB 1258	KV 291	167
QWB 1259	KV 325	168
QWB 1260	KV 326	168
QWB 1261	KF 329	168
QWB 1263	KF 375	170
QWB 1264	KF 371	170
QWB 1265	KF 289	167
QWB 1266	KV 445	172
QWB 1270	KV 395	170
QWB 1273	KV 294	167
QWB 1274	KB 078	160

14.3 \ Cross part number

Cruces de referencias

COMPETITOR	Fersa	PG.
QH		
QWB 1275	KV 459	172
QWB 1276	KV 305	168
QWB 1277	KV 535	175
QWB 1280	KF 525	174
QWB 1282	KF 433	171
QWB 1282	KF 504	174
QWB 1283	KV 420	171
QWB 1284	KF 176	163
QWB 1285	KA 405	171
QWB 1286	KA 413	171
QWB 1287	KV 377	170
QWB 1305	KV 484	173
QWB 1358	KV 507	174
QWB 1368	KV 322	168
QWB 159C	KA 254	166
QWB 177C	KC 253	166
QWB 194C	KD 117	161
QWB 194C	KD 118	161
QWB 200	KF 180	163
QWB 201	KA 069	160
QWB 212	KA 002	158
QWB 224	KA 059	159
QWB 224	KA 063	160
QWB 227	KF 500	174
QWB 231	KF 172	163
QWB 239	KA 055	159
QWB 241	KA 210	164
QWB 242	KA 056	159
QWB 249	KA 213	164
QWB 254	KC 205	164
QWB 255	KA 027	158
QWB 256	KA 025	158
QWB 259	KA 026	158
QWB 285	KA 040	159
QWB 286	KC 147	162
QWB 289	KA 041	159
QWB 301	KA 042	159
QWB 302	KC 146	162
QWB 302	KC 148	162
QWB 309	KF 150	162
QWB 310	KA 044	159
QWB 313	KC 149	162
QWB 328	KF 179	163
QWB 342	KA 068	160
QWB 347	KA 036	159
QWB 354	KC 132	162

COMPETITOR	Fersa	PG.
QWB 356	KC 488	173
QWB 360	KC 174	163
QWB 365	KA 066	160
QWB 365	KA 067	160
QWB 366	KA 065	160
QWB 376	KC 188	164
QWB 407	KA 071	160
QWB 411	KA 051	159
QWB 414	KA 075	160
QWB 414	KA 083	160
QWB 417	KF 133	162
QWB 418	KA 019	158
QWB 419	KA 050	159
QWB 420	KA 015	158
QWB 422	KF 160	163
QWB 422	KF 161	163
QWB 422	KF 203	164
QWB 422	KV 162	163
QWB 429	KA 005	158
QWB 430	KB 048	159
QWB 430	KB 192	164
QWB 436	KF 134	162
QWB 443	KA 003	158
QWB 445	KA 089	160
QWB 455	KF 354	169
QWB 457	KA 211	164
QWB 459	KA 073	160
QWB 461	KF 141	162
QWB 467	KV 152	162
QWB 474	KA 255	166
QWB 475	KA 476	173
QWB 479	KF 153	162
QWB 481	KA 009	158
QWB 482	KB 012	158
QWB 486	KB 011	158
QWB 490	KF 320	168
QWB 493	KA 349	169
QWB 494	KC 256	166
QWB 496	KA 072	160
QWB 497	KA 091	160
QWB 498	KF 314	168
QWB 500	KV 144	162
QWB 503	KB 008	158
QWB 508	KA 030	159
QWB 509	KV 204	164
QWB 510	KF 095	161
QWB 510	KF 185	163

COMPETITOR	Fersa	PG.
QH		
QWB 513	KF 396	170
QWB 514	KF 107	161
QWB 515	KV 163	163
QWB 521	KA 455	172
QWB 527	KA 076	160
QWB 528	KA 082	160
QWB 532	KA 347	169
QWB 533	KA 257	166
QWB 534	KV 105	161
QWB 539	KA 034	159
QWB 545	KA 010	158
QWB 556	KA 077	160
QWB 560	KB 047	159
QWB 566	KB 046	159
QWB 568	KA 081	160
QWB 569	KA 018	158
QWB 570	KF 136	162
QWB 596	KA 039	159
QWB 599	KA 212	164
QWB 602	KA 389	170
QWB 603	KV 135	162
QWB 605	KA 001	158
QWB 608	KA 049	159
QWB 629	KA 043	159
QWB 634	KF 111	161
QWB 635	KF 112	161
QWB 654	KA 028	158
QWB 659	KA 029	158
QWB 662	KB 090	160
QWB 666	KA 169	163
QWB 671	KF 092	160
QWB 678	KV 215	165
QWB 682	KF 468	173
QWB 685	KA 170	163
QWB 687	KV 156	163
QWB 691	KA 004	158
QWB 692	KA 023	158
QWB 696	KA 020	158
QWB 697	KA 021	158
QWB 698	KF 182	163
QWB 699	KA 542	175
QWB 703	KF 173	163
QWB 704	KF 352	169
QWB 707	KA 054	159
QWB 712	KF 099	161
QWB 716	KA 190	164

COMPETITOR	Fersa	PG.
QWB 722	KA 214	165
QWB 725	KA 024	158
QWB 734	KV 218	165
QWB 735	KF 465	172
QWB 736	KV 164	163
QWB 740	KA 058	159
QWB 742	KV 260	166
QWB 747	KA 186	164
QWB 754	KB 125	162
QWB 756	KA 084	160
QWB 759	KF 175	163
QWB 763	KB 217	165
QWB 766	KF 259	166
QWB 766	KF 456	172
QWB 773	KA 087	160
QWB 779	KF 106	161
QWB 781	KF 143	162
QWB 783	KF 124	162
QWB 785	KC 419	171
QWB 786	KV 108	161
QWB 786	KV 297	167
QWB 787	KF 109	161
QWB 790	KF 543	175
QWB 798	KF 142	162
QWB 803	KA 187	164
QWB 812	KB 062	160
QWB 813	KA 126	162
QWB 817	KF 115	161
QWB 817	KF 327	168
QWB 822	KC 477	173
QWB 828	KA 079	160
QWB 830	KV 219	165
QWB 831	KF 110	161
QWB 842	KA 086	160
QWB 844	KV 544	175
QWB 846	KF 261	166
QWB 850	KV 100	161
QWB 853	KF 166	163
QWB 854	KF 270	166
QWB 855	KF 165	163
QWB 855	KF 168	163
QWB 859	KF 116	161
QWB 860	KV 220	165
QWB 861	KV 222	165
QWB 863	KA 085	160
QWB 864	KF 453	172
QWB 865	KB 263	166

14.3 \ Cross part number

Cruces de referencias

COMPETITOR	Fersa	PG.
QH		
QWB 871	KF 195	164
QWB 876	KV 235	165
QWB 877	KV 202	164
QWB 878	KF 138	162
QWB 879	KV 252	166
QWB 880	KF 183	163
QWB 890	KF 227	165
QWB 891	KV 226	165
QWB 896	KC 223	165
QWB 904	KC 444	172
QWB 906	KF 104	161
QWB 915	KA 061	159
QWB 926	KV 228	165
QWB 928	KF 130	162
QWB 931	KF 129	162
QWB 933	KV 503	174
QWB 935	KF 137	162
QWB 939	KV 267	166
QWB 941	KF 321	168
QWB 942	KA 269	166
QWB 944	KF 094	161
QWB 951	KV 244	165
QWB 952	KV 243	165
QWB 954	KV 546	175
QWB 956	KF 128	162
QWB 958	KF 121	161
QWB 959	KF 301	167
QWB 963	KA 404	171
QWB 965	KV 229	165
QWB 974	KF 113	161
QWB 978	KV 514	174
QWB 993	KA 502	174
QWB 994	KF 101	161
QWB 995	KA 080	160
QWB 996	KA 013	158
QWB 997	KF 233	165
QWB 998	KV 505	174

RHP		
15 / W65	F 15211	106
RJ 2022	F 19024	118
RJ 2023	F 19055	120

RUVILLE		
4001	KB 344	169

COMPETITOR	Fersa	PG.
4001	KB 402	170
4002	KB 011	158
4003	KB 012	158
4006	KB 278	167
4006	KB 293	167
4013	KB 356	169
4014	KB 362	169
4017	KB 295	167
4017	KB 390	170
4023	KA 255	166
4024	KA 476	173
4025	KA 091	160
4026	KA 070	160
4027	KC 488	173
4033	F 15302	54
4034	KA 023	158
4037	KB 424	171
4038	KB 296	167
4038	KB 372	170
4042	KA 009	158
4043	KA 010	158
4045	KF 314	168
4052	KD 117	161
4056	KA 049	159
4058	KA 169	163
4059	KA 169	163
4065	KA 170	163
4070	KD 118	161
4072	KA 033	159
4073	KA 032	159
4076	KA 273	166
4077	KA 079	160
4078	KA 058	159
4080	KA 084	160
4081	KA 269	166
4083	KA 200	164
4085	KB 263	166
4086	KF 453	172
4087	KA 085	160
4088	KA 515	174
4089	KC 174	163
4091	KA 266	166
4094	KA 272	166
4095	KA 013	158
4096	KA 080	160
4099	KF 315	168

COMPETITOR	Fersa	PG.
RUVILLE		
5010	KF 396	170
5012	KF 107	161
5015	KV 105	161
5016	KF 104	161
5017	KV 105	161
5019	KF 106	161
5022	KV 108	161
5022	KV 297	167
5023	KF 109	161
5024	KF 110	161
5025	KF 348	169
5026	KV 532	174
5027	KF 274	166
5028	KF 470	173
5029	KV 239	165
5030	KV 238	165
5031	KF 303	167
5032	KV 472	173
5033	KF 378	170
5037	KV 431	171
5040	KV 432	171
5041	KF 418	171
5102	KA 025	158
5103	KA 026	158
5105	KA 027	158
5107	KF 124	162
5108	KA 030	159
5110	KA 126	162
5111	KA 087	160
5112	KA 029	158
5114	KA 028	158
5115	KB 125	162
5118	KA 189	164
5126	KF 280	167
5127	KF 127	162
5128	KF 300	167
5131	KF 450	172
5132	KB 345	169
5136	KA 414	171
5138	KA 406	171
5202	KA 083	160
5205	KA 499	173
5208	KA 017	158
5212	KA 014	158
5216	KA 015	158

COMPETITOR	Fersa	PG.
5217	KA 075	160
5219	KA 019	158
5220	KA 074	160
5221	KA 018	158
5223	KF 329	168
5224	KV 328	168
5228	KA 076	160
5229	KA 081	160
5232	KA 347	169
5233	KA 257	166
5234	KA 082	160
5236	KA 020	158
5237	KA 021	158
5237	KA 383	170
5239	KF 115	161
5239	KF 327	168
5242	KF 116	161
5243	KV 220	165
5244	KV 221	165
5245	KV 222	165
5254	KF 201	164
5255	KF 282	167
5256	KB 191	164
5256	KB 384	170
5258	KV 325	168
5259	KV 326	168
5260	KV 291	167
5261	KF 549	175
5262	KV 322	168
5266	KV 324	168
5267	KV 323	168
5303	KA 040	159
5307	KA 007	158
5314	KF 133	162
5314	KF 376	170
5315	KF 134	162
5315	KF 448	172
5316	KA 039	159
5318	KV 135	162
5320	KF 136	162
5322	KV 235	165
5323	KV 202	164
5325	KF 137	162
5326	KF 138	162
5327	KV 252	166
5328	KA 404	171
5330	KV 247	166

14.3 \ Cross part number

Cruces de referencias

COMPETITOR	Fersa	PG.
RUVILLE		
5331	KV 196	164
5332	KV 198	164
5333	KV 199	164
5334	KV 279	167
5335	KF 342	169
5336	KF 341	169
5337	KB 338	169
5338	KV 337	169
5339	KF 292	167
5340	KV 343	169
5341	KV 336	168
5343	KV 335	168
5347	KV 333	168
5348	KV 332	168
5349	KV 331	168
5350	KV 330	168
5401	KF 184	163
5404	KA 069	160
5408	KC 256	166
5410	KF 421	171
5412	KF 180	163
5414	KF 179	163
5415	KF 185	163
5416	KF 095	161
5417	KA 071	160
5418	KA 072	160
5423	KF 181	163
5424	KA 455	172
5428	KF 182	163
5433	KF 233	165
5434	KF 183	163
5441	KF 240	165
5442	KF 241	165
5443	KF 098	161
5444	KV 276	167
5445	KV 284	167
5446	KB 422	171
5448	KV 194	164
5449	KF 159	163
5450	KA 248	166
5452	KV 285	167
5454	KV 358	169
5455	KV 361	169
5455	KV 367	169
5456	KV 359	169
5457	KV 425	171

COMPETITOR	Fersa	PG.
5458	KV 394	170
5466	KV 250	166
5502	KF 312	168
5503	KA 043	159
5506	KA 044	159
5507	KF 375	170
5508	KC 149	162
5509	KF 153	162
5510	KC 148	162
5511	KV 152	162
5513	KB 045	159
5513	KB 193	164
5515	KV 154	163
5515	KV 258	166
5516	KF 155	163
5517	KB 046	159
5519	KB 090	160
5521	KF 150	162
5522	KA 043	159
5524	KV 156	163
5526	KV 157	163
5527	KB 047	159
5529	KB 048	159
5529	KB 192	164
5538	KF 195	164
5542	KV 546	175
5546	KV 244	165
5547	KV 243	165
5554	KV 440	172
5556	KV 246	166
5561	KF 277	167
5566	KV 492	173
5567	KV 535	175
5569	KF 340	169
5570	KB 339	169
5572	KF 371	170
5574	KF 334	168
5575	KF 351	169
5576	KF 366	169
5577	KB 350	169
5579	KB 364	169
5580	KF 539	175
5582	KV 520	174
5600	KA 063	160
5604	KF 172	163
5705	KA 005	158
5708	KF 096	161

COMPETITOR	Fersa	PG.
RUVILLE		
5716	KF 308	168
5725	KF 479	173
5727	KV 395	170
5728	KF 519	174
5731	KV 286	167
5732	KV 287	167
5742	KV 511	174
5801	KA 056	159
5802	KA 213	164
5804	KA 210	164
5807	KF 161	163
5808	KA 057	159
5810	KV 162	163
5811	KC 253	166
5812	KF 160	163
5813	KV 163	163
5814	KV 204	164
5817	KV 162	163
5818	KF 261	166
5821	KV 218	165
5822	KV 164	163
5824	KF 465	172
5825	KF 468	173
5829	KV 544	175
5830	KF 161	163
5831	KF 165	163
5832	KF 166	163
5834	KF 270	166
5835	KF 168	163
5837	KF 167	163
5838	KV 236	165
5839	KV 237	165
5841	KF 281	167
5842	KF 288	167
5843	KF 437	172
5843	KF 510	174
5844	KF 346	169
5844	KF 461	172
5845	KF 536	175
5846	KV 251	166
5853	KV 409	171
5854	KF 373	170
5855	KF 471	173
5856	KV 523	174
5859	KV 474	173
5903	KF 140	162

COMPETITOR	Fersa	PG.
5907	KF 139	162
5908	KA 041	159
5911	KA 089	160
5912	KA 073	160
5913	KF 141	162
5914	KF 142	162
5915	KV 144	162
5917	KF 145	162
5919	KB 008	158
5922	KV 215	165
5924	KF 543	175
5929	KV 219	165
5931	KF 113	161
5933	KV 460	172
5937	KV 114	161
5938	KB 078	160
5940	KV 305	168
5942	KV 290	167
5943	KV 548	175
5944	KF 289	167
5946	KV 294	167
5947	KF 399	170
5948	KV 458	172
5949	KV 410	171
5950	KB 369	170
6002	KA 001	158
6004	KA 002	158
6006	KA 003	158
6013	KF 092	160
6015	KF 264	166
6018	KF 094	161
6019	KA 004	158
6023	KV 547	175
6025	KV 411	171
6026	KV 377	170
6027	KV 534	174
6030	KV 398	170
6052	KV 447	172
6103	KF 441	172
6109	KA 254	166
6119	KV 505	174
6122	KV 457	172
6123	KF 101	161
6126	KF 452	172
6129	KV 449	172
6250	KV 374	170
6251	KV 462	172

14.3 \ Cross part number

Cruces de referencias

COMPETITOR	Fersa	PG.
RUVILLE		
6300	KA 068	160
6415	KF 504	174
6418	KF 433	171
6503	KA 211	164
6505	KA 212	164
6510	KV 177	163
6511	KF 175	163
6515	KV 178	163
6516	KF 176	163
6517	KV 245	165
6517	KV 271	166
6518	KV 514	174
6520	KV 234	165
6522	KV 242	165
6524	KF 302	167
6525	KF 516	174
6526	KV 249	166
6527	KV 467	172
6528	KV 478	173
6530	KV 480	173
6532	KV 401	170
6600	KF 500	174
6603	KF 354	169
6607	KB 368	170
6613	KF 143	162
6614	KF 111	161
6615	KF 112	161
6626	KV 275	167
6628	KF 313	168
6630	KV 459	172
6631	KV 445	172
6632	KV 435	172
6706	KA 502	174
6804	KC 132	162
6809	KA 036	159
6810	KA 077	160
6815	KA 034	159
6818	KF 129	162
6819	KB 217	165
6824	KV 267	166
6826	KF 128	162
6827	KV 503	174
6829	KV 530	174
6830	KF 130	162
6839	KB 318	168

COMPETITOR	Fersa	PG.
6840	KF 321	168
6850	KA 035	159
6852	KA 268	166
6854	KA 430	171
6900	KV 537	175
6901	KA 065	160
6902	KA 066	160
6902	KA 067	160
6910	KF 173	163
6914	KF 352	169
6924	KF 310	168
6926	KF 466	172
6929	KF 429	171
6930	KV 353	169
6936	KF 309	168
6936	KF 316	168
6937	KF 197	164
6938	KF 298	167
6950	KF 259	166
6951	KV 482	173
6964	KF 311	168
7008	KA 389	170
7009	KA 214	165
7012	KA 542	175
7022	KF 227	165
7023	KV 226	165
7024	KV 232	165
7026	KA 393	170
7032	KF 225	165
7200	KC 205	164
7201	KA 024	158
7202	KC 477	173
7300	KA 086	160
7305	KC 188	164
7306	KA 190	164
7307	KA 186	164
7307	KA 423	171
7308	KA 022	158
7309	KA 187	164
7314	KF 121	161
7316	KV 228	165
7317	KV 122	162
7318	KV 123	162
7319	KB 491	173
7322	KF 119	161
7323	KV 120	161

COMPETITOR	Fersa	PG.
RUVILLE		
7325	KV 490	173
7412	KF 099	161
7413	KF 320	168
7414	KF 525	174
7415	KV 100	161
7416	KV 260	166
7425	KF 304	168
7428	KV 229	165
7434	KF 102	161
7701	KC 444	172
7702	KA 061	159
7705	KF 509	174
7706	KF 301	167
7708	KC 224	165
7709	KC 223	165
7711	KC 265	166
7711	KC 522	174
7712	KB 062	160
7712	KB 496	173
7713	KC 419	171
7800	KA 349	169
7803	KA 054	159
7805	KV 518	174
8000	KA 050	159
8001	KA 052	159
8002	KA 053	159
8109	KB 443	172
8110	KB 416	171
8260	KF 203	164
8261	KV 420	171
8302	KA 517	174
8303	KA 533	174
8401	KA 545	175
8402	KV 230	165
8403	KV 231	165
8411	KV 412	171
8420	KV 438	172
8420	KV 526	174
8452	KA 413	171
8453	KA 405	171
8601	KV 439	172
8604	KV 363	169
8900	KA 397	170
8909	KF 487	173

COMPETITOR	Fersa	PG.
SKF		
307438	F 15210	106
314984	F 19015	118
315824	F 19002	118
316790	F 19012	118
331075	F 15083	34
331264	F 15280	38
331933	F 15051 R	32
331974	F 15272	38
332330	F 15051 C	32
440682	F 18023	76
635245	F 19009	118
1861071	F 15089	34
2206 VF 153B	F 19025	118
239697 Q	F 15046	32
30217J2/QVB478	F 15104	34
30307XR N	F 15014	32
309726 DA	F 16019	82
309726 DA	F 16019	82
309946 AC	F 16032	84
309946 AC	F 16032	84
315070 B	F 19011	118
315070 B	F 19011	118
32008 X/ QVA621+BT1-0336/ QCL7CVA606	F 15310	42
32017 X/Q	32017 XF	10
32021X	32021 XF	10
32312 J2/Q	32312 F	11
33020/QVB091	33020 F 561694	12
33021 / QVB 401	F 15239	36
33021 / QVB 401	F 15239	36
33021/QVB401	33021 F 0266488	12
330633 C	F 15082	34
330633 C	F 15082	34
330865C / 332046AD	F 15080	34
331126 Q	F 15076	34
331305A/Q	F 15047	32
331474/Q	F 15258	36
331958 Q	F 15075	34
332532/CL7A	F 15183	34
4209 ATN9 / MT33 VB2669	F 18009	76
546268J	F 19039	120
6006/32-2RS1/VB005	6006/32 2RS/C3	65
6206 2RS1/C3	6206 2RS/C3	68
6210 ZNBR	F 18032	76
63/22 C3	63/22 C3	70

14.3 \ Cross part number

Cruces de referencias

COMPETITOR	Fersa	PG.
SKF		
BA2B 309639 BA / BAHB 311396 B	F 16036	84
BA2B 446762 B	F 16026	82
BA2B 633313 C	F 16001	82
BAF 0013 AD	F 16010	82
BAF 4104 BBX	F 16209	94
BAFB 447318 B	F 16033	84
BAH 0004 AA	F 16107	90
BAH 0011 AB	F 16054	86
BAH 0012 AD	F 16031	84
BAH 0013 D	F 16027	82
BAH 0015 E	F 16093	90
BAH 0023	F 16023	82
BAH 0028 AA	F 16088	90
BAH 0031	F 16002	82
BAH 0031 D	F 16002	82
BAH 0041 D	F 16034	84
BAH 0042	F 16200	92
BAH 0049	F 16089	90
BAH 0049 C	F 16040	86
BAH 0051 B	F 16029	82
BAH 0069	F 16203	94
BAH 0094	F 16030	84
BAH 0106 D	F 16110	90
BAH 0117	F 16207	94
BAH 0164	F 16204	94
BAH 0171	F 16048	86
BAH 0174	F 16056	88
BAH 0177	F 16051	86
BAH 5000 AA	F 16004	82
BAH 5001 A	F 16022	82
BAHB 309796A	F 16195	92
BAHB 311315 BD	F 16035	84
BAHB 311316 B	F 16018	82
BAHB 311424 B	F 16045	86
BAHB 311443 B	F 16039	84
BAHB 633528	F 16002	82
BAHB 633815 AA	F 16038	84
BAHB 633966 BB	F 16055	86
BAHB 636096 A	F 16037	84
BAHB 636114 A	F 16020	82
BAHB 636149 BC/ BAHB 636149 D	F 16059	88
BAHB 636187 A	F 16090	90
BAHB 636193 C	F 16057	88
BAHB 636214 A	F 16118	92
BB1 3076	F 18053	78

COMPETITOR	Fersa	PG.
BB1 3339 CB	F 18067	78
BB1 3346	F 18059	78
BB1 3356	F 18056	78
BB1 3357	F 18054	78
BB1 3359	F 18055	78
BB1-3339CB	F 18067	78
BB1B 445924 C	F 18043	76
BB1B 630374 / C4	F 18011	76
BC1 0058	F 19070	122
BC1 0125	F 19071	122
BC1B 242820 CM	F 19105	124
BC1B 246037 A	F 19065	120
BC1B 246747	F 19014	118
BC1B 312219	F 19039	120
BC1B 319546C / VB017	F 19064	120
BC1B 319552	F 19008	118
BC1B 320297 C	F 19035	120
BC1B 320308 A	F 19063	120
BC1B 322172 A	F 19047	120
BC1B 322201 B	F 19033	120
BC1B 322467	F 19046	120
BC1B 322722	F 19081	122
BC1B 326120/HB1	F 19089	122
BC1B 635251	F 19029	118
BCAB 326332B	F 15028	32
BT1 0097 C	F 15117	34
BT1 0163	F 15252	36
BT1 0779	F 15279	38
BT1-0222 A/ QVA621+32007 X/ QCL7CVA606	F 15309	38
BT1-0227/ QVA621+L44610/ QVA621	F 15308	38
BT1-0445	CONE F 15356	48
BT1-0548A	32024 XF	10
BT1B 243150 / QCL7C	F 15071	32
BT1B 328227 CA/Q	F 15040	32
BT1B 328274A	F 15361	40
BT1B 328406 A / 30314 / QVB01	F 15119	34
BT1B 329012	F 15116	34
BT1B 329013 A/Q	F 15029	32
BT1B 329154/Q/CL7C	CONE F 15213	48
BT1B 332541 AB/Q	F 15036	32
BT1B 332600	F 15159	34
BT1B 639416 A/Q	F 15115	34
BT1B 639425	F 15184	34
BT1B332532/CL7A	F 15183	34

COMPETITOR	Fersa	PG.
SKF		
BT2-0130A	F 200004	138
BT2B 445539 CC	F 15041	52
BT2B 445539BA / VC025	F 15041	52
BTF 0021 A	F 300005	142
BTF 0110	F 300005	142
BTF 0110 / VKBA 5377 / BTF 0021 A	F 300005	142
BTF 1125 B	F 15154	52
BTFB 328755 D	F 300006	142
BTH 0018 A	F 15097	136
BTH 0018 A / VKBA 5314	F 15097	136
BTH 0022	F 15100	136
BTH 0022 / BTH 0055 / VKBA 5412	F 15100	136
BTH 0053	F 15122	136
BTH 0053 / VKBA 5397	F 15122	136
BTH 0055	F 15100	136
BTH 0075	F 15300	136
BTH 1011	F 15121	136
BTH 1011 / VKBA 3552	F 15121	136
BTH 1024	F 15187	54
BTH 1206 AB	F 15067	52
BTH 1219 AB	F 15302	54
BTH-0001	F 15317	54
BTH-0010 D	F 15125	136
BTHB 329129 ABC	F 15168	54
FW183	F 16019	82
N 2210 W	F 19026	118
NJ 308 VH.NR.C4	F 19006	118
NJ 309 VHNRC4	F 19002	118
NJG 2309 VH/C3 VB027	F 19080	122
NJG 2309 VHNR/C3	F 19001	118
NUPK 2205 S1 NR	F 19023	118
NUPK 2205 S13	F 19004	118
NUPK 309 NR.C4	F 19003	118
RBT1B 328915	CONE F 15150 A	48
VKBA 1301	KV 135	162
VKBA 1310	KA 034	159
VKBA 1315	KF 175	163
VKBA 1317	KF 104	161
VKBA 1318	KF 107	161
VKBA 1319	KF 396	170
VKBA 1320	KF 106	161
VKBA 1322	KA 542	175
VKBA 1324	KA 024	158

COMPETITOR	Fersa	PG.
VKBA 1325	KC 477	173
VKBA 1326	KF 136	162
VKBA 1327	KF 111	161
VKBA 1328	KF 112	161
VKBA 1331	KV 215	165
VKBA 1333	KA 021	158
VKBA 1337	KA 029	158
VKBA 1340	KF 259	166
VKBA 1341	KF 456	172
VKBA 1344	KF 173	163
VKBA 1346	KF 352	169
VKBA 1347	KB 125	162
VKBA 1355	KF 096	161
VKBA 1356	KF 098	161
VKBA 1356	KF 306	168
VKBA 1358	KF 182	163
VKBA 1362	KF 129	162
VKBA 1363	KB 217	165
VKBA 1366	KA 022	158
VKBA 1367	KA 187	164
VKBA 1369	KA 023	158
VKBA 1371	KC 188	164
VKBA 1374	KF 099	161
VKBA 1375	KV 260	166
VKBA 1377	KF 320	168
VKBA 1379	KV 100	161
VKBA 1385	KA 169	163
VKBA 1386	KA 169	163
VKBA 1387	KA 171	163
VKBA 1393	KA 170	163
VKBA 1396	KA 087	160
VKBA 1400	KA 502	174
VKBA 1401	KF 468	173
VKBA 1402	KF 465	172
VKBA 1403	KF 261	166
VKBA 1406	KV 156	163
VKBA 1410	KF 203	164
VKBA 1412	KF 543	175
VKBA 1413	KB 048	159
VKBA 1430	KA 054	159
VKBA 1431	KA 020	158
VKBA 1432	KF 115	161
VKBA 1432	KF 327	168
VKBA 1436	KV 177	163
VKBA 1437	KV 178	163
VKBA 1438	KF 165	163
VKBA 1439	KF 166	163

14.3 \ Cross part number Cruces de referencias

COMPETITOR	Fersa	PG.
SKF		
VKBA 1440	KV 164	163
VKBA 1441	KV 218	165
VKBA 1442	KF 161	163
VKBA 1443	KV 544	175
VKBA 1444	KA 079	160
VKBA 1445	KA 058	159
VKBA 1446	KA 058	159
VKBA 1447	KF 094	161
VKBA 1458	KV 108	161
VKBA 1459	KF 109	161
VKBA 1460	KF 110	161
VKBA 1462	KA 200	164
VKBA 1463	KA 200	164
VKBA 1465	KA 085	160
VKBA 1466	KF 453	172
VKBA 1467	KB 263	166
VKBA 1470	KA 126	162
VKBA 1475	KV 219	165
VKBA 1480	KF 116	161
VKBA 1481	KV 220	165
VKBA 1482	KV 221	165
VKBA 1484	KV 222	165
VKBA 1487	KA 003	158
VKBA 1488	KF 264	166
VKBA 1491	KF 183	163
VKBA 1494	KV 157	163
VKBA 1495	KF 176	163
VKBA 1498	KA 189	164
VKBA 1643	KV 439	172
VKBA 1915	KA 190	164
VKBA 1928	KA 393	170
VKBA 1930	KC 223	165
VKBA 1931	KC 224	165
VKBA 1933	KF 301	167
VKBA 1948	KF 225	165
VKBA 1949	KV 226	165
VKBA 1950	KF 227	165
VKBA 1953	KA 131	162
VKBA 1956	KA 186	164
VKBA 1964	KA 067	160
VKBA 1965	KA 067	160
VKBA 1966	KC 174	163
VKBA 1970	KF 121	161
VKBA 1971	KC 265	166
VKBA 1972	KC 444	172
VKBA 1978	KA 061	159

COMPETITOR	Fersa	PG.
VKBA 1985	KA 404	171
VKBA 1992	KA 545	175
VKBA 1999	KF 128	162
VKBA 310	KV 204	164
VKBA 3201	KF 130	162
VKBA 3202	KV 530	174
VKBA 3205	KA 392	170
VKBA 3206	KA 266	166
VKBA 3216	KF 310	168
VKBA 3218	KV 228	165
VKBA 3219	KB 062	160
VKBA 3220	KC 419	171
VKBA 3222	KV 503	174
VKBA 3225	KV 267	166
VKBA 3234	KV 451	172
VKBA 3235	KB 443	172
VKBA 3236	KB 416	171
VKBA 3237	KF 316	168
VKBA 3245	KF 304	168
VKBA 3246	KF 102	161
VKBA 3250	KV 229	165
VKBA 3255	KA 007	158
VKBA 3256	KF 133	162
VKBA 3257	KF 134	162
VKBA 3266	KV 230	165
VKBA 3267	KV 231	165
VKBA 3269	KV 531	174
VKBA 3271	KV 513	174
VKBA 3272	KF 381	170
VKBA 3279	KV 489	173
VKBA 3284	KA 397	170
VKBA 3298	KV 232	165
VKBA 3305	KV 120	161
VKBA 3307	KV 490	173
VKBA 3308	KF 466	172
VKBA 3309	KF 119	161
VKBA 3311	KB 318	168
VKBA 3319	KA 035	159
VKBA 3321	KA 268	166
VKBA 3325	KB 491	173
VKBA 3326	KV 122	162
VKBA 3327	KV 123	162
VKBA 3331	KA 430	171
VKBA 3401	KV 514	174
VKBA 3403	KF 137	162
VKBA 3404	KA 033	159
VKBA 3405	KA 032	159

COMPETITOR	Fersa	PG.
SKF		
VKBA 3406	KF 233	165
VKBA 3407	KA 269	166
VKBA 3408	KF 158	163
VKBA 3409	KV 202	164
VKBA 3410	KF 138	162
VKBA 3412	KF 504	174
VKBA 3413	KF 270	166
VKBA 3414	KF 168	163
VKBA 3415	KV 271	166
VKBA 3416	KF 167	163
VKBA 3418	KV 234	165
VKBA 3420	KA 052	159
VKBA 3421	KA 053	159
VKBA 3422	KV 235	165
VKBA 3423	KF 113	161
VKBA 3424	KV 236	165
VKBA 3426	KA 515	174
VKBA 3427	KF 308	168
VKBA 3428	KA 272	166
VKBA 3429	KA 013	158
VKBA 3430	KA 080	160
VKBA 3434	KA 273	166
VKBA 3435	KB 422	171
VKBA 3440	KV 546	175
VKBA 3441	KF 159	163
VKBA 3442	KV 237	165
VKBA 3443	KF 516	174
VKBA 3444	KV 238	165
VKBA 3445	KV 239	165
VKBA 3446	KF 470	173
VKBA 3447	KF 274	166
VKBA 3449	KF 240	165
VKBA 3450	KF 241	165
VKBA 3451	KV 532	174
VKBA 3452	KF 348	169
VKBA 3455	KF 184	163
VKBA 3456	KV 194	164
VKBA 3457	KV 457	172
VKBA 3458	KV 242	165
VKBA 3459	KV 547	175
VKBA 3460	KV 505	174
VKBA 3461	KF 101	161
VKBA 3468	KV 243	165
VKBA 3469	KV 244	165
VKBA 3472	KA 533	174
VKBA 3473	KA 517	174

COMPETITOR	Fersa	PG.
VKBA 3477	KV 114	161
VKBA 3480	KV 275	167
VKBA 3486	KF 127	162
VKBA 3488	KV 245	165
VKBA 3489	KV 276	167
VKBA 3490	KF 313	168
VKBA 3491	KV 246	166
VKBA 3492	KF 277	167
VKBA 3495	KF 195	164
VKBA 3496	KB 192	164
VKBA 3497	KV 440	172
VKBA 3499	KF 303	167
VKBA 3500	KB 278	167
VKBA 3501	F 15174	54
VKBA 3501	KB 402	170
VKBA 3502	KV 411	171
VKBA 3503	KV 377	170
VKBA 3504	KF 312	168
VKBA 3510	KV 196	164
VKBA 3511	KV 198	164
VKBA 3512	KV 247	166
VKBA 3513	KV 199	164
VKBA 3514	KV 279	167
VKBA 3515	KV 279	167
VKBA 3519	KA 248	166
VKBA 3520	KF 450	172
VKBA 3521	KB 345	169
VKBA 3522	KF 280	167
VKBA 3523	KV 467	172
VKBA 3524	KV 478	173
VKBA 3525	KB 193	164
VKBA 3526	KV 249	166
VKBA 3527	KF 441	172
VKBA 3528	KF 281	167
VKBA 3530	KF 201	164
VKBA 3531	KF 282	167
VKBA 3532	KB 191	164
VKBA 3535	KF 479	173
VKBA 3536	KV 250	166
VKBA 3538	KF 346	169
VKBA 3540	KV 251	166
VKBA 3541	KV 534	174
VKBA 3542	KV 492	173
VKBA 3543	KF 433	171
VKBA 3545	KV 459	172
VKBA 3546	KV 305	168
VKBA 3548	KV 284	167

14.3 \ Cross part number

Cruces de referencias

COMPETITOR	Fersa	PG.
SKF		
VKBA 3550	KV 285	167
VKBA 3551	KB 356	169
VKBA 3552	F 15121	136
VKBA 3552	KB 362	169
VKBA 3553	F 300006	142
VKBA 3554	KF 145	162
VKBA 3555	KV 252	166
VKBA 3556	KB 078	160
VKBA 3561	KV 535	175
VKBA 3562	KV 403	171
VKBA 3567	KV 286	167
VKBA 3568	KV 518	174
VKBA 3569	KV 287	167
VKBA 3570	KV 420	171
VKBA 3571	KF 342	169
VKBA 3572	KF 341	169
VKBA 3574	KF 378	170
VKBA 3575	KF 329	168
VKBA 3576	KV 328	168
VKBA 3577	KF 288	167
VKBA 3578	KF 536	175
VKBA 3580	KV 398	170
VKBA 3581	KF 283	167
VKBA 3583	KV 409	171
VKBA 3584	KF 289	167
VKBA 3585	KV 290	167
VKBA 3587	KV 114	161
VKBA 3588	KV 291	167
VKBA 3589	KV 325	168
VKBA 3590	KV 326	168
VKBA 3592	KV 460	172
VKBA 3594	KV 445	172
VKBA 3595	KV 548	175
VKBA 3596	KF 155	163
VKBA 3598	KF 373	170
VKBA 3599	KF 471	173
VKBA 3600	KF 292	167
VKBA 3601	KB 338	169
VKBA 3602	KV 337	169
VKBA 3603	KF 452	172
VKBA 3605	KF 519	174
VKBA 3606	KV 395	170
VKBA 3607	KF 446	172
VKBA 3608	KF 375	170
VKBA 3610	KV 449	172
VKBA 3613	KB 293	167

COMPETITOR	Fersa	PG.
VKBA 3614	KB 344	169
VKBA 3615	KF 371	170
VKBA 3616	KF 315	168
VKBA 3617	KB 339	169
VKBA 3618	KF 340	169
VKBA 3619	KV 506	174
VKBA 3620	KV 343	169
VKBA 3624	KV 336	168
VKBA 3625	KF 549	175
VKBA 3627	KV 401	170
VKBA 3628	KF 300	167
VKBA 3632	KV 480	173
VKBA 3635	KV 294	167
VKBA 3637	KF 351	169
VKBA 3638	KF 366	169
VKBA 3639	KB 350	169
VKBA 3640	KB 295	167
VKBA 3641	KB 296	167
VKBA 3642	KB 424	171
VKBA 3643	KV 359	169
VKBA 3644	KV 367	169
VKBA 3645	KF 421	171
VKBA 3646	KV 394	170
VKBA 3647	KF 302	167
VKBA 3648	KF 334	168
VKBA 3650	KV 333	168
VKBA 3651	KV 332	168
VKBA 3652	KV 330	168
VKBA 3653	KV 331	168
VKBA 3654	KV 323	168
VKBA 3655	KV 324	168
VKBA 3656	KV 358	169
VKBA 3657	KF 354	169
VKBA 3658	KB 368	170
VKBA 3659	KV 435	172
VKBA 3660	KV 322	168
VKBA 3661	KV 386	170
VKBA 3662	KB 436	172
VKBA 3664	KB 469	173
VKBA 3665	KV 105	161
VKBA 3666	KA 383	170
VKBA 3667	KV 297	167
VKBA 3668	KF 348	169
VKBA 3670	KV 431	171
VKBA 3673	KV 462	172
VKBA 3674	KV 374	170
VKBA 3675	KV 472	173

COMPETITOR	Fersa	PG.
SKF		
VKBA 3676	KB 364	169
VKBA 3677	KV 520	174
VKBA 3680	KB 357	169
VKBA 3681	KV 432	171
VKBA 3682	KF 418	171
VKBA 3683	KF 399	170
VKBA 3685	KV 408	171
VKBA 3688	KF 494	173
VKBA 3689	KB 390	170
VKBA 3690	KB 372	170
VKBA 3691	KV 447	172
VKBA 3693	KV 410	171
VKBA 3697	KV 507	174
VKBA 3703	KF 321	168
VKBA 3729	KF 298	167
VKBA 3730	KF 197	164
VKBA 3731	KV 537	175
VKBA 3775	KA 423	171
VKBA 3780	KF 227	165
VKBA 3785	KF 448	172
VKBA 3786	KF 376	170
VKBA 3789	KV 481	173
VKBA 3792	KA 415	171
VKBA 3794	KV 412	171
VKBA 3796	KA 413	171
VKBA 3799	KF 495	173
VKBA 3901	KA 405	171
VKBA 3902	KF 428	171
VKBA 3907	KF 299	167
VKBA 3909	F 16207	94
VKBA 3909	KF 508	174
VKBA 3922	KB 496	173
VKBA 3923	KC 463	172
VKBA 3929	KF 429	171
VKBA 3930	KV 353	169
VKBA 3931	KV 482	173
VKBA 3934	KV 521	174
VKBA 3935	KB 365	169
VKBA 3936	KA 407	171
VKBA 3945	KF 309	168
VKBA 3951	KF 426	171
VKBA 3959	KF 498	173
VKBA 3965	KF 509	174
VKBA 3969	KF 417	171
VKBA 3970	KC 522	174
VKBA 3973	KV 538	175

COMPETITOR	Fersa	PG.
VKBA 3979	KF 370	170
VKBA 3981	KF 380	170
VKBA 3991	KF 351	169
VKBA 3995	KB 400	170
VKBA 3997	KF 442	172
VKBA 502	KA 068	160
VKBA 504	KA 014	158
VKBA 505	KA 017	158
VKBA 506	KA 040	159
VKBA 513	KA 002	158
VKBA 517	KA 025	158
VKBA 523	KA 083	160
VKBA 526	KA 039	159
VKBA 527	KA 066	160
VKBA 528	KA 075	160
VKBA 529	KA 069	160
VKBA 5314	F 15097	136
VKBA 532	KA 001	158
VKBA 534	KA 065	160
VKBA 5343	JF 7049/JF 7010	19
VKBA 5377	F 300005	142
VKBA 539	KA 499	173
VKBA 5397	F 15122	136
VKBA 540	KA 041	159
VKBA 5408	F 200004	138
VKBA 5409	F 15126	136
VKBA 5412	F 15100	136
VKBA 5415	F 15125	136
VKBA 5416	F 200005	138
VKBA 5418	F 15127	136
VKBA 5419	F 15300	136
VKBA 542	KA 005	158
VKBA 5420	F 300003	142
VKBA 5423	F 200014	138
VKBA 5424	F 200015	138
VKBA 5425	F 200013	138
VKBA 543	KA 074	160
VKBA 546	KA 089	160
VKBA 547	KA 088	160
VKBA 548	KA 043	159
VKBA 551	KA 063	160
VKBA 552	KA 063	160
VKBA 5549	F 300001	142
VKBA 559	KF 161	163
VKBA 562	KA 210	164
VKBA 564	KA 042	159
VKBA 571	KA 211	164

14.3 \ Cross part number

Cruces de referencias

COMPETITOR	Fersa	PG.
SKF		
VKBA 575	KF 095	161
VKBA 576	KF 185	163
VKBA 577	KF 180	163
VKBA 593	KF 179	163
VKBA 596	KA 027	158
VKBA 607	KC 253	166
VKBA 614	KA 026	158
VKBA 618	KF 139	162
VKBA 622	KF 140	162
VKBA 625	KV 162	163
VKBA 629	KC 146	162
VKBA 636	KC 148	162
VKBA 638	KF 150	162
VKBA 639	KC 147	162
VKBA 6500	KV 458	172
VKBA 6507	KV 335	168
VKBA 6515	KB 384	170
VKBA 6516	KV 523	174
VKBA 652	KA 044	159
VKBA 6520	KF 385	170
VKBA 6521	KV 484	173
VKBA 6525	KV 387	170
VKBA 6530	KA 414	171
VKBA 6537	KA 406	171
VKBA 654	KA 043	159
VKBA 6540	KF 510	174
VKBA 6541	KV 474	173
VKBA 6543	KV 454	172
VKBA 6544	KB 369	170
VKBA 6546	KV 425	171
VKBA 6548	KV 511	174
VKBA 6549	KB 464	172
VKBA 6550	KF 461	172
VKBA 6551	KF 437	172
VKBA 6553	KV 524	174
VKBA 6556	KV 360	169
VKBA 6558	KV 361	169
VKBA 6561	KF 539	175
VKBA 6575	KF 473	173
VKBA 6623	KV 486	173
VKBA 663	KF 133	162
VKBA 6632	KF 512	174
VKBA 6643	KF 319	168
VKBA 673	KC 132	162
VKBA 675	KC 174	163
VKBA 678	KF 500	174

COMPETITOR	Fersa	PG.
VKBA 6803	KV 501	174
VKBA 6812	KF 388	170
VKBA 6814	KV 485	173
VKBA 6825	KF 525	174
VKBA 6831	KF 382	170
VKBA 6837	KV 438	172
VKBA 6838	KV 526	174
VKBA 684	KA 036	159
VKBA 685	KF 160	163
VKBA 686	KA 015	158
VKBA 687	KA 019	158
VKBA 6873	KV 527	174
VKBA 6875	KV 528	174
VKBA 6891	KF 487	173
VKBA 6913	KF 529	174
VKBA 6931	KF 475	173
VKBA 6972	KF 540	175
VKBA 6978	KV 541	175
VKBA 7005	F 15302	54
VKBA 708	KA 349	169
VKBA 713	KA 086	160
VKBA 718	KA 004	158
VKBA 723	KC 149	162
VKBA 728	KA 073	160
VKBA 729	KF 141	162
VKBA 733	KA 212	164
VKBA 734	KV 163	163
VKBA 736	KF 134	162
VKBA 738	KF 172	163
VKBA 740	KA 018	158
VKBA 741	KA 081	160
VKBA 7425	F 15324	54
VKBA 743	KV 144	162
VKBA 749	KA 254	166
VKBA 752	KA 077	160
VKBA 756	KA 030	159
VKBA 757	KF 124	162
VKBA 801	KA 072	160
VKBA 802	KA 071	160
VKBA 813	KB 011	158
VKBA 814	KB 012	158
VKBA 826	KA 070	160
VKBA 827	KC 488	173
VKBA 828	KA 476	173
VKBA 829	KA 255	166
VKBA 830	KA 091	160
VKBA 837	KA 051	159

COMPETITOR	Fersa	PG.
SKF		
VKBA 838	KA 050	159
VKBA 844	KA 009	158
VKBA 845	KA 010	158
VKBA 846	KA 010	158
VKBA 869	KB 045	159
VKBA 882	KF 142	162
VKBA 890	KV 103	161
VKBA 897	KA 076	160
VKBA 898	KA 082	160
VKBA 904	KA 389	170
VKBA 906	KF 181	163
VKBA 908	KF 314	168
VKBA 909	KF 153	162
VKBA 910	KC 256	166
VKBA 912	KA 455	172
VKBA 915	KF 143	162
VKBA 918	KA 347	169
VKBA 919	KA 257	166
VKBA 922	KD 117	161
VKBA 925	KA 056	159
VKBA 926	KA 055	159
VKBA 927	KA 213	164
VKBA 929	KA 057	159
VKBA 938	KV 105	161
VKBA 940	KV 162	163
VKBA 941	KA 028	158
VKBA 949	KA 214	165
VKBA 958	KD 118	161
VKBA 959	KA 084	160
VKBA 961	KB 008	158
VKBA 964	KF 092	160
VKBA 966	KV 152	162
VKBA 967	KV 154	163
VKBA 968	KV 258	166
VKBA 969	KB 090	160
VKBA 973	KC 205	164
VKBA 975	KB 046	159
VKBA 976	KB 047	159
VKBA 977	KA 049	159
VKBA857	F 16201	92
VKHB 2001	32308 F	11
VKHB 2002	32311 F	11
VKHB 2003	32312 F	11
VKHB 2004	32309 F	11
VKHB 2007	32306 F	11
VKHB 2013	6386/6320	19

COMPETITOR	Fersa	PG.
VKHB 2014	537/532 X	16
VKHB 2015	32209 F	10
VKHB 2016	32206 F	10
VKHB 2017	32210 F	10
VKHB 2018	32207 F	10
VKHB 2019	32211 F	10
VKHB 2020	32208 F	10
VKHB 2021	CONE JM 207049	28
VKHB 2023	JM 205149/JM 205110	28
VKHB 2024	JF 7049 A/JF 7010	19
VKHB 2026	32216 F	11
VKHB 2028	33215 F	13
VKHB 2029	HM 218248/HM 218210	28
VKHB 2030	32218 F	11
VKHB 2031	32219 F	11
VKHB 2033	32215 F	11
VKHB 2034	CONE 395 S	15
VKHB 2036	39580/39520	25
VKHB 2040	594/592 A	16
VKHB 2041	580/572	16
VKHB 2042	683/672	17
VKHB 2043	663/653	17
VKHB 2044	33014 F	12
VKHB 2046	33015 F	12
VKHB 2047	33013 F	12
VKHB 2048	33018 F	12
VKHB 2050	HM 215249/HM 215210	28
VKHB 2051	33213 F	13
VKHB 2053	HM 220149/HM 220110	28
VKHB 2054	2789/2720	17
VKHB 2055	1380/1328	17
VKHB 2056	33109 F	12
VKHB 2057	33205 F	13
VKHB 2058	32304 F	11
VKHB 2059	33111 F	12
VKHB 2060	32011 XF	10
VKHB 2061	33211 F	13
VKHB 2063	32307 F	11
VKHB 2065	33208 F	13
VKHB 2066	33214 F	13
VKHB 2067	33209 F	13
VKHB 2068	33210 F	13
VKHB 2070	32310 F	11
VKHB 2071	F 15051 C	32
VKHB 2072	32314 F	11
VKHB 2075	33895/33822	24
VKHB 2080	32217 F	11

14.3 \ Cross part number Cruces de referencias

COMPETITOR	Fersa	PG.
SKF		
VKHB 2081	32214 F	11
VKHB 2082	33019 F	12
VKHB 2083	598 A/592 A	16
VKHB 2088	39581/39520	25
VKHB 2089	3585/3525	18
VKHB 2124	33020 F	12
VKHB 2132	F 15051 R	32
VKHB 2137	JM 714249/JM 714210	29
VKHB 2140	33016 F	12
VKHB 2141	681 A/672	17
VKHB 2143	687/672	17
VKHB 2145	33020 F	12
VKHB 2145	33020 F 561694	12
VKHB 2146	33021 F	12
VKHB 2146	33021 F 0266488	12
VKHB 2147	JF 10049/JF 10010	20
VKHB 2151	LM 48548/LM 48510	26
VKHB 2152	M 12649/M 12610	20
VKHB 2153	LM 501349/LM 501310	29
VKHB 2154	32014 XF	10
VKHB 2155	33015 F	12
VKHB 2156	33011 F	12
VKHB 2157	32016 XF	10
VKHB 2158	33117 F	12
VKHB 2159	33113 F	12
VKHB 2160	32021 XF	10
VKHB 2161	32019 XF	10
VKHB 2162	33021 F	12
VKHB 2163	33022 F	12
VKHB 2164	30220 F	8
VKHB 2165	33220 F	13
VKHB 2167	30210 F	8
VKHB 2168	30215 F	8
VKHB 2169	32017 XF	10
VKHB 2170	32018 XF	10
VKHB 2171	32314 BF	11
VKHB 2172	F 15272	38
VKHB 2173	33212 F	13
VKHB 2175	39590/39520	25
VKHB 2177	33116 F	12
VKHB 2178	33118 F	12
VKHB 2179	33206 F	13
VKHB 2182	33207 F	13
VKHB 2184	JF 4549/JF 4510	19
VKHB 2186	JHM 720249/JHM 720210	30
VKHB 2188	32008 XF	10

COMPETITOR	Fersa	PG.
VKHB 2189	30205 F	8
VKHB 2190	33108 F	12
VKHB 2191	32010 XF	10
VKHB 2192	JF 9549/JF 9510	19
VKHB 2195	6379/6320	19
VKHB 2198	30311 F	9
VKHB 2199	32013 XF	10
VKHB 2200	47487/47420	25
VKHB 2201	30309 F	9
VKHB 2202	30307 F	8
VKHB 2204	30216 F	8
VKHB 2205	JM 515649/JM 515610	29
VKHB 2208	567/563	16
VKHB 2212	32221 F	11
VKHB 2214	33113 F	12
VKHB 2215	30221 F	8
VKHB 2216	32024 XF	10
VKHB 2222	33115 F	12
VKHB 2225	33217 F	13
VKHB 2226	JM 718149 A/JM 718110	30
VKHB 2227	HM 518445/HM 518410	29
VKHB 2228	JF 6049/JF 6010	19
VKHB 2232	33216 F	13
VKHB 2233	33112 F	12
VKHB 2234	32012 XF	10
VKHB 2236	32309 BF	11
VKHB 2237	L 68149/L 68110	27
VKHB 2239	18690/18620	22
VKHB 2242	CONE 3490	18
VKHB 2243	JM 511946/JM 511910	29
VKHB 2246	18790/18720	22
VKHB 2247	32924 F	12
VKHB 2248	30218 F	8
VKHB 2249	33209 F	13
VKHB 2255	JF 5049/JF 5010	19
VKHB 2262	30305 F	8
VKHB 2267	32006 XF	9
VKHB 2270	LM 11949/LM 11910	20
VKHB 2271	LM 12749/LM 12710	20
VKHB 2272	LM 300849/LM 300811	28
VKHB 2275	32010 XF	10
VKHB 2276	387 A/382	14
VKHB 2277	387 A/382 A	14
VKHB 2279	F 15115	34
VKHB 2280 / BT1 0084	F 15193	36
VKHB 2281	32022 XF	10
VKHB 2282	32015 XF	10

COMPETITOR	Fersa	PG.
SKF		
VKHB 2283	30312 F	9
VKHB 2284	32214 F	11
VKHB 2286	HM 212049/HM 212011	28
VKHB 2287	JH 211749/JH 211710	28
VKHB 2288	32213 F	11
VKHB 2294	32305 F	11
VKHB 2296	30209 F	8
VKHB 2297	32220 F	11
VKHB 2304	30313 F	9
VKHB 2306	32020 XF	10
VKHB 2307	F 15271	36
VKHB 2309	25590/25520	23
VKHB 2310	3780/3720	18
VKHB 2311	33287/33462	24
VKHB 2315	F 15252	36
VKHB 2321	33017 F	12
VKHB 2326	33116 F	12
VKHB 2329	F 15208	36
VKHB 2331	33118 F	12
VKHB 2332	H 212749/H 212710	28
VKHB 2333	495/493	15
VKHB 2334	30217 F	8
VKHB 2338	JLM 714149/JLM 714110	29
VKHB 2347	32212 F	10
VKHB 2401 S	32310 F	11
VKHB 2402 S	32924 F	12
VKHB 2403 S	33116 F	12
VKHB 2404 S	33118 F	12
VKHB 2405 S	33213 F	13
VKHB 2406 S	33215 F	13
VKHB 2407 S	HM 218248/HM 218210	28
VKHB 2408 S	HM 518445/HM 518410	29
VKHB 2409 S	32216 F	11
VKHB 2410 S	32218 F	11
VKHB 2412 S	JM 515649/JM 515610	29
VKHB 2413 S	JM 718149 A/JM 718110	30
VKT 8438	F 15239	36
VKT 8446	6017 NR	66
VKT 8490	30217 F	8
VKT 8491	CONE 33113 F	12
VKT 8600	39580/39528	25
VKT 8601	575/572 X	16
VKT 8603	33208 F	13
VKT 8611	6215 NR/C3	69
VKT 8621	F 19105	124
VKT 8622	33017 F	12

COMPETITOR	Fersa	PG.
VKT 8625	JF 5049/JF 5010	19
VKT 8627	H 913842/H 913810	31
VKT 8628	F 19080	122
VKT 8629	F 15071	32
VKT 8631	JW 7049/JW 7010	19
VKT 8633	31315 F	9
VKT 8634	32015 XF	10
VKT 8644	CONE JF 4049	19
VKT 8645	HM 911245/HM 911210	31
VKT 8647	30208 F	8
VKT 8648	33212 F	13
VKT 8652	NUP 309 FN/C3	115
VKT 8690	32212 F	10
VKT 8692	F 18053	78
VKT 8699	CONE F 15150 A	48
VKT 8700	CONE JD 6549	19
VKT 8701	F 15116	34
VKT 8707	6211 C3	68
VKT 8718	F 15119	34
VKT 8719	6312 C3	72
VKT 8720	30312 F	9
VKT 8721	JD 6549/JD 6510	19
VKT 8749	32020 XF	10
VKT 8750	H 913843/H 913810	31
VKT 8756	32017 XF	10
VKT 8757	30217 F	8
VKT 8759	31311 F	9
VKT 8761	31313 F	9
VKT 8776	F 15048	32
VKT 8779	F 19014	118
VKT 8782	F 15046	32
VKT 8783	F 19006	118
VKT 8784	F 19002	118
VKT 8796	F 19001	118
VKT 8798	33018 F	12
VKT 8806	6217 C3	69
VKT 8853	F 19070	122
VKT 8863	33115 F	12
VKT 8864	32313 BF	11
VKT 8871	32021 XF	10
VKT 8875	F 19089	122
VKT 8886	F 15047	32
VKT 8906	F 19061	120
VKT 8937	6216 C3	69
VKT 8940	6218 C3	69
VKT 8950	33021 F	12
VKT 8955	4580/4535	19

14.3 \ Cross part number

Cruces de referencias

COMPETITOR	Fersa	PG.
VKT 8956	CONE 4395	48
VKT 8957	CONE F 15213	48
VKT 8999	F 19081	122
VKT 9000	F 15345	40
VKT 9010	F 15348	40
VKT8418	JW 5049/JW 5010	19

SNR

4209 A	F 18009	76
6210NRZB	F 18032	76
AB12516	F 18022	76
AB12888 S05	F 18018	76
AB41386	F 18019	76
AP 40016	F 15052	106
AP 40277 S01	F 15224	106
EC 10059	F 15063	32
EC 12567 H206	F 15090	42
EC 12606 S01 H106	F 15341	40
EC 42192 Y S02 H206	F 15336	38
EC 42193 Y S02 H206	F 15338	40
EC 42217 S01 H206	F 15340	40
EC 42224 S01 H206	F 15337	40
EC 42226	F 15313	38
EC 42310 S01 H200	F 15339	40
EC42228S01	F 15316	38
ETR 122205	F 19045	120
FC 12025 S09	F 15041	52
FC 12033	F 15381	40
FC 12033S01	F 15044	52
FC 12180 S04	F 15042	52
FC 12271 S03	F 15043	52
FC 12784 S03	F 15050	52
FC 40096 S05	F 15174	54
FC 40650 S01	F 15128	52
FC 40858 S02	F 15175	54
FC41645	F 15360	54
GB 10790 S05	F 16001	82
GB 10800	F 16043	86
GB 10840 S04	F 16002	82
GB 10884	F 16019	82
GB 12010	F 16045	86
GB 12094 S10	F 16026	82
GB 12131 S03	F 16031	84
GB 12136	F 16023	82
GB 12163 S04	F 16048	86
GB 12306S02	F 16093	90
GB 12320S02	F 16039	84

COMPETITOR	Fersa	PG.
GB 12399S01	F 16038	84
GB 12438 S01	F 16021	82
GB 12955S04	F 16107	90
GB 35098	F 16129	92
GB 35275	F 16124	92
GB 35457	F 16088	90
GB 40246 S02	F 16056	88
GB 40250 S01	F 16066	88
GB 40279S01	F 16109	90
GB 40300	F 16121	92
GB 40547	F 16029	82
GB 40549 / GB 10702 S03	F 16051	86
GB 40575 S02	F 16123	92
GB 40706	F 16030	84
GB 41599 / GB 12776	F 16036	84
GB 41688 P	F 16076	88
HDB001	32019 XF	10
HDB002	33019 F	12
HDB003	30221 F	8
HDB004	33113 F	12
HDB005	33118 F	12
HDB006	32017 XF	10
HDB007	33022 F	12
HDB008	33021 F	12
HDB009	32310 F	11
HDB010	33215 F	13
HDB011	33211 F	13
HDB012	32216 F	11
HDB013	33020 F	12
HDB014	32314 F	11
HDB015	32311 F	11
HDB016	32024 XF	10
HDB017	30220 F	8
HDB018	33117 F	12
HDB019	32020 XF	10
HDB020	33208 F	13
HDB021	33116 F	12
HDB022	33213 F	13
HDB023	HM 218248/HM 218210	28
HDB024	HM 518445/HM 518410	29
HDB025	32308 F	11
HDB026	32312 F	11
HDB028	32309 F	11
HDB029	32306 F	11
HDB030	32209 F	10
HDB031	32206 F	10

COMPETITOR	Fersa	PG.
SNR		
HDB032	32210 F	10
HDB033	32207 F	10
HDB034	32211 F	10
HDB035	32208 F	10
HDB036	32218 F	11
HDB037	32215 F	11
HDB038	32304 F	11
HDB039	32307 F	11
HDB040	30314 F	9
HDB042	32217 F	11
HDB043	30215 F	8
HDB044	30205 F	8
HDB045	30311 F	9
HDB046	30309 F	9
HDB047	30307 F	8
HDB048	30216 F	8
HDB049	30312 F	9
HDB050	32214 F	11
HDB051	32213 F	11
HDB054	33015 F	12
HDB055	33013 F	12
HDB056	33018 F	12
HDB057	33109 F	12
HDB058	33111 F	12
HDB059	32011 XF	10
HDB060	33214 F	13
HDB061	33209 F	13
HDB062	33210 F	13
HDB063	32014 XF	10
HDB064	33011 F	12
HDB065	32016 XF	10
HDB066	32021 XF	10
HDB067	32018 XF	10
HDB068	33212 F	13
HDB069	33206 F	13
HDB070	33207 F	13
HDB071	32008 XF	10
HDB072	33108 F	12
HDB073	32010 XF	10
HDB074	33216 F	13
HDB075	32013 XF	10
HDB076	32221 F	11
HDB077	33115 F	12
HDB078	33217 F	13
HDB080	30305 F	8
HDB081	32006 XF	9

COMPETITOR	Fersa	PG.
HDB082	32206 F	10
HDB083	LM 11949/LM 11910	20
HDB084	LM 12749/LM 12710	20
HDB085	32022 XF	10
HDB086	32015 XF	10
HDB088	32305 F	11
HDB089	32220 F	11
HDB090	32219 F	11
HDB092	JM 515649/JM 515610	29
HDB138	33205 F	13
HDS001	F 300003	142
HDS103	F 15100	136
N 2206 VF 153B	F 19025	118
N 2210 W	F 19026	118
NF-12190	F 19035	120
NF12192501	F 19063	120
R 140.01	KB 344	169
R 140.02	KB 011	158
R 140.03	KB 012	158
R 140.06	KB 293	167
R 140.13	KB 356	169
R 140.14	KB 362	169
R 140.17	KB 295	167
R 140.17	KB 390	170
R 140.23	KA 255	166
R 140.24	KA 476	173
R 140.25	KA 091	160
R 140.26	KA 070	160
R 140.27	KC 488	173
R 140.34	KA 023	158
R 140.37	KB 424	171
R 140.38	KB 296	167
R 140.42	KA 009	158
R 140.43	KA 010	158
R 140.44	KA 010	158
R 140.52	KD 117	161
R 140.56	KA 049	159
R 140.58	KA 169	163
R 140.59	KA 169	163
R 140.60	KA 171	163
R 140.65	KA 170	163
R 140.72	KA 033	159
R 140.73	KA 032	159
R 140.76	KA 273	166
R 140.77	KA 079	160
R 140.78	KA 058	159
R 140.79	KA 058	159

14.3 \ Cross part number Cruces de referencias

COMPETITOR	Fersa	PG.
SNR		
R 140.80	KA 084	160
R 140.81	KA 269	166
R 140.83	KA 200	164
R 140.84	KA 200	164
R 140.85	KB 263	166
R 140.86	KF 453	172
R 140.87	KA 085	160
R 140.88	KA 515	174
R 140.91	KA 266	166
R 140.94	KA 272	166
R 140.95	KA 013	158
R 140.96	KA 080	160
R 141.03	KB 372	170
R 141.05	KF 385	170
R 141.09	KV 387	170
R 150.10	KF 396	170
R 150.12	KF 107	161
R 150.16	KF 104	161
R 150.17	KV 105	161
R 150.19	KF 106	161
R 150.22	KV 108	161
R 150.23	KF 109	161
R 150.24	KF 110	161
R 150.26	KV 532	174
R 150.27	KF 348	169
R 150.28	KF 470	173
R 150.29	KV 239	165
R 150.30	KV 238	165
R 150.31	KF 303	167
R 150.32	KV 472	173
R 150.33	KF 378	170
R 150.37	KV 431	171
R 150.40	KV 432	171
R 150.41	KF 418	171
R 150.42	KF 512	174
R 151.02	KA 025	158
R 151.03	KA 026	158
R 151.05	KA 027	158
R 151.07	KF 124	162
R 151.08	KA 030	159
R 151.10	KA 126	162
R 151.11	KA 087	160
R 151.12	KA 029	158
R 151.14	KA 028	158
R 151.15	KB 125	162
R 151.24	KA 189	164

COMPETITOR	Fersa	PG.
R 151.25	KF 300	167
R 151.26	KF 280	167
R 151.27	KF 127	162
R 151.31	KF 450	172
R 151.32	KB 345	169
R 151.365	KA 414	171
R 151.38	KA 406	171
R 152.02	KA 083	160
R 152.05	KA 499	173
R 152.08	KA 017	158
R 152.12	KA 014	158
R 152.16	KA 015	158
R 152.17	KA 075	160
R 152.19	KA 019	158
R 152.20	KA 074	160
R 152.21	KA 018	158
R 152.23	KF 329	168
R 152.24	KV 328	168
R 152.28	KA 076	160
R 152.28	KA 082	160
R 152.32	KA 347	169
R 152.33	KA 257	166
R 152.36	KA 020	158
R 152.37	KA 021	158
R 152.39	KF 115	161
R 152.39	KF 327	168
R 152.42	KF 116	161
R 152.43	KV 220	165
R 152.44	KV 221	165
R 152.45	KV 222	165
R 152.54	KF 201	164
R 152.55	KF 282	167
R 152.56	KB 191	164
R 152.56	KB 384	170
R 152.58	KV 325	168
R 152.59	KV 326	168
R 152.60	KV 291	167
R 152.61	KF 549	175
R 152.62	KV 322	168
R 152.64	KA 383	170
R 152.66	KV 323	168
R 152.66	KV 324	168
R 152.69	KV 386	170
R 152.70	KV 484	173
R 153.03	KA 040	159
R 153.07	KA 007	158
R 153.14	KF 133	162

COMPETITOR	Fersa	PG.
SNR		
R 153.15	KF 134	162
R 153.16	KA 039	159
R 153.19	KV 135	162
R 153.20	KF 136	162
R 153.22	KV 235	165
R 153.23	KV 202	164
R 153.25	KF 137	162
R 153.26	KF 138	162
R 153.27	KV 252	166
R 153.30	KV 247	166
R 153.31	KV 196	164
R 153.32	KV 198	164
R 153.33	KV 199	164
R 153.34	KV 279	167
R 153.35	KF 342	169
R 153.36	KF 341	169
R 153.37	KB 338	169
R 153.38	KV 337	169
R 153.39	KF 292	167
R 153.40	KV 343	169
R 153.41	KV 336	168
R 153.42	KA 404	171
R 153.43	KV 335	168
R 153.46	KF 319	168
R 153.47	KV 333	168
R 153.48	KV 332	168
R 153.49	KV 331	168
R 153.50	KV 330	168
R 153.51	KV 524	174
R 153.55	KF 437	172
R 153.57	KF 461	172
R 154.01	KF 184	163
R 154.08	KC 256	166
R 154.10	KF 421	171
R 154.12	KF 180	163
R 154.13	KA 069	160
R 154.14	KF 179	163
R 154.15	KF 095	161
R 154.15	KF 185	163
R 154.17	KA 071	160
R 154.18	KA 072	160
R 154.23	KF 181	163
R 154.24	KA 455	172
R 154.28	KF 182	163
R 154.33	KF 233	165
R 154.34	KF 183	163

COMPETITOR	Fersa	PG.
R 154.41	KF 240	165
R 154.42	KF 241	165
R 154.43	KF 098	161
R 154.44	KV 276	167
R 154.45	KV 284	167
R 154.46	KB 422	171
R 154.49	KF 159	163
R 154.50	KA 248	166
R 154.52	KV 285	167
R 154.54	KV 361	169
R 154.54	KV 367	169
R 154.55	KV 358	169
R 154.56	KV 359	169
R 154.56	KV 486	173
R 154.57	KV 425	171
R 154.58	KV 394	170
R 154.61	KV 360	169
R 155.00	KC 146	162
R 155.01	KC 147	162
R 155.03	KA 043	159
R 155.05	KA 042	159
R 155.06	KA 044	159
R 155.07	KF 375	170
R 155.08	KC 149	162
R 155.09	KF 153	162
R 155.10	KC 148	162
R 155.11	KV 152	162
R 155.13	KB 045	159
R 155.14	KF 314	168
R 155.15	KV 154	163
R 155.16	KF 155	163
R 155.17	KB 046	159
R 155.18	KV 258	166
R 155.19	KB 090	160
R 155.21	KF 150	162
R 155.22	KA 043	159
R 155.24	KV 156	163
R 155.26	KV 157	163
R 155.27	KB 047	159
R 155.31	KF 151	162
R 155.32	KB 048	159
R 155.32	KB 192	164
R 155.42	KV 546	175
R 155.44	KF 195	164
R 155.46	KV 244	165
R 155.47	KV 243	165
R 155.52	KF 312	168

14.3 \ Cross part number

Cruces de referencias

COMPETITOR	Fersa	PG.
SNR		
R 155.54	KV 440	172
R 155.56	KV 246	166
R 155.61	KF 277	167
R 155.63	KB 193	164
R 155.64	KB 278	167
R 155.65	KB 402	170
R 155.66	KV 492	173
R 155.67	KV 535	175
R 155.69	KF 340	169
R 155.70	KB 339	169
R 155.71	KF 315	168
R 155.72	KF 371	170
R 155.74	KF 334	168
R 155.75	KF 351	169
R 155.76	KF 366	169
R 155.77	KB 350	169
R 155.78	KB 364	169
R 155.80	KF 539	175
R 155.82	KV 520	174
R 156.00	KA 063	160
R 156.04	KF 172	163
R 157.05	KA 005	158
R 157.08	KF 096	161
R 157.16	KF 308	168
R 157.20	KV 194	164
R 157.24	KF 306	168
R 157.25	KF 479	173
R 157.26	KV 250	166
R 157.27	KV 395	170
R 157.28	KF 519	174
R 157.31	KV 286	167
R 157.32	KV 287	167
R 157.42	KV 511	174
R 157.46	KF 446	172
R 157.49	KV 518	174
R 158.00	KA 055	159
R 158.01	KA 056	159
R 158.02	KA 213	164
R 158.04	KA 210	164
R 158.07	KF 161	163
R 158.08	KA 057	159
R 158.10	KV 162	163
R 158.11	KC 253	166
R 158.13	KV 163	163
R 158.14	KV 204	164
R 158.17	KV 162	163

COMPETITOR	Fersa	PG.
R 158.18	KF 261	166
R 158.21	KV 218	165
R 158.22	KV 164	163
R 158.24	KF 465	172
R 158.25	KF 468	173
R 158.28	KF 160	163
R 158.29	KV 544	175
R 158.31	KF 165	163
R 158.32	KF 166	163
R 158.34	KF 270	166
R 158.35	KF 168	163
R 158.37	KF 167	163
R 158.39	KV 237	165
R 158.41	KF 281	167
R 158.42	KF 288	167
R 158.43	KF 510	174
R 158.44	KF 346	169
R 158.45	KF 536	175
R 158.46	KV 251	166
R 158.53	KV 409	171
R 158.54	KF 373	170
R 158.55	KF 471	173
R 158.56	KV 523	174
R 158.58	KF 283	167
R 158.59	KV 474	173
R 159.03	KF 140	162
R 159.07	KF 139	162
R 159.08	KA 041	159
R 159.11	KA 089	160
R 159.12	KA 073	160
R 159.13	KF 141	162
R 159.14	KF 142	162
R 159.15	KV 144	162
R 159.17	KF 145	162
R 159.19	KB 008	158
R 159.22	KV 215	165
R 159.24	KF 543	175
R 159.29	KV 219	165
R 159.31	KF 113	161
R 159.32	KV 236	165
R 159.37	KV 114	161
R 159.38	KB 078	160
R 159.40	KV 305	168
R 159.42	KV 290	167
R 159.43	KV 403	171
R 159.43	KV 548	175
R 159.44	KF 289	167

COMPETITOR	Fersa	PG.
SNR		
R 159.46	KV 294	167
R 159.47	KF 399	170
R 159.48	KB 357	169
R 159.49	KV 410	171
R 159.50	KV 458	172
R 159.53	KB 369	170
R 159.54	KB 464	172
R 159.55	KF 473	173
R 159.89	KB 193	164
R 160.02	KA 001	158
R 160.13	KF 092	160
R 160.15	KF 264	166
R 160.18	KF 094	161
R 160.20	KF 264	166
R 160.23	KV 547	175
R 160.25	KV 411	171
R 160.27	KV 534	174
R 160.30	KV 398	170
R 160.36	KA 002	158
R 160.38	KA 003	158
R 160.44	KA 004	158
R 160.48	KV 377	170
R 160.51	KV 447	172
R 161.03	KF 441	172
R 161.09	KA 254	166
R 161.19	KV 505	174
R 161.22	KV 457	172
R 161.23	KF 101	161
R 161.26	KF 452	172
R 161.29	KV 449	172
R 162.50	KV 374	170
R 162.51	KV 462	172
R 163.19	KA 068	160
R 164.15	KF 504	174
R 164.18	KF 433	171
R 164.25	KV 506	174
R 165.03	KA 211	164
R 165.05	KA 212	164
R 165.10	KV 177	163
R 165.11	KF 175	163
R 165.15	KV 178	163
R 165.16	KF 176	163
R 165.17	KV 271	166
R 165.18	KV 514	174
R 165.20	KV 234	165
R 165.22	KV 242	165

COMPETITOR	Fersa	PG.
R 165.23	KV 245	165
R 165.24	KF 302	167
R 165.25	KF 516	174
R 165.26	KV 249	166
R 165.27	KV 467	172
R 165.28	KV 478	173
R 165.30	KV 480	173
R 165.37	KV 454	172
R 166.00	KF 500	174
R 166.03	KF 354	169
R 166.07	KB 368	170
R 166.13	KF 143	162
R 166.14	KF 111	161
R 166.15	KF 112	161
R 166.24	KV 114	161
R 166.26	KV 275	167
R 166.28	KF 313	168
R 166.29	KV 460	172
R 166.30	KV 459	172
R 166.31	KV 445	172
R 166.32	KV 435	172
R 167.06	KA 502	174
R 168.04	KC 132	162
R 168.09	KA 036	159
R 168.10	KA 077	160
R 168.15	KA 034	159
R 168.18	KF 129	162
R 168.19	KB 217	165
R 168.24	KV 267	166
R 168.26	KF 128	162
R 168.27	KV 503	174
R 168.29	KV 530	174
R 168.30	KF 130	162
R 168.40	KF 321	168
R 168.41	KA 131	162
R 168.42	KB 318	168
R 168.50	KA 035	159
R 168.54	KA 430	171
R 168.59	KA 392	170
R 168.61	KB 400	170
R 168.62	KF 380	170
R 168.63	KF 381	170
R 168.65	KF 442	172
R 169.00	KV 537	175
R 169.01	KA 065	160
R 169.02	KA 066	160
R 169.02	KA 067	160

14.3 \ Cross part number Cruces de referencias

COMPETITOR	Fersa	PG.
SNR		
R 169.04	KC 174	163
R 169.08	KF 456	172
R 169.10	KF 173	163
R 169.14	KF 352	169
R 169.20	KV 451	172
R 169.23	KA 067	160
R 169.24	KF 310	168
R 169.26	KF 466	172
R 169.29	KF 429	171
R 169.30	KV 353	169
R 169.36	KF 316	168
R 169.37	KF 197	164
R 169.38	KF 298	167
R 169.50	KF 259	166
R 169.51	KV 482	173
R 169.59	KV 507	174
R 169.60	KF 309	168
R 169.61	KF 382	170
R 169.68	KF 370	170
R 170.08	KA 389	170
R 170.09	KA 214	165
R 170.12	KA 542	175
R 170.22	KF 227	165
R 170.23	KV 226	165
R 170.24	KV 232	165
R 170.26	KA 393	170
R 170.32	KF 225	165
R 170.49	KF 540	175
R 172.00	KC 205	164
R 172.01	KA 024	158
R 172.02	KC 477	173
R 173.00	KA 086	160
R 173.05	KC 188	164
R 173.06	KA 190	164
R 173.07	KA 186	164
R 173.09	KA 187	164
R 173.14	KF 121	161
R 173.15	KA 022	158
R 173.16	KV 228	165
R 173.17	KV 122	162
R 173.18	KV 123	162
R 173.19	KB 491	173
R 173.20	KA 423	171
R 173.22	KF 119	161
R 173.23	KV 120	161
R 173.25	KV 490	173

COMPETITOR	Fersa	PG.
R 173.31	KV 538	175
R 174.12	KF 099	161
R 174.13	KF 320	168
R 174.14	KF 525	174
R 174.16	KV 260	166
R 174.19	KV 100	161
R 174.25	KF 304	168
R 174.28	KV 229	165
R 174.34	KF 102	161
R 174.40	KF 426	171
R 177.01	KC 444	172
R 177.02	KA 061	159
R 177.06	KF 301	167
R 177.08	KC 224	165
R 177.09	KC 223	165
R 177.11	KC 265	166
R 177.12	KB 062	160
R 177.13	KC 419	171
R 177.15	KC 463	172
R 177.33	KB 496	173
R 177.37	KF 509	174
R 178.00	KA 349	169
R 178.03	KA 054	159
R 180.00	KA 050	159
R 180.01	KA 052	159
R 180.02	KA 053	159
R 181.09	KB 443	172
R 181.10	KB 416	171
R 182.60	KF 203	164
R 182.61	KV 420	171
R 183.02	KA 517	174
R 183.03	KA 533	174
R 184.01	KA 545	175
R 184.02	KV 230	165
R 184.03	KV 231	165
R 184.05	KF 299	167
R 184.07	KV 336	168
R 184.09	KV 513	174
R 184.11	KV 412	171
R 184.12	KF 508	174
R 184.13	KF 388	170
R 184.14	KF 487	173
R 184.15	KV 526	174
R 184.16	KV 438	172
R 184.24	KV 485	173
R 184.33	KA 415	171
R 184.52	KA 413	171

COMPETITOR	Fersa	PG.
SNR		
R 184.53	KA 405	171
R 184.55	KF 428	171
R 186.01	KV 439	172
R 189.00	KA 397	170
R 189.02	KV 489	173
R 189.05	KV 521	174
R 189.07	KB 365	169
R 189.08	KA 407	171
R 190.00	KF 376	170
R 190.01	KF 448	172
R 190.03	KV 531	174
TGB 10872 S02	F 16044	86
TGB 40490	F 16010	82
XGB 40492 S01 P	F 16108	90
XGB 40575 S02 P	F 16128	92
XGB 41793 S01	F 16213	94
XGB 41999	F 16052	86
XGB35270	F 16215	94
Y44FB.10394 S02	F 16042	86

TIMKEN		
14116/14276	14116/14276	20
29688/29620	29688/29620	24
32021 XF	32021 XF	10
43112/43312	43112/43312	25
44131/44348	44131/44348	25
47687/47623 A	47687/47623 A	26
72187C/72487	72187 C/72487	27
77375/77675	77375/77675	27
H715343	CONE H 715343	26
HM801346X/ HM801310	HM 801346 X/HM 801310	30
HM813844/HM813810	HM 813844/HM 813810	30
HM813849/HM813810	HM 813849/HM 813810	31
JH211749/JH211710	JH 211749/JH 211710	28
JL22349 / 10	F 15028	32
JRM 3535 A / JRM 3565 XD	F 15044	52
JRM 3939 / JRM 3968 XD	F 15045	52
JXC 19089 DA	CONE F 15134	48
JXC 25469CA / JXC 25469 DB	F 15068	52
JXC 25662 C	CONE F 15110	48
JXC 25690 C / JXC 25690 DC	F 15161	42
JXC 6839 CD	CONE F 15101	48
MB1212GEXR	F 19117	124

COMPETITOR	Fersa	PG.
MUSB1307UM	F 19083	122
NP 057427	CONE F 15132	48
NP 078914	F 15097	136
NP 086391	F 15156	34
NP 237087	CONE F 15362	48
NP 318274-90UA7	F 15122	136
NP 318274-90UA7 / SET 1242	F 15122	136
NP 353549 / NP 673396	F 15197	36
NP 374995	CONE 64452 A	48
NP 390444 / NP 750997	F 15198	42
NP 457202	CONE F 15131	48
NP 478770	CONE F 15328	48
NP 550563 / NP 546683	F 15114	34
NP 569484 / NP 644537	F 15252	36
NP 793154	F 15125	136
NP 806712 / NP 326808	F 15312	42
NP 854792 / NP 430273	F 15315	38
NP 881387 / NP 304907	F 15265	42
NP 927527	CONE F 15327	48
NP 988748 / NP 247732	F 15133	34
NP003658 / NP096839	F 15367	40
NP022042 / NP579116	594 A / 592 A	16
NP030522 / NP378917	F 15342	40
NP123221 / NP787333	F 15383	40
NP171276 / NP943289	JM 714249 / JM 714210	29
NP238750 / NP929800	F 15314	38
NP242732	CONE 72218 C	27
NP259742 / NP378917	F 15339	40
NP285701 / NP341513	F 15313	38
NP293601 / NP934397	JM 716649 / JM 716610	30
NP331249	F 15279	38
NP380290	CONE 497	15
NP380290 / NP533133	497 / 493	15
NP417384 / Y30206M	F 15313	38
NP478770 / NP547156	CONE F 15328	48
NP523912	CONE 72212 C	27
NP523912 / NP611140	72212 C / 72487	27
NP604623 / NP577617	F 15377	40
NP718852 / NP022178	F 15337	40
NP725688 / NP560412	F 15291	38
NP765903 / NP919474	F 15311	42
NP797735 / NP430273	F 15338	40
NP799449	CONE 567	16
NP799449 / NP105857	567 / 563	16

14.3 \ Cross part number

Cruces de referencias

COMPETITOR	Fersa	PG.
TIMKEN		
NP802577/NP896994	F 15366	40
NP846736/NP166419	65237/65500	26
NP868033/NP666556	F 15316	38
NP903590/NP640324	F 15384	40
NP925485/NP312842	F 15376	40
NP928171/NP718759	598/592 A	16
NP930036	CONE 555 S	16
NP930036/NP193660	555 S/552 A	16
NP970652/NP563664	JP 10049/JP 10010	20
SET 1	LM 11749/LM 11710	20
SET 10	U 399/U 360 L-A	44
SET 1010	27690/27620	23
SET 1015	30206 F	8
SET 1016	30207 F	8
SET 1017	30208 F	8
SET 1018	30209 F	8
SET 1019	30210 F	8
SET 102	3585/3525	18
SET 1020	30212 F	8
SET 1021	30214 F	8
SET 1022	30216 F	8
SET 1023	30217 F	8
SET 1024	30218 F	8
SET 1025	30220 F	8
SET 1026	30221 F	8
SET 1029	30306 F	8
SET 103	3982/3920	18
SET 1030	30307 F	8
SET 1031	30309 F	9
SET 1032	30312 F	9
SET 1033	30313 F	9
SET 1034	30314 F	9
SET 1035	31312 F	9
SET 1040	32010 XF	10
SET 1041	32011 XF	10
SET 1042	32012 XF	10
SET 1043	32013 XF	10
SET 1044	32014 XF	10
SET 1045	32015 XF	10
SET 1046	32016 XF	10
SET 1047	32017 XF	10
SET 1049	32019 XF	10
SET 105	33287/33462	24
SET 1050	32020 XF	10
SET 1052	32022 XF	10
SET 1053	32024 XF	10

COMPETITOR	Fersa	PG.
SET 1058	32209 F	10
SET 1059	32210 F	10
SET 106	LM 78349/LM 78310 A	27
SET 1060	32211 F	10
SET 1061	32212 F	10
SET 1062	32213 F	11
SET 1063	32214 F	11
SET 1064	32215 F	11
SET 1065	32216 F	11
SET 1066	32217 F	11
SET 1067	32218 F	11
SET 1068	32219 F	11
SET 1069	32220 F	11
SET 107	JLM 104948/JLM 104910	28
SET 1070	32221 F	11
SET 1072	32304 F	11
SET 1074	32306 F	11
SET 1075	32307 F	11
SET 1076	32308 F	11
SET 1078	32309 F	11
SET 1079	32310 F	11
SET 108	JHM 807045/JHM 807012	30
SET 1080	32311 F	11
SET 1081	32312 F	11
SET 1082	32313 F	11
SET 1083	32314 F	11
SET 1084	32316 F	11
SET 1085	32924 F	12
SET 1086	33011 F	12
SET 1088	33014 F	12
SET 1089	33015 F	12
SET 109	683/672	17
SET 1090	33018 F	12
SET 1091	33019 F	12
SET 1092	33020 F	12
SET 1093	33021 F	12
SET 1094	33022 F	12
SET 1096	33108 F	12
SET 1097	33109 F	12
SET 1098	33111 F	12
SET 1099	33112 F	12
SET 11	JL 69349/JL 69310	27
SET 110	6379/6320	19
SET 1100	33113 F	12
SET 1101	33115 F	12
SET 1102	33116 F	12
SET 1103	33117 F	12

COMPETITOR	Fersa	PG.
TIMKEN		
SET 1104	33118 F	12
SET 1106	33206 F	13
SET 1107	33207 F	13
SET 1108	33208 F	13
SET 1109	33209 F	13
SET 111	48290/48220	26
SET 1110	33210 F	13
SET 1111	33211 F	13
SET 1112	33212 F	13
SET 1113	33213 F	13
SET 1114	33214 F	13
SET 1115	33215 F	13
SET 1116	33216 F	13
SET 1117	33217 F	13
SET 1119	3490/3420	18
SET 1122	37431 A/37625	25
SET 1123	387 A/382	14
SET 1124	39580/39528	25
SET 1125	395 S/394 A	15
SET 1127	4580/4535	19
SET 113	HM 215249/HM 215210	28
SET 1133	5395/5335	19
SET 1135	575/572	16
SET 1137	580/572 X	16
SET 1138	594 A/592 A	16
SET 114	H 212749/H 212710	28
SET 1141	665 A/653	17
SET 1143	9278/9220	19
SET 1144	9285/9220	19
SET 1146	H 414242/H 414210	28
SET 1148	H 715332/H 715311	29
SET 1150	HM 204043/HM 204010	28
SET 1152	HM 212049/HM 212010	28
SET 1158	HM 807048/HM 807010	30
SET 1163	JF 6049/JF 6010	19
SET 1164	JF 7049/JF 7010	19
SET 1165	JF 7049 A/JF 7010	19
SET 1166	JF 9549/JF 9510	19
SET 1169	JHM 720249/JHM 720210	30
SET 117	64450/64700	26
SET 1176	JM 207049/JM 207010	28
SET 1177	JM 207049 A/JM 207010	28
SET 1178	JM 511946/JM 511910	29
SET 1179	JM 515649/JM 515610	29
SET 118	JLM 506849/JLM 506810	29
SET 1180	JM 612949/JM 612910	29

COMPETITOR	Fersa	PG.
SET 1182	JM 718149/JM 718110	30
SET 1183	JM 719149/JM 719113	30
SET 1184	JM 822049/JM 822010	31
SET 1192	JW 5549/JW 5510	19
SET 1193	JW 6049/JW 6010	19
SET 12	LM 12749/LM 12710	20
SET 1207	32015 XF	10
SET 121	18790/18720	22
SET 1216	L 910349/L 910310	31
SET 122	25580/25522	23
SET 1227	LM 806649/LM 806610	30
SET 123	3780/3720	18
SET 1231	F 15097	136
SET 1231 / NP 078914	F 15097	136
SET 1237	F 15126	136
SET 1242	F 15122	136
SET 1263	F 15127	136
SET 1265	F 15321	38
SET 1277	F 15126	136
SET 1296	JF 5049/JF 5010	19
SET 1297	JF 4549/JF 4510	19
SET 1299	F 15115	34
SET 13	L 68149/L 68110	27
SET 1300	F 15051 R	32
SET 1301	F 15051 C	32
SET 1303	33020 F 561694	12
SET 1304	33216 F 573810	13
SET 1306	33021 F 0266488	12
SET 1308	JF 10049/JF 10010	20
SET 1309	33220 F	13
SET 1310	F 15100	136
SET 1311	F 200015	138
SET 1312	F 200013	138
SET 1314	F 200014	138
SET 1321	F 15300	136
SET 1328	F 15271	36
SET 1334	F 300001	142
SET 1335	F 200004	138
SET 1343	33017 F	12
SET 1346	F 200016	138
SET 1349	F 15120	136
SET 1350	F 300003	142
SET 1351	F 200019	140
SET 1352	F 200017	140
SET 1368	F 15302	54
SET 1370	F 200025	140
SET 14	L 44643/L 44610	25

14.3 \ Cross part number Cruces de referencias

COMPETITOR	Fersa	PG.
TIMKEN		
SET 15	07100/07196	20
SET 16	LM 12749/LM 12711	20
SET 17	L 68149/L 68111	27
SET 2	LM 11949/LM 11910	20
SET 20	U 399/U 365 L-C	44
SET 205	469/453 X	15
SET 21	1988/1922	17
SET 210	527/522	15
SET 212	537/532 X	16
SET 214	559/552 A	16
SET 215	575/572 X	16
SET 216	594/592 A	16
SET 226	1380/1328	17
SET 229	2780/2720	17
SET 230	2788/2720	17
SET 238	JF 4049/JF 4010	19
SET 24	JL 68145/JL 68111 Z	27
SET 240	JW 5049/JW 5010	19
SET 241	6386/6320	19
SET 243	JD 6549/JD 6510	19
SET 244	JF 7049 A/JF 7010	19
SET 251	15103 S/15243	21
SET 252	15106/15250 X	22
SET 253	18590/18520	22
SET 26	JLM 104946/JLM 104910	28
SET 260	25877/25821	23
SET 262	27687/27620	23
SET 263	28580/28521	23
SET 267	29685/29620	24
SET 268	LM 29749/LM 29711	24
SET 270	33885/33822	24
SET 271	33889/33822	24
SET 272	33895/33822	24
SET 276	39580/39520	25
SET 278	39581/39520	25
SET 279	39585/39520	25
SET 28	J 15585/15520	22
SET 281	42381/42584	25
SET 289	52400/52618	26
SET 293	55200 C/55437	26
SET 3	M 12649/M 12610	20
SET 302	68462/68712	27
SET 304	72212 C/72487	27
SET 307	09074/09194	20
SET 308	M 84548/M 84510	27
SET 309	M 86649/M 86610	27

COMPETITOR	Fersa	PG.
SET 312	HM 89449/HM 89410	28
SET 315	JM 205149/JM 205110	28
SET 317	HM 220149/HM 220110	28
SET 318	LM 300849/LM 300811	28
SET 320	JLM 508748/JLM 508710	29
SET 321	25877/25820	23
SET 322	495 A/493	15
SET 323	JHM 522649/JHM 522610	29
SET 324	JLM 714149/JLM 714110	29
SET 325	JM 714249/JM 714210	29
SET 328	M 802048/M 802011	30
SET 330	HM 803146/HM 803110	30
SET 336	JL 819349/JL 819310	31
SET 339	HM 911245/HM 911210	31
SET 340	H 913842/H 913810	31
SET 341	H 913843/H 913810	31
SET 342	JLM 710949 C/JLM 710910	29
SET 349	567/563	16
SET 354	15103 S/15245	21
SET 355	15579 X/15520	22
SET 357	28584/28521	24
SET 36	LM 603049/LM 603012	29
SET 361	JM 716649/JM 716610	30
SET 362	02474/02420	19
SET 363	55175 C/55437	26
SET 364	37431 A/37625	25
SET 365	395 A/394 A	15
SET 37	LM 603049/LM 603011	29
SET 38	LM 104949/LM 104911	28
SET 4	L 44649/L 44610	25
SET 401	580/572	16
SET 403	594 A/592 A	16
SET 404	598 A/592 A	16
SET 405	663/653	17
SET 406	3782/3720	18
SET 407	28682/28622	24
SET 408	39590/39520	25
SET 410	45284/45220	25
SET 411	47686/47620	26
SET 412	HM 212047/HM 212011	28
SET 413	HM 212049/HM 212011	28
SET 414	HM 218248/HM 218210	28
SET 415	HM 518445/HM 518410	29
SET 417	47890/47820	26
SET 418	H 715334/H 715311	29

COMPETITOR	Fersa	PG.
TIMKEN		
SET 419	H 715343/H 715311	29
SET 42	JLM 506849 A/JLM 506811	29
SET 420	H 715345/H 715311	30
SET 422	HM 516449 C/HM 516410	29
SET 423	6461/6420	19
SET 424	555 S/552 A	16
SET 425	567/563	16
SET 426	47679/47620	26
SET 43	15123/15245	22
SET 45	LM 501349/LM 501310	29
SET 46	JL 26749 F/JL 26710	23
SET 47	LM 102949/LM 102910	28
SET 5	LM 48548/LM 48510	26
SET 50	02872/02820	19
SET 508	687/672	17
SET 51	15106/15245	21
SET 52	25580/25520	23
SET 53	25580/25523	23
SET 54	25590/25520	23
SET 55	25590/25523	23
SET 56	LM 29748/LM 29710	24
SET 57	31594/31520	24
SET 6	LM 67048/LM 67010	26
SET 61	11590/11520	20
SET 62	17887/17831	22
SET 63	M 88048/M 88010	27
SET 64	HM 903249/HM 903210	31
SET 65	M 86647/M 86610	27
SET 66	368 S/362	14
SET 67	HM 88649/HM 88610	28
SET 68	497/493	15
SET 69	LM 501349/LM 501314	29
SET 70	LM 29749/LM 29710	24
SET 73	15101/15245	21
SET 74	387 A/382 A	14
SET 75	387 A/382 S	14
SET 76	387 AS/382 A	14
SET 77	388 A/382	14
SET 78	55200 C/55437	26
SET 79	56425/56650	26
SET 8	L 45449/L 45410	25
SET 80	U 497/U 460 L	44
SET 81	HM 88542/HM 88510	27
SET 82	LM 104949/JLM 104910	28
SET 83	HM 803149/HM 803110	30
SET 84	HM 807040/HM 807010	30

COMPETITOR	Fersa	PG.
SET 85	25880/25820	23
SET 9	U 298/U 261 L-C	44
SET 927	740/742	17
SET 928	47490/47420	25
SET 929	759/752	17
SET 95	2580/2523	17
SET 98	3984/3920	18
SET702	F 15383	40
SET703	F 15384	40
T119	T 119	60
TKR 8572	F 16082	88
XAA33115	33115 F	12
XC 06536 CD / JXC 06536 DC	F 15108	42
XC110240CG / L45410	F 15029	32
XC25378FK	F 15371	40
XGA 33211	F 15047	32
XGA32021X	F 15272	38

TORRINGTON		
544740 B	F 19032	120
BS 500082	F 19095	122
BS226539V	F 19094	122
BS500052V	F 19067	120
BS500192S	F 19085	122
M 1206 EL	F 19068	120
MR 1211 GEL	F 19101	122
MS 1211 REX	F 19101	122
MSN 211 REX	F 19101	122
MU 1212 RUMW3	F 19088	122
MU 1307 TM	F 19077	122
MU 1308 TVWS	F 19119	124
MU 1308 UM	F 19034	120
MU1305TDM	F 19040	120
MU1308TV	F 19119	124
MU1308TVWS	F 19119	124
MUB 7309 UM	F 19063	120
MUB1307UBM	F 19100	122
MUB1308UM	F 19084	122
MUB5207UM	F 19086	122
MUB7307UM	F 19099	122
MUS 1307 TM	F 19078	122
MUS1307UM	F 19083	122
MUSB 7307 UM	F 19120	124
RU 1570 UM	F 19035	120
RU 9008 UM	F 19033	120



A series of horizontal dotted lines spanning the width of the page, providing a guide for handwriting practice. The lines are evenly spaced and extend from the left margin to the right margin.



A series of horizontal dotted lines spanning the width of the page, providing a guide for handwriting practice. The lines are evenly spaced and extend from the left margin to the right margin.



A series of horizontal dotted lines spanning the width of the page, providing a guide for handwriting practice. The lines are evenly spaced and extend from the left margin to the right margin.



A series of horizontal dotted lines spanning the width of the page, providing a guide for handwriting practice. The lines are evenly spaced and extend from the left margin to the right margin.



A series of horizontal dotted lines spanning the width of the page, providing a guide for handwriting practice. The lines are evenly spaced and extend from the left margin to the right margin.



A series of horizontal dotted lines spanning the width of the page, providing a guide for handwriting practice. The lines are evenly spaced and extend from the left margin to the right margin.



A series of horizontal dotted lines spanning the width of the page, providing a guide for handwriting practice. The lines are evenly spaced and extend from the left margin to the right margin.



A series of horizontal dotted lines spanning the width of the page, providing a guide for handwriting practice. The lines are evenly spaced and extend from the left margin to the right margin.



A series of horizontal dotted lines spanning the width of the page, providing a guide for handwriting practice. The lines are evenly spaced and extend from the left margin to the right margin.



A series of horizontal dotted lines spanning the width of the page, providing a guide for handwriting practice. The lines are evenly spaced and extend from the left margin to the right margin.



A series of horizontal dotted lines spanning the width of the page, providing a guide for handwriting practice. The lines are evenly spaced and extend from the left margin to the right margin.

EXPERTS IN BEARING SOLUTIONS

INNOVATIVE SPIRIT

EUROPE Spain | Zaragoza

Headquarters
Tlf: +34 976 333 850
fersa@fersa.com

Regional branch
Tlf: +34 876 269 571
fersaiberia@fersa.com

NORTH AMERICA U.S.A | Ohio

Tlf: +1 567-661 0806
fersa.usa@fersa.com

ASIA China | Jiaxing

Tlf: +86 (0) 573 8398 7788
fersa.cn@fersa.com

SOUTH AMERICA Brazil | Sao Paulo

Tlf: +55 41 3132 5100
fersa.brasil@fersa.com

www.fersa.com

CAT SUMMARY

