

MACHINED RING NEEDLE ROLLER BEARINGS

WITHOUT INNER RING

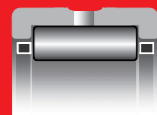

RNA49, RNA59, RNA69 (F_w ≤ 35), NK

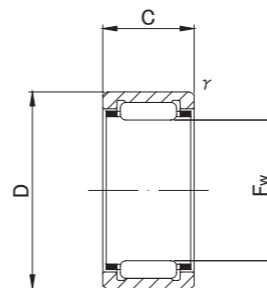

NK (F_w ≤ 10)

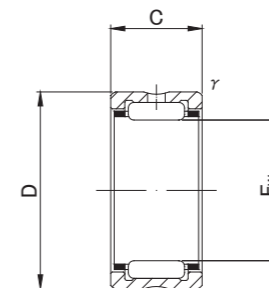

RNA49, RNA59, RNA69 (F_w ≤ 35), NK

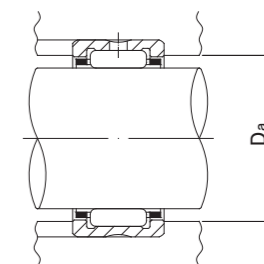

RNA49, RNA59, RNA69, RNA48, NK TYPE

Shaft Diameter (mm)	Designation					Dimensions (mm)				Standard mounting dimensions (mm)	Basic dynamic load rating	Basic static load rating	Limiting speed *	Mass	Usable bearing designation								
	RNA 49	RNA 59	RNA 69	RNA 48	NK	F _w	D	C	t/s min						Da MAX	Cr N	Cor N	rpm	g (approx)	INNER RING	WITH INNER RING		
5	—	—	—	—	NK5/10 NK5/12	5 +0.018	10	10	0.15	6.5	2 420	1 950	40 000	3.4	—	—							
	—	—	—	—		5 +0.010	10	12	0.15								6.5	3 080	2 660	40 000	4.2		
6	—	—	—	—	NK6/10 NK6/12	6 +0.018	12	10	0.15	7.5	2 700	2 320	37 000	5.3	—	—							
	—	—	—	—		6 +0.010	12	12	0.15								7.5	3 440	3 170	37 000	6.4		
7	RNA 495	—	—	—	—	7 +0.022	13	10	0.15	8.5	2 960	2 690	34 000	5.9	IR5710	NA495							
	—	—	—	—	NK7/10	7 +0.013	14	10	0.3								8.5	3 600	2 960	34 000	6.9	—	—
	—	—	—	—	NK7/12	7	14	12	0.3								8.5	4 610	4 050	34 000	8.3	—	—
8	RNA 496	—	—	—	—	8 +0.022	15	10	0.15	13.8	3 900	3 400	32 000	7.3	IR6810	NA496							
	—	—	—	—	NK8/12	8 +0.013	15	12	0.3								13	5 100	4 700	32 000	9	IR5812	NKI 5/12
	—	—	—	—	NK8/16	8	15	16	0.3								13	7 100	7 300	32 000	13	IR5816	NKI 5/16
9	—	—	—	—	NK9/12 NK9/16	9 +0.022	16	12	0.3	14	5 500	5 300	30 000	10	IR6912	NKI 6/12							
	—	—	—	—		9 +0.013	16	16	0.3								14	7 600	8 200	30 000	13.2	IR6916	NKI 6/16
	RNA 497	—	—	—	—	9	17	10	0.15								15.8	4 500	3 600	30 000	9.3	IR7910	NA497
10	—	—	—	—	NK10/12 NK10/16	10 +0.022	17	12	0.3	15	5 900	6 000	28 000	10.7	IR71012	NKI 7/12							
	—	—	—	—		10 +0.013	17	16	0.3								15	8 200	9 200	28 000	14.3	IR71016	NKI 7/16
	RNA 498	—	—	—	—	10	19	11	0.2								17.4	6 200	5 000	28 000	12.6	IR81011	NA498
12	—	—	—	—	NK12/12 NK12/16	12 +0.027	19	12	0.3	17	6 600	7 300	26 000	12.2	IR91212	NKI 9/12							
	—	—	—	—		12 +0.016	19	16	0.3								17	9 200	11 200	26 000	16.3	IR91216	NKI 9/16
	RNA 499	—	—	—	—	12	20	11	0.3								18	6 600	6 300	26 000	13.6	IR91211	NA499

* Suitable for oil lubrication. In case of grease lubrication, down to 60% of this value.

MACHINED RING NEEDLE ROLLER BEARINGS

WITHOUT INNER RING

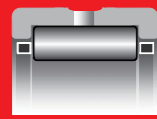

RNA49, RNA59, RNA69 (F_w ≤ 35), NK

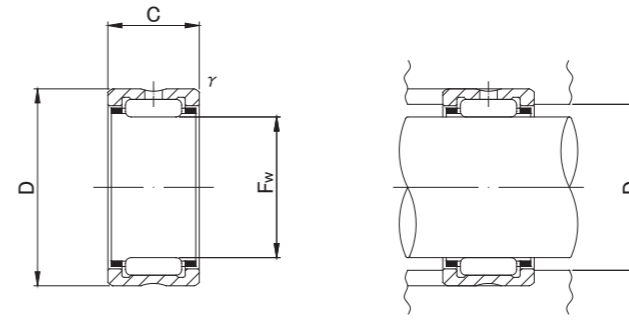

RNA49, RNA59, RNA69 (F_w ≤ 35), NK

RNA49, RNA59, RNA69, RNA48, NK TYPE

Shaft Diameter (mm)	Designation					Dimensions (mm)				Standard mounting dimensions (mm)	Basic dynamic load rating	Basic static load rating	Limiting speed *	Mass	Usable bearing designation								
	RNA 49	RNA 59	RNA 69	RNA 48	NK	F _w	D	C	r/s min						Da MAX	Cr N	Cor N	rpm	g (approx)	INNER RING	WITH INNER RING		
14	RNA 4900	—	—	—	—	14	+0.027 +0.016	22	13	0.3	20	9 200	10 100	24 000	16.5	IR101413	NA4900						
	—	—	—	—	NK14/16	14		22	16	0.3							20	11 800	13 700	24 000	21	IR101416	NKI 10/16
	—	—	—	—	NK14/20	14		22	20	0.3							20	14 800	18 500	24 000	26.5	IR101420	NKI 10/20
15	—	—	—	—	NK15/16	15	+0.027	23	16	0.3	21	12 400	14 900	23 000	22.5	—	—						
	—	—	—	—	NK15/20	15	+0.016	23	20	0.3								21	15 600	20 200	23 000	28	—
16	RNA 4901	—	—	—	—	16	+0.027 +0.016	24	13	0.3	22	9 700	11 100	23 000	18.1	IR121613	NA4901						
	—	—	—	—	NK16/16	16		24	16	0.3							22	12 300	15 100	23 000	23	IR121616	NKI 12/16
	—	—	—	—	NK16/20	16		24	20	0.3							22	15 600	20 400	23 000	29	IR121620	NKI 12/20
	—	—	RNA 6901	—	—	16		24	22	0.3							22	17 100	23 000	23 000	30	IR121622	NA6901
17	—	—	—	—	NK17/16	17	+0.027	25	16	0.3	23	12 800	16 300	22 000	24.5	—	—						
	—	—	—	—	NK17/20	17	+0.016	25	20	0.3								23	16 300	22 100	22 000	30.5	—
18	—	—	—	—	NK18/16	18	+0.027	26	16	0.3	24	13 400	17 500	21 000	25.5	—	—						
	—	—	—	—	NK18/20	18	+0.016	26	20	0.3								24	17 000	23 600	21 000	32	—
19	—	—	—	—	NK19/16	19	+0.033	27	16	0.3	25	14 000	18 700	21 000	27	IR151916	NKI 15/16						
	—	—	—	—	NK19/20	19	+0.020	27	20	0.3							25	17 700	25 300	21 000	34	IR151920	NKI 15/20
20	RNA 4902	—	—	—	—	20	+0.033 +0.020	28	13	0.3	26	10 900	13 800	20 000	21.5	IR152013	NA4902						
	—	—	—	—	NK20/16	20		28	16	0.3							26	13 900	18 700	20 000	27.5	—	—
	—	RNA 5902	—	—	—	20		28	18	0.3							26	15 700	22 100	20 000	33	IR152018	NA5902
	—	—	—	—	NK20/20	20		28	20	0.3							26	17 600	25 400	20 000	35.5	—	—
	—	—	RNA 6902	—	—	20		28	23	0.3							26	19 300	28 700	20 000	37	IR152023	NA6902

* Suitable for oil lubrication. In case of grease lubrication, down to 60% of this value.

MACHINED RING NEEDLE ROLLER BEARINGS

WITHOUT INNER RING

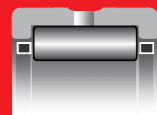

RNA49, RNA59, RNA69 (F_w ≤ 35), NK

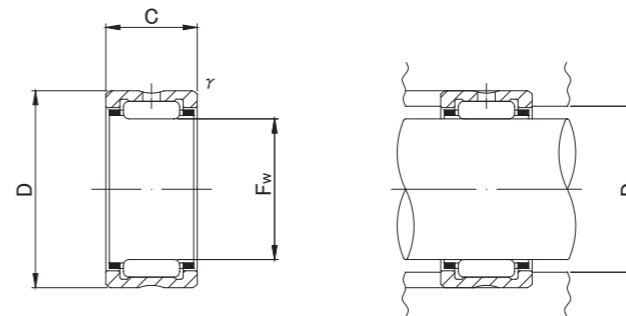

RNA49, RNA59, RNA69 (F_w ≤ 35), NK

RNA49, RNA59, RNA69, RNA48, NK TYPE

Shaft Diameter (mm)	Designation					Dimensions (mm)				Standard mounting dimensions (mm)	Basic dynamic load rating	Basic static load rating	Limiting speed *	Mass	Usable bearing designation								
	RNA 49	RNA 59	RNA 69	RNA 48	NK	F _w	D	C	t/s min						Da MAX	Cr N	Cor N	rpm	g (approx)	INNER RING	WITH INNER RING		
21	—	—	—	—	NK21/16 NK21/20	21 +0.033	29	16	0.3	27	14 400	20 000	19 000	29	IR172116	NKI 17/16							
	—	—	—	—		21 +0.020	29	20	0.3								27	18 200	27 100	19 000	36	IR172120	NKI 17/20
22	RNA 4903	—	—	—	— NK22/16 — NK22/20 —	22	30	13	0.3	28	11 800	15 600	18 000	23.5	IR172213	NA4903							
	—	—	—	—		22	30	16	0.3								28	14 900	21 200	18 000	30	—	—
	—	RNA 5903	—	—		22 +0.033	30	18	0.3								28	16 900	24 900	18 000	35	IR172218	NA5903
	—	—	—	—		22 +0.020	30	20	0.3								28	18 900	28 700	18 000	37.5	—	—
	—	—	RNA 6903	—		22	30	23	0.3								28	20 800	32 500	18 000	40.5	IR172223	NA6903
24	—	—	—	—	NK24/16 NK24/20	24 +0.033	32	16	0.3	30	15 300	22 600	17 000	32	IR202416	NKI 20/16							
	—	—	—	—		24 +0.020	32	20	0.3								30	19 400	30 500	17 000	40.5	IR202420	NKI 20/20
25	—	—	—	—	NK25/16 NK25/20 — — —	25	33	16	0.3	31	15 800	23 700	16 000	33.5	—	—							
	—	—	—	—		25	33	20	0.3								31	20 000	32 200	16 000	42	—	—
	RNA 4904	—	—	—		25 +0.033	37	17	0.3								35	21 000	25 000	16 000	55.5	IR202517	NA4904
	—	RNA 5904	—	—		25 +0.020	37	23	0.3								35	29 400	38 600	16 000	84	IR202523	NA5904
	—	—	RNA 6904	—		25	37	30	0.3								35	35 400	48 800	16 000	95.5	IR202530	NA6904
26	—	—	—	—	NK26/16 NK26/20	26 +0.033	34	16	0.3	32	16 300	24 900	15 000	34.5	IR222616	NKI 22/16							
	—	—	—	—		26 +0.020	34	20	0.3								32	20 600	33 700	15 000	43.5	IR222620	NKI 22/20
28	—	—	—	—	NK28/20 NK28/30 — — —	28	37	20	0.3	35	21 700	37 100	14 000	51.5	—	—							
	—	—	—	—		28	37	30	0.3								35	31 100	58 900	14 000	83.5	—	—
	RNA 49/22	—	—	—		28 +0.033	39	17	0.3								37	21 400	28 800	14 000	56.5	IR222817	NA49/22
	—	RNA 59/22	—	—		28 +0.020	39	23	0.3								37	29 800	44 400	14 000	92	IR222823	NA59/22
	—	—	RNA 69/22	—		28	39	30	0.3								37	36 300	56 900	14 000	97.5	IR222830	NA69/22
29	—	—	—	—	NK29/20 NK29/30	29 +0.033	38	20	0.3	36	21 600	37 200	14 000	57	IR252920	NKI 25/20							
	—	—	—	—		29 +0.020	38	30	0.3								36	30 900	59 000	14 000	85	IR252930	NKI 25/30

* Suitable for oil lubrication. In case of grease lubrication, down to 60% of this value.

MACHINED RING NEEDLE ROLLER BEARINGS

WITHOUT INNER RING

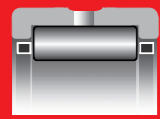

RNA49, RNA59, RNA69 ($F_w \leq 35$), NK RNA69

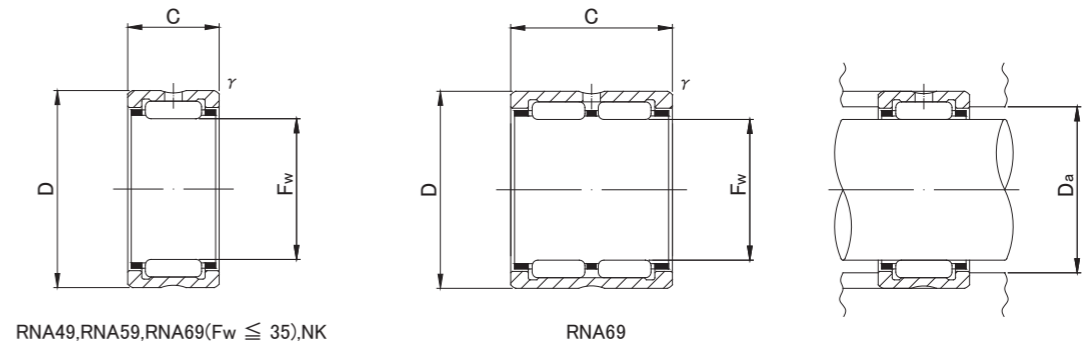

RNA49, RNA59, RNA69 ($F_w \leq 35$), NK

RNA69

RNA49, RNA59, RNA69, RNA48, NK TYPE

Shaft Diameter (mm)	Designation					Dimensions (mm)				Standard mounting dimensions (mm)	Basic dynamic load rating	Basic static load rating	Limiting speed *	Mass	Usable bearing designation	
	RNA 49	RNA 59	RNA 69	RNA 48	NK	F_w	D	C	t/s min						D_a MAX	Cr N
30	—	—	—	—	NK30/20	30	40	20	0.3	38	25 100	40 100	13 000	64.5	—	—
	—	—	—	—	NK30/30	30	40	30	0.3	38	36 000	63 800	13 000	97.5	—	—
	RNA 4905	—	—	—	—	30	42	17	0.3	40	23 700	30 700	13 000	64	IR253017	NA4905
	—	RNA 5905	—	—	—	30	42	23	0.3	40	33 200	47 500	13 000	101	IR253023	NA5905
	—	—	RNA 6905	—	—	30	42	30	0.3	40	42 100	64 200	13 000	111	IR253030	NA6905
32	—	—	—	—	NK32/20	32	42	20	0.3	40	25 700	42 200	13 000	68	IR283220	NKI 28/20
	—	—	—	—	NK32/30	32	42	30	0.3	40	36 900	67 100	13 000	102	IR283230	NKI 28/30
	RNA 49/28	—	—	—	—	32	45	17	0.3	43	24 500	32 700	13 000	76.5	IR283217	NA49/28
	—	RNA 59/28	—	—	—	32	45	23	0.3	43	34 300	50 500	13 000	108	IR283223	NA59/28
	—	—	RNA 69/28	—	—	32	45	30	0.3	43	41 800	64 700	13 000	133	IR283230	NA69/28
35	—	—	—	—	NK35/20	35	45	20	0.3	43	27 000	46 200	11 000	73.5	IR303520	NKI 30/20
	—	—	—	—	NK35/30	35	45	30	0.3	43	38 600	73 500	11 000	112	IR303530	NKI 30/30
	RNA 4906	—	—	—	—	35	47	17	0.3	45	25 200	34 700	11 000	72.5	IR303517	NA4906
	—	RNA 5906	—	—	—	35	47	23	0.3	45	35 200	53 700	11 000	108	IR303523	NA5906
	—	—	RNA 6906	—	—	35	47	30	0.3	45	43 100	69 000	11 000	125	IR303530	NA6906
37	—	—	—	—	NK37/20	37	47	20	0.3	45	28 200	50 100	11 000	77.5	IR323720	NKI 32/20
	—	—	—	—	NK37/30	37	47	30	0.3	45	40 500	79 800	11 000	117	IR323730	NKI 32/30
38	—	—	—	—	NK38/20	38	48	20	0.3	46	28 100	50 200	11 000	79	—	—
	—	—	—	—	NK38/30	38	48	30	0.3	46	40 300	80 000	11 000	119	—	—
40	—	—	—	—	NK40/20	40	50	20	0.3	48	29 400	54 100	10 000	83	IR354020	NKI 35/20
	—	—	—	—	NK40/30	40	50	30	0.3	48	42 300	86 100	10 000	125	IR354030	NKI 35/30
	RNA 49/32	—	—	—	—	40	52	20	0.6	48	31 300	47 900	10 000	96	IR324020	NA49/32
	—	RNA 59/32	—	—	—	40	52	27	0.6	48	41 900	69 900	10 000	149	IR324027	NA59/32
	—	—	RNA 69/32	—	—	40	52	36	0.6	48	53 500	95 700	10 000	172	IR324036	NA69/32
42	—	—	—	—	NK42/20	42	52	20	0.3	50	29 900	56 200	9 500	86.5	—	—
	—	—	—	—	NK42/30	42	52	30	0.3	50	43 000	89 500	9 500	130	—	—
	RNA 4907	—	—	—	—	42	55	20	0.6	51	32 000	50 200	9 500	113	IR354220	NA4907
	—	RNA 5907	—	—	—	42	55	27	0.6	51	42 900	73 200	9 500	176	IR354227	NA5907
	—	—	RNA 6907	—	—	42	55	36	0.6	51	54 800	100 000	9 500	200	IR354236	NA6907

* Suitable for oil lubrication. In case of grease lubrication, down to 60% of this value.

MACHINED RING NEEDLE ROLLER BEARINGS

WITHOUT INNER RING

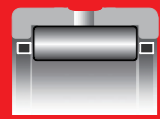

RNA49, RNA59, RNA48, NK



RNA69

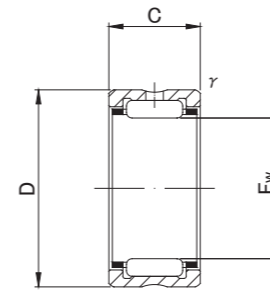

RNA49, RNA59, RNA48, NK

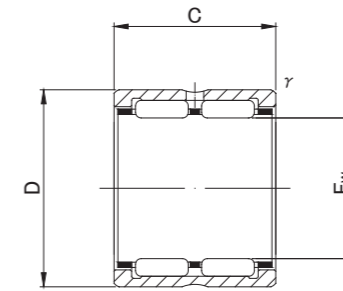

RNA69

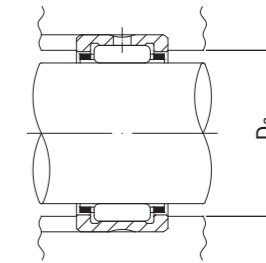

RNA49, RNA59, RNA69, RNA48, NK TYPE

Shaft Diameter (mm)	Designation					Dimensions (mm)				Standard mounting dimensions (mm)	Basic dynamic load rating	Basic static load rating	Limiting speed *	Mass	Usable bearing designation						
	RNA 49	RNA 59	RNA 69	RNA 48	NK	Fw	D	C	t's min						Da MAX	Cr N	Cor N	rpm	g (approx)	INNER RING	WITH INNER RING
43	—	—	—	—	NK43/20 NK43/30	43 +0.041	53	20	0.3	51	30 500	58 100	9 500	88.5	IR384320 IR384330	NKI 38/20 NKI 38/30					
	—	—	—	—		43 +0.025	53	30	0.3								51	43 700	92 500	9 500	133
45	—	—	—	—	NK45/20 NK45/30	45 +0.041	55	20	0.3	53	31 100	60 100	9 000	92	IR404520 IR404530	NKI 40/20 NKI 40/30					
	—	—	—	—		45 +0.025	55	30	0.3								53	44 500	95 700	9 000	138
47	—	—	—	—	NK47/20 NK47/30	47 +0.041	57	20	0.3	55	31 500	62 300	8 500	95	IR424720 IR424730	NKI 42/20 NKI 42/30					
	—	—	—	—		47 +0.025	57	30	0.3								55	45 200	99 000	8 500	144
48	RNA 4908	—	—	—	—	48 +0.041	62	22	0.6	58	41 600	67 400	8 500	152	IR404822 IR404830 IR404840	NA4908 NA5908 NA6908					
	—	RNA 5908	—	—		48 +0.025	62	30	0.6								58	58 000	103 000	8 500	225
	—	—	RNA 6908	—		48	62	40	0.6								58	71 300	134 400	8 500	275
50	—	—	—	—	NK50/25 NK50/35	50 +0.041	62	25	0.6	58	43 000	85 200	8 000	159	IR455025 IR455035	NKI 45/25 NKI 45/35					
	—	—	—	—		50 +0.025	62	35	0.6								58	58 100	125 500	8 000	225
52	RNA 4909	—	—	—	—	52 +0.049	68	22	0.6	64	43 500	73 400	7 500	197	IR455222 IR455230 IR455240	NA4909 NA5909 NA6909					
	—	RNA 5909	—	—		52 +0.030	68	30	0.6								64	60 700	112 000	7 500	232
	—	—	RNA 6909	—		52	68	40	0.6								64	74 600	147 100	7 500	355
55	—	—	—	—	NK55/25 NK55/35	55 +0.049	68	25	0.6	64	45 400	94 100	7 500	193	IR505525 IR505535	NKI 50/25 NKI 50/35					
	—	—	—	—		55 +0.030	68	35	0.6								64	61 300	138 300	7 500	255

* Suitable for oil lubrication. In case of grease lubrication, down to 60% of this value.

MACHINED RING NEEDLE ROLLER BEARINGS

WITHOUT INNER RING

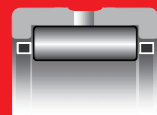

RNA49, RNA59, RNA48, NK



RNA69

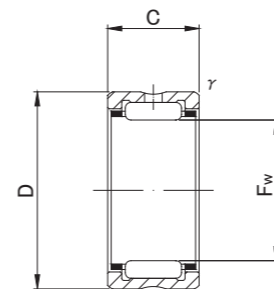

RNA49, RNA59, RNA48, NK

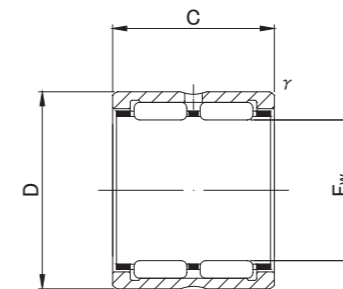

RNA69

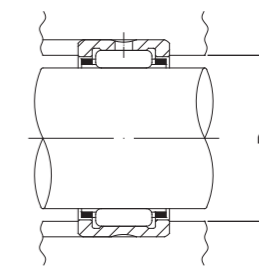

RNA49, RNA59, RNA69, RNA48, NK TYPE

Shaft Diameter (mm)	Designation					Dimensions (mm)				Standard mounting dimensions (mm)	Basic dynamic load rating	Basic static load rating	Limiting speed *	Mass	Usable bearing designation									
	RNA 49	RNA 59	RNA 69	RNA 48	NK	Fw	D	C	t's min						Da MAX	Cr N	Cor N	rpm	g (approx)	INNER RING	WITH INNER RING			
58	RNA 4910	—	—	—	—	58	+0.049 +0.030	72	22	0.6	68	46 200	82 100	7 000	179	IR505822	NA4910							
	—	RNA 5910	—	—	—	58		72	30	0.6								68	64 400	126 000	7 000	289	IR505830	NA5910
	—	—	RNA 6910	—	—	58		72	40	0.6								68	79 100	163 800	7 000	320	IR505840	NA6910
60	—	—	—	—	NK60/25	60	+0.049 +0.030	72	25	0.6	68	47 500	103 000	6 500	187	IR556025	NKI 55/25							
	—	—	—	—	NK60/35	60		72	35	0.6								68	64 100	151 000	6 500	260	IR556035	NKI 55/35
63	RNA 4911	—	—	—	—	63	+0.049 +0.030	80	25	1	75	57 600	97 300	6 500	265	IR556325	NA4911							
	—	RNA 5911	—	—	—	63		80	34	1								75	82 600	154 000	6 500	367	IR556334	NA5911
	—	—	RNA 6911	—	—	63		80	45	1								75	99 000	194 200	6 500	475	IR556345	NA6911
65	—	—	—	—	NK65/25	65	+0.049 +0.030	78	25	0.6	74	49 600	111 800	6 000	225	—	—							
	—	—	—	—	NK65/35	65		78	35	0.6								74	67 000	164 800	6 000	315	—	—
68	—	—	—	—	NK68/25	68	+0.049 +0.030	82	25	0.6	78	54 800	116 700	6 000	250	IR606825	NKI 60/25							
	—	—	—	—	NK68/35	68		82	35	0.6								78	72 100	165 700	6 000	350	IR606835	NKI 60/35
	RNA 4912	—	—	—	—	68		85	25	1								80	60 100	104 900	6 000	285	IR606825	NA4912
	—	RNA 5912	—	—	—	68		85	34	1								80	86 100	167 000	6 000	408	IR606834	NA5912
	—	—	RNA 6912	—	—	68		85	45	1								80	103 000	210 800	6 000	510	IR606845	NA6912
70	—	—	—	—	NK70/25	70	+0.049 +0.030	85	25	0.6	81	55 500	120 600	5 500	280	—	—							
	—	—	—	—	NK70/35	70		85	35	0.6								81	73 000	170 600	5 500	395	—	—
72	RNA 4913	—	—	—	—	72	+0.049 +0.030	90	25	1	85	62 800	113 800	5 500	325	IR657225	NA4913							
	—	RNA 5913	—	—	—	72		90	34	1								85	89 900	180 000	5 500	462	IR657234	NA5913
	—	—	RNA 6913	—	—	72		90	45	1								85	107 900	226 500	5 500	585	IR657245	NA6913

* Suitable for oil lubrication. In case of grease lubrication, down to 60% of this value.

MACHINED RING NEEDLE ROLLER BEARINGS

WITHOUT INNER RING

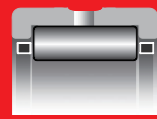

RNA49, RNA59, RNA48, NK



RNA69

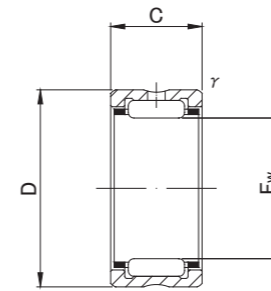

RNA49, RNA59, RNA48, NK

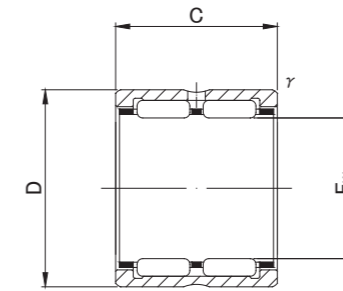

RNA69

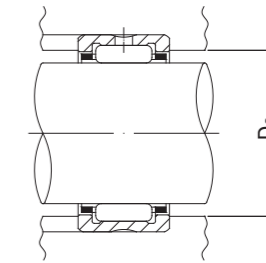

RNA49, RNA59, RNA69, RNA48, NK TYPE

Shaft Diameter (mm)	Designation					Dimensions (mm)				Standard mounting dimensions (mm)	Basic dynamic load rating	Basic static load rating	Limiting speed *	Mass	Usable bearing designation								
	RNA 49	RNA 59	RNA 69	RNA 48	NK	Fw	D	C	t/s min						Da MAX	Cr N	Cor N	rpm	g (approx)	INNER RING	WITH INNER RING		
73	—	—	—	—	NK73/25 NK73/35	73 +0.049	90	25	0.6	86	61 100	126 500	5 500	335	—	—							
	—	—	—	—		73 +0.030	90	35	0.6								86	80 400	180 400	5 500	475	IR657335	NKI 65/35
75	—	—	—	—	NK75/25 NK75/35	75 +0.049	92	25	0.6	88	62 200	130 400	5 500	345	—	—							
	—	—	—	—		75 +0.030	92	35	0.6								88	82 700	186 300	5 500	485	—	—
80	—	—	—	—	NK80/25 NK80/35	80	95	25	1	90	59 400	137 300	5 000	315	IR708025	NKI 70/25							
	—	—	—	—		80	95	35	1								90	78 100	194 200	5 000	445	IR708035	NKI 70/35
	RNA 4914	—	—	—		80 +0.049	100	30	1								95	83 200	157 900	5 000	495	IR708030	NA4914
	—	RNA 5914	—	—		80 +0.030	100	40	1								95	112 000	232 000	5 000	706	IR708040	NA5914
	—	—	RNA 6914	—		80	100	54	1								95	133 400	310 900	5 000	910	IR708054	NA6914
85	—	—	—	—	NK85/25 NK85/35	85	105	25	1	100	76 400	145 100	4 500	435	IR758525	NKI 75/25							
	RNA 4915	—	—	—		85	105	30	1								100	86 200	169 700	4 500	525	IR758530	NA4915
	—	—	—	—		85 +0.058	105	35	1								100	102 000	209 900	4 500	610	IR758535	NKI 75/35
	—	RNA 5915	—	—		85 +0.036	105	40	1								100	116 000	249 000	4 500	745	IR758540	NA5915
	—	—	RNA 6915	—		85	105	54	1								100	138 300	330 500	4 500	960	IR758554	NA6915
90	—	—	—	—	NK90/25 NK90/35	90	110	25	1	105	77 400	150 000	4 500	456	IR809025	NKI 80/25							
	RNA 4916	—	—	—		90	110	30	1								105	87 400	174 600	4 500	550	IR809030	NA4916
	—	—	—	—		90 +0.058	110	35	1								105	103 000	216 700	4 500	640	IR809035	NKI 80/35
	—	RNA 5916	—	—		90 +0.036	110	40	1								105	117 000	257 000	4 500	787	IR809040	NA5916
	—	—	RNA 6916	—		90	110	54	1								105	143 200	350 100	4 500	1 010	IR809054	NA6916
95	—	—	—	—	NK95/26 NK95/36	95 +0.058	115	26	1	110	79 700	158 900	4 200	495	IR859526	NKI 85/26							
	—	—	—	—		95 +0.036	115	36	1								110	106 900	230 500	4 200	690	IR859536	NKI 85/36
100	—	—	—	—	NK100/26 NK100/36	100	120	26	1	115	82 500	168 700	4 000	525	IR9010026	NKI 90/26							
	RNA 4917	—	—	—		100	120	35	1.1								113.5	109 800	244 200	4 000	705	IR8510035	NA4917
	—	—	—	—		100 +0.058	120	36	1								115	109 800	244 200	4 000	725	IR9010036	NKI 90/36
	—	RNA 5917	—	—		100 +0.036	120	46	1.1								113.5	144 000	346 000	4 000	1 000	IR8510046	NA5917
	—	—	RNA 6917	—		100	120	63	1.1								113.5	172 600	466 800	4 000	1 300	IR8510063	NA6917

* Suitable for oil lubrication. In case of grease lubrication, down to 60% of this value.

MACHINED RING NEEDLE ROLLER BEARINGS

WITHOUT INNER RING

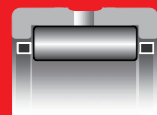

RNA49, RNA59, RNA48, NK



RNA69

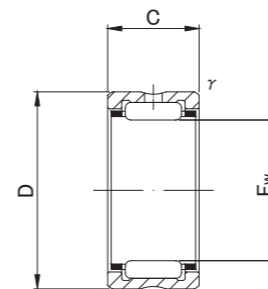

RNA49, RNA59, RNA48, NK

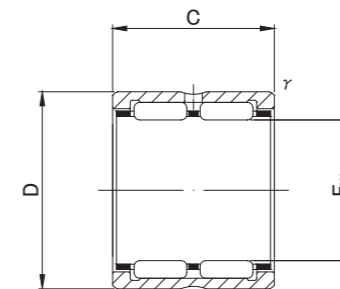

RNA69

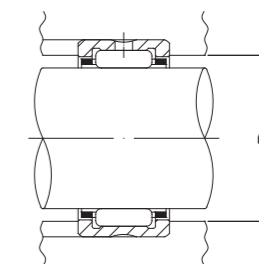

RNA49, RNA59, RNA69, RNA48, NK TYPE

Shaft Diameter (mm)	Designation					Dimensions (mm)				Standard mounting dimensions (mm)	Basic dynamic load rating	Basic static load rating	Limiting speed *	Mass	Usable bearing designation	
	RNA 49	RNA 59	RNA 69	RNA 48	NK	Fw	D	C	t/s min						Da MAX	Cr N
105	—	—	—	—	NK105/26	105	125	26	1	120	84 700	177 500	3 800	545	IR9510526	NKI 95/26
	RNA 4918	—	—	—	—	105	125	35	1.1	118.5	112 800	257 900	3 800	740	IR9010535	NA4918
	—	—	—	—	NK105/36	105 ^{+0.058}	125	36	1	120	112 800	257 900	3 800	760	IR9510536	NKI 95/36
	—	RNA 5918	—	—	—	105 ^{+0.036}	125	46	1.1	118.5	148 000	365 000	3 800	1 040	IR9010546	NA5918
	—	—	RNA 6918	—	—	105	125	63	1.1	118.5	177 500	490 300	3 800	1 360	IR9010563	NA6918
110	—	—	—	—	NK110/30	110	130	30	1.1	123.5	105 900	239 300	3 600	660	IR10011030	NKI 100/30
	RNA 4919	—	—	—	—	110	130	35	1.1	123.5	116 700	270 700	3 600	770	IR9511035	NA4919
	—	—	—	—	NK110/40	110 ^{+0.058}	130	40	1.1	123.5	133 400	323 600	3 600	880	IR10011040	NKI 100/40
	—	RNA 5919	—	—	—	110 ^{+0.036}	130	46	1.1	123.5	152 000	384 000	3 600	1 130	IR9511046	NA5919
	—	—	RNA 6919	—	—	110	130	63	1.1	123.5	182 400	514 800	3 600	1 420	IR9511063	NA6919
115	RNA 4920	—	—	—	—	115 ^{+0.058}	140	40	1.1	133.5	145 000	329 000	3 500	1 190	IR10011540	NA4920
120	—	—	—	RNA 4822	—	120 ^{+0.058}	140	30	1	135	93 000	239 000	3 500	790	IR11012030	NA4822
125	RNA 4922	—	—	—	—	125 ^{+0.068}	150	40	1.1	143.5	152 000	357 000	3 000	1 280	IR11012540	NA4922
130	—	—	—	RNA 4824	—	130 ^{+0.068}	150	30	1	145	97 000	259 000	3 000	850	IR12013030	NA4824
135	RNA 4924	—	—	—	—	135 ^{+0.068}	165	45	1.1	158.5	187 000	435 000	3 000	1 930	IR12013545	NA4924

* Suitable for oil lubrication. In case of grease lubrication, down to 60% of this value.

MACHINED RING NEEDLE ROLLER BEARINGS

WITHOUT INNER RING

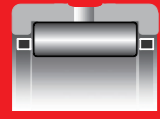

RNA49, RNA59, RNA48, NK



RNA69

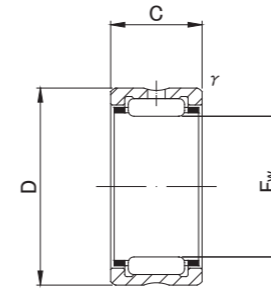

RNA49, RNA59, RNA48, NK

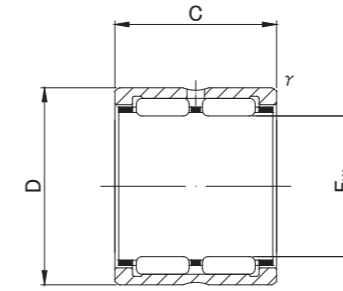

RNA69

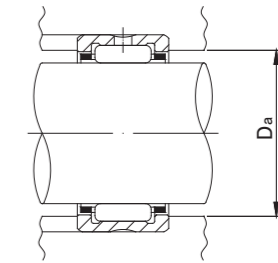

RNA49, RNA59, RNA69, RNA48, NK TYPE

Shaft Diameter (mm)	Designation					Dimensions (mm)				Standard mounting dimensions (mm)	Basic dynamic load rating	Basic static load rating	Limiting speed *	Mass	Usable bearing designation	
	RNA 49	RNA 59	RNA 69	RNA 48	NK	Fw	D	C	t/s min						Da MAX	Cr N
145	—	—	—	RNA 4826	—	145 ^{+0.068} / _{+0.043}	165	35	1.1	158.5	117 000	340 000	3 000	1 100	IR13014535	NA4826
150	RNA 4926	—	—	—	—	150 ^{+0.068} / _{+0.043}	180	50	1.5	172	216 000	540 000	2 500	2 360	IR13015050	NA4926
155	—	—	—	RNA 4828	—	155 ^{+0.068} / _{+0.043}	175	35	1.1	168.5	121 000	363 000	2 500	1 170	IR14015535	NA4828
160	RNA 4928	—	—	—	—	160 ^{+0.068} / _{+0.043}	190	50	1.5	182	224 000	580 000	2 500	2 500	IR14016050	NA4928
165	—	—	—	RNA 4830	—	165 ^{+0.068} / _{+0.043}	190	40	1.1	183.5	168 000	446 000	2 500	1 750	IR15016540	NA4830
175	—	—	—	RNA 4832	—	175 ^{+0.068} / _{+0.043}	200	40	1.1	193.5	173 000	474 000	2 500	1 850	IR16017540	NA4832

* Suitable for oil lubrication. In case of grease lubrication, down to 60% of this value.